

User's Manual

**FlexScan[®]
L461**

Color LCD Monitor

ENGLISH

SAFETY SYMBOLS

This manual uses the safety symbols below. They denote critical information. Please read them carefully.



WARNING

Failure to abide by the information in a WARNING may result in serious injury and can be life threatening.



CAUTION

Failure to abide by the information in a CAUTION may result in moderate injury and/or property or product damage.



Indicates a prohibited action.



Indicates to ground for safety.

Copyright© 2001 by EIZO NANA0 CORPORATION. All rights reserved. No part of this manual may be reproduced, stored in a retrieval system, or transmitted, in any form or by any means, electronic, mechanical, or otherwise, without the prior written permission of Eizo Nanao Corporation.

Eizo Nanao Corporation is under no obligation to hold any submitted material or information confidential unless prior arrangements are made pursuant to Eizo Nanao Corporation's receipt of said information. Although every effort has been made to ensure that this manual provides up-to-date information, please note that EIZO monitor specifications are subject to change without notice.

ENERGY STAR is a U.S. registered mark.

Apple and Macintosh are registered trademarks of Apple Computer, Inc.

VGA is a registered trademark of International Business Machines Corporation.

DPMS is a trademark and VESA is a registered trademark of Video Electronics Standards Association.

Windows is a registered trademark of Microsoft Corporation.

ScreenManager and PowerManager are trademarks of Eizo Nanao Corporation.

FlexScan and EIZO are registered trademarks of Eizo Nanao Corporation.



As an ENERGY STAR® Partner, Eizo Nanao Corporation has determined that this product meets the ENERGY STAR guidelines for energy efficiency.

TABLE OF CONTENTS

 PRECAUTIONS	4
1. INTRODUCTION	9
1-1. Features	9
1-2. Package Contents	9
1-3. Controls & Connectors	10
2. CABLE CONNECTION	11
2-1. Before connecting	11
2-2. Connecting the signal cable	12
3. ScreenManager	14
3-1. How to use the ScreenManager	14
3-2. ScreenManager Adjustments and Settings	15
3-3. Useful Functions	16
4. ADJUSTMENT	18
4-1. Screen Adjustment	18
4-2. Displaying the low resolutions	22
4-3. Color adjustment	24
4-4. Power-save Setup	26
5. ATTACHING AN ARM STAND	27
6. TROUBLE SHOOTING	29
7. CLEANING	32
8. SPECIFICATIONS	33
9. GLOSSARY	35
10. INDEX	37
APPENDIX	i



PRECAUTIONS

IMPORTANT!

- ˆ This product has been adjusted specifically for use in the region to which it was originally shipped. If operated outside the region to which it was originally shipped, the product may not perform as stated in the specifications.
- ˆ To ensure personal safety and proper maintenance. Please read this section and the caution statements on the unit (refer to the figure below).

[Location of the Caution Statements]

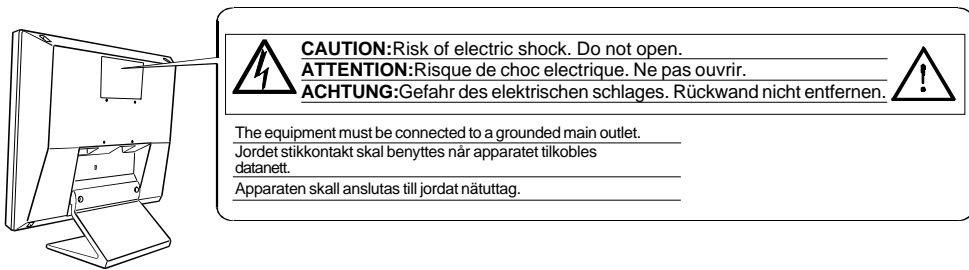

WARNING

- ˆ **If the unit begins to emit smoke, smells like something is burning, or makes strange noises, disconnect all power connections immediately and contact your dealer for advice.**

Attempting to use a malfunctioning unit can be dangerous.

- ˆ **Do not dismantle the cabinet or modify the unit.**

Dismantling the cabinet or modifying the unit may result in electric shock or burn.



- ˆ **Refer all servicing to qualified service personnel.**

Do not attempt to service this product yourself as opening or removing covers may expose you to dangerous voltage or other hazards.

⚠ WARNING

• **Keep small objects or liquids away from the unit.**

Small objects accidentally falling through the ventilation slots into the cabinet or spillage into the cabinet may result in fire, electric shock, or equipment damage. If an object or liquid falls/spills into the cabinet, unplug the unit immediately. Have the unit checked by a qualified service engineer before using it again.

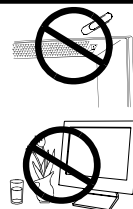

• **Place the unit on a strong, stable surface.**

A unit placed on an inadequate surface may fall, resulting in injury or equipment damage. If the unit falls, disconnect the power immediately and have the unit checked by a qualified service engineer before using it again. Using a unit after it has been dropped may result in fire or electric shock.



• **Set the unit in an appropriate location.**

Not doing so may cause damage and could result in fire or electric shock.

- * Do not place in outdoors.
- * Do not place in the transportation system (ship, aircraft, trains, automobiles, etc.)
- * Do not install in a dusty or humid environment.
- * Do not place in a location where steam can have direct contact with the screen.
- * Do not place near heat generating devices or a humidifier.

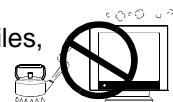

• **To avoid danger of suffocation, keep the plastic packing bags away from babies and children.**



• **Use the enclosed power cord and connect to the standard power outlet of your country. Be sure to remain within the rated voltage of the power cord.**

Not doing so may cause in fire or electric shock.

• **To disconnect the power cord, grasp the plug firmly and pull.**

Never tug on the cord, doing so may cause damage and could result in fire or electric shock.



• **The equipment must be connected to a grounded main outlet.**

Not doing so may cause in fire or electric shock.



WARNING

Use the correct voltage.

- * The unit is designed for use with a specific voltage only. Connection to another voltage than specified in this User's Manual may cause fire, electric shock, or other damage.
- * Do not overload your power circuit, as this may result in fire or electric shock.
- * For proper connections of the power cord, be certain to plug the power cord to the provided unit connector and directly to a wall outlet. Not doing so may result in fire or electric shock.

Handle the power cord with care.

- * Do not place the cord underneath the unit or other heavy objects.
- * Do not pull on or tie the cord.

If the power cord becomes damaged, stop using it. Use of a damaged cord may result in fire or electric shock.



Never touch the plug and power cord if it begins to thunder.

Touching them may result in electric shock.

When attaching an arm stand, please refer to the user's manual of the arm stand and install the unit securely with the enclosed screws.

Not doing so may cause the unit to come unattached, which may result in injury or equipment damage. When the unit is dropped, please ask your dealer for advice. Do not continue using a damaged unit. Using a damaged unit may result in fire or electric shock. When reattaching the tilt stand, please use the same screws and tighten them securely.

Do not touch a damaged LCD panel directly with bare hands.

The liquid crystal which leaks from the panel is poisonous if it enters the eyes or mouth. If any part of the skin or body comes in direct contact with the panel, please wash thoroughly. If some physical symptoms result, please consult your doctor.



Follow local regulation or laws for safe disposal.

The backlight of the LCD panel contains mercury.

⚠ CAUTION

Handle with care when carrying the unit.

Disconnect the power cord and cables when moving the unit. Moving the unit with the cord attached is dangerous. It may result in injury or equipment damage.

*** When handling the unit, grip the bottom of the unit firmly with both hands ensuring the panel faces outward before lifting.**

Dropping the unit may result in injury or equipment damage.



Do not block the ventilation slots on the cabinet.

- * Do not place books or any other papers on the ventilation slots.
- * Do not install the unit in a closed space.
- * Do not use the unit laying down or upside down.



Using the unit in these ways blocks the ventilation slots and prevents proper airflow, leading to fire or other damage.

Do not touch the plug with wet hands.

Touching the plug with wet hands is dangerous and can cause electrical shock.



Use an easily accessible power outlet.

This will ensure that you can disconnect the power quickly in case of a problem.

Periodically clean the area around the plug.

Buildup of dust, water, or oil on the plug may result in fire.

Unplug the unit before cleaning it.

Cleaning the unit while it is plugged into a power outlet may result in electric shock.

If you plan to leave the unit unused for an extended period, disconnect the power cord from the wall socket after turning off the power switch for the safety and the power conservation.

Suggestions for Maximizing Comfort

- ˆ To lessen the chance of possible injury and to increase your comfort and productivity while you operate the unit, we suggest the followings:
 - * Avoid less favorable body positioning. Sit back on the chair with your back straight.
 - * Adjust the height of the chair so that the both soles touch the floor.
 - * Adjust the height of your chair, unit, or keyboard so that you can keep your wrists straight while typing.
 - * Set the unit slightly below eye level.
- ˆ Adjust brightness of the screen depending on the brightness of your environment. Too dark or too bright of a screen can cause eyestrain.
- ˆ Be sure to take adequate rests. A 10-minute rest period each hour is suggested.



LCD Panel

- ˆ The screen may have defective pixels. These pixels may appear as slightly light or dark area on the screen. This is due to the characteristics of the panel itself, and not the product.
- ˆ The backlight of the LCD panel has a fixed life span. When the screen becomes dark or begins to flicker, please contact your dealer.
- ˆ Do not press on the panel or edge of the frame strongly, as this will result in damage to the screen. There will be prints left on the screen if the pressed image is dark or black. If pressure is repeatedly applied to the screen, it may deteriorate or damage your LCD panel. Leave the screen white to decrease the prints.
- ˆ Do not scratch or press on the panel with any sharp objects, such as a pencil or pen as this may result in damage to the panel. Do not attempt to brush with tissues as this may scratch the LCD panel.



1. INTRODUCTION

Thank you very much for choosing an EIZO Color Monitor.

1-1. Features

- 1280 x 1024 resolution ^{p.36)} incorporated 16 inch Color LCD Monitor
- DVI ^{p.35)} digital input (TMDS ^{p.36)} compliant
- Horizontal scanning frequency of 31.5 ~ 80kHz
Horizontal (Digital): 31.5 ~ 64 kHz
Vertical scanning frequency of 50 ~ 85 Hz (1280 x 1024 ~ 75Hz)
Vertical (Digital): 60 Hz (VGA Text: 70 Hz)
- Auto Adjustment compliant and original "Picture Adjustment Program" software included
- ColorManagement function incorporated

1-2. Package Contents

Please contact your local dealer for assistance if any of the listed items are missing or damaged.

- LCD Monitor

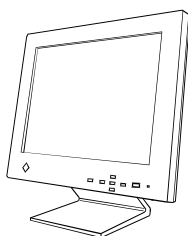

- Power Cord

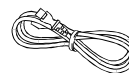

- Signal Cable (FD-C16)

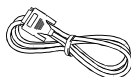

- 4 of M4 x 16 mm mounting screws



- EIZO LCD Utility Disk



- User's Manual

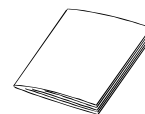

- Quick Reference



- Limited Warranty



NOTE

- Please retain the packing materials for future transference.

1-3. Controls & Connectors

Front

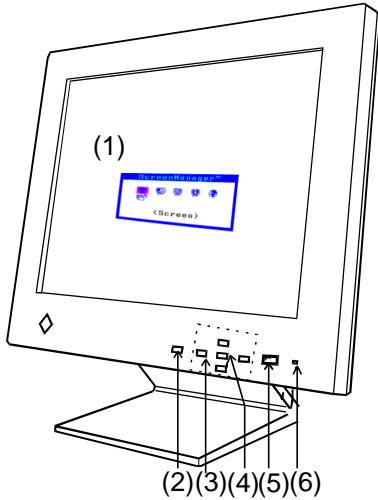

- (1) ScreenManager™
- (2) AUTO Adjustment button
- (3) Control Buttons
- (4) Enter Button
- (5) Power Switch
- (6) Power Indicator*¹

Indicated color	Monitor's status
Green	Power -on
Yellow	Power save mode
Flashing Yellow (2 times for each)	Power save mode for digital
Slowly flashing Yellow	Power is off

Rear

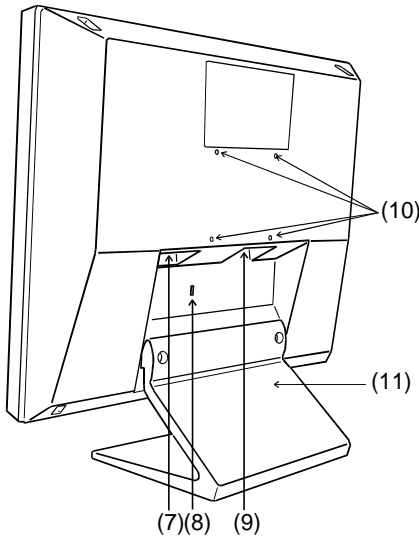

- (7) Power Connector
- (8) Security Lock Slot*²
- (9) DVI-I Input Connector
- (10) 4 Holes for Mounting an Arm-Stand*³
- (11) Stand (Detachable)*³

*¹ Regarding the power indicator for the “Off Timer”, see page 17.

*² Allows for connection of a security cable. This lock supports Kensington’s MicroSaver security system. For further information, please consult:

Kensington Technology Group 2855 Campus Drive, San Mateo, CA 94403 USA
800-650-4242, x3348

Intl: 650-572-2700, x3348 / Fax: 650-572-9675

<http://www.kensington.com>

*³ The L461 can be used with an optional arm stand by removing the original stand (see page 27).

2. CABLE CONNECTION

2-1. Before connecting

Before connecting your monitor to the PC, change the display screen settings (resolution and frequency) in accordance with the charts below.

Analog Input

Resolution	Frequency	Remarks
640 x 480	~ 85 Hz	VGA, VESA
640 x 480	66.67 Hz	Apple Macintosh
720 x 400	70 Hz	VGA Text
800 x 600	~ 85 Hz	VESA
832 x 624	75 Hz	Apple Macintosh
1024 x 768	~ 85 Hz	VESA
1152 x 864	75 Hz	VESA
1152 x 870	75 Hz	Apple Macintosh
1280 x 960	75 Hz	Apple Macintosh
1280 x 1024	~ 75 Hz	VESA

NOTE

- About Plug & Play of the monitor
When your computer and display support VESA DDC, the suitable resolution and the refresh rate are set by just plugging your display into the computer without any manual settings. When your computer system supports Plug & Play, the Display Information File is not required except for installing the Color Profile.

Digital Input

Only the following resolutions with frequency can be displayed on this model.

Resolution	Frequency	Remarks
640 x 480	60 Hz	VGA
720 x 400	70 Hz	VGA Text
800 x 600	60 Hz	VESA
1024 x 768	60 Hz	VESA
1280 x 960	60 Hz	VESA
1280 x 1024	60 Hz	VESA

2-2. Connecting the signal cable

NOTE

- Be sure that the power switches of both the PC and the monitor are OFF.

1. Plug the signal cable into the DVI-I connector at the rear of the monitor and the other end of the cable into the video connector on the PC.

After connecting, secure the connection with the screw-in fasteners.

[Analog Input]

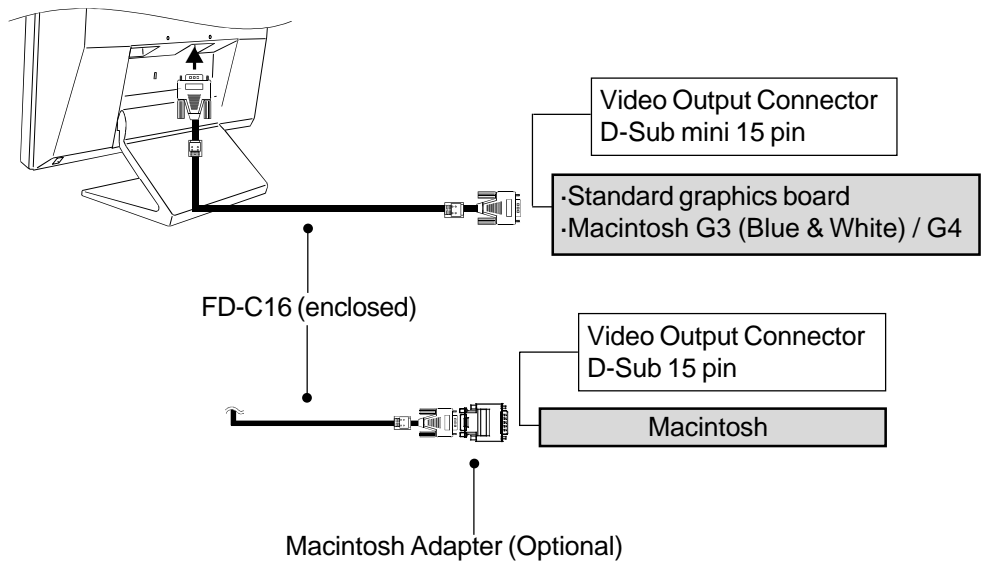

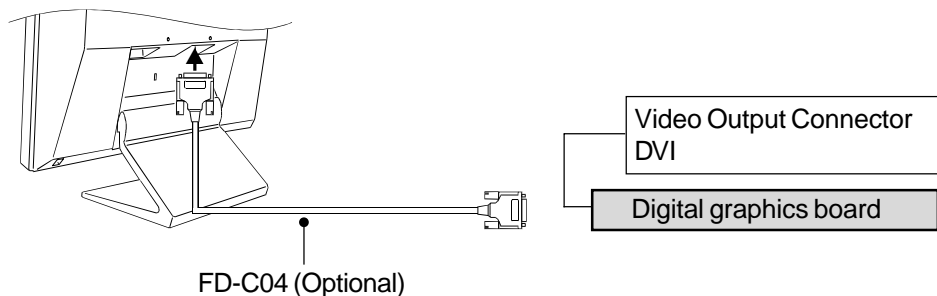

[Digital Input]



NOTE

- The L461 is not compatible with a Power Macintosh G4/G4 Cube ADC (Apple Display Connector).

-
- 2. Plug the power cord into the power connector on the rear of the monitor and plug the other end of the power cord into a power outlet.**

 WARNING	
<ul style="list-style-type: none">• Use the enclosed power cord and connect to the standard power outlet of your country. Be sure to remain within the rated voltage of the power cord. Not doing so may cause in fire or electric shock.	
<ul style="list-style-type: none">• The equipment must be connected to a grounded main outlet. Not doing so may cause in fire or electric shock.	

- 3. Turn on the monitor's power and then switch on the PC's power.**
Whenever finished, turn off the PC and the monitor.

3. ScreenManager

3-1. How to use the ScreenManager

As shown on the display, the ScreenManager is used to adjust the LCD monitor. ScreenManager consists of main menus and sub menus. Adjustments are made using the Enter and Control buttons (up, down, right and left) located on the front panel.

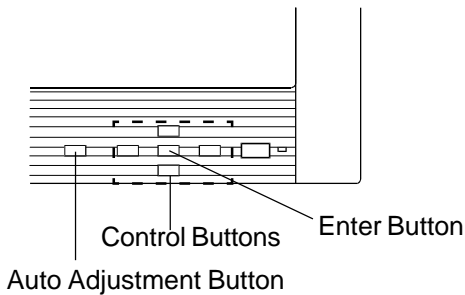

1. Entering the ScreenManager

Push the Enter Button once to display the main menu of the ScreenManager.

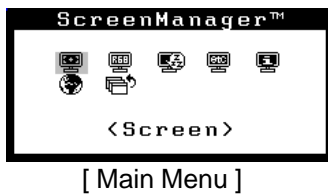

2. Making Adjustments and Settings

- (1) Select the desired sub menu icon using the Control buttons and push the Enter button. The sub menu appears.
- (2) Use the Control buttons to select the desired setting icon and push the Enter button. The setting menu appears.
- (3) Use the Control buttons to make all required adjustments and push the Enter button to save the settings.

3. Exiting the ScreenManager

- (1) To return to the main menu, select the "Return" icon or push the down button twice, followed by the Enter button.
- (2) To exit the ScreenManager, select "Exit" icon and push the Enter button.

NOTE

- Double clicking the Enter button at any time also exits the ScreenManager menu.

3-2. ScreenManager Adjustments and Settings.

The following table shows all the ScreenManager's adjustment and setting menus. "*" indicates adjustments of analog input only and "***" indicates digital input only.

Main menu	Sub menu	Reference	
Screen	Clock*	4. ADJUSTMENT(p.18)	
	Phase*		
	Position*		
	Resolution*		
	Smoothing		
	Contrast/Brightness		
Color-Management	Range Adjustment*		
	Standard Mode		Temperature
	Custom Mode		Temperature
			Saturation
			Hue
			Gain
Save			
PowerManager	DVI DMPM**		
	VESA DPMS*		
Others	Screen Size		
	Border Intensity		
	Off Timer	Set the monitor's off timer to on or off. (p.17)	
	Menu Position	Adjust the menu position.	
	Menu Off Timer	Set the menu displaying time.	
	Translucent	Set the transparency of the white background for the menu.	
	Reset	Return to the factory default settings. (p.34)	
Information	Information	Review the ScreenManager's settings, model name, Serial Number and usage time ^{*1} .	
Language	English, German, French, Spanish, Italian, Swedish and Japanese	Select the ScreenManager's language.	

^{*1} Due to the inspection on the factory, the usage time may not "0 hour" at shipping.

3-3. Useful Functions

Adjustment Lock

Use the “Adjustment Lock” function to prevent any accidental changes.

Locked function	• Auto adjustment button adjustments and settings in the ScreenManager.
Unlocked function	• Adjustment of contrast and brightness by the control buttons.

- To lock
Press on the Auto adjustment button while switching on the monitor’s power switch on the front panel.
- To unlock
Switch off the monitor’s power by the power switch on the front panel, then hold down the Auto adjustment button once again and turn the power back on.

EIZO Logo Disappearing function

When switching on the power, the EIZO logo is displayed for a while. If you desire to undisplay this logo, use this function.

- To undisplay
Switch off the monitor’s power by the power switch on the front panel. Turn the power back again with pressing the enter button on the front panel.
- To display again
Switch off the monitor’s power by the power switch on the front panel. Turn the power back again with pressing the enter button on the front panel.

Off Timer

The off timer function causes the monitor to automatically enter a power off mode after a predetermined amount of time has lapsed. This function was created to reduce afterimage ^{p.35)} characteristics that are particular to LCD monitors when the monitor screen is left on for a long period without use.

[Procedure]

- (1) Select "Off Timer" in the ScreenManager "Others" menu.
- (2) Select "Enable" and press the right and left buttons to adjust the "On Period" (1 to 23 hours).

[Off timer system]

PC	Monitor	LED
On Period (1H~23H)	Operation	Green
Last 15 min. in "On period"	Advance Notice ^{*1}	Green Flashing
"On period" expired	"Power Off" Mode	Flashing yellow slowly

^{*1}Advance notice (LED flashing green) will be given 15 minutes before the monitor automatically enters the "Power Off" mode. To delay entering the "Power Off" mode, press the power switch during the advance notice period. The monitor will continue to operate for an additional 90 minutes.

Press the power switch to return to a normal screen.

NOTE

- The off timer function works while the PowerManager is active, but there is no advance notice before the monitor's power is switched off.

4. ADJUSTMENT

4-1. Screen Adjustment

NOTE

- Allow the LCD monitor to stabilize for at least 20 minutes before making image adjustments.

Screen adjustments for the LCD monitor should be used in suppressing screen flickering and also for adjusting the screen to its proper position. There is only one correct position for each display mode. When using the analog input, it is also recommended to use the ScreenManager function when first installing the display or whenever changing the system. For convenience, an easy set-up Program installed on the utility disk to assist in the set-up procedure is provided.

When using the digital input, the monitor displays the digital input image correctly based on its pre-setting data. Please adjust the contrast and brightness as desired with referring page 21.

1. Push the Auto adjustment button on the front panel.

The message “Your setting will be lost, if you press again now.” appears and remains on the screen for 5 seconds. While the message is on the screen, push the Auto adjustment button again to automatically adjust the clock, phase, screen position and resolution. If you do not wish to do adjust the screen, do not push the Auto adjustment button again.

If the appropriate screen can not be made by using the Auto adjustment button, adjust the screen through the following procedures.

2. Install the “Screen adjustment program”.

Having read the “readme.txt” file, install and run the “Screen adjustment program” in the enclosed EIZO LCD utility disk.

Step by step adjustment is provided by the wizard guide.

NOTE

- If the user’s operating system has no utility disk (e.g. OS/2), we recommend setting the desktop pattern to that as shown in the diagram below.

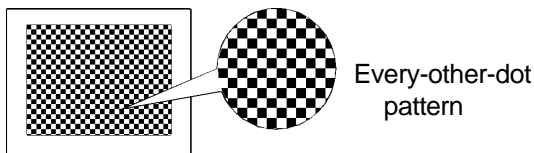

3. Adjust by using “Screen” menu in the ScreenManager.

(1) Vertical bars appear on the screen.

→  Use the “Clock” ^{p.35)} adjustment

Select the “Clock” and eliminate the vertical bars by using the right and left of the control buttons. Do not continuously press the control buttons, as the adjustment value will change quickly and make it difficult to locate the most suitable adjustment point.

If the horizontal flickering, blur or bars appear, proceed to “Phase” adjustment as follows.

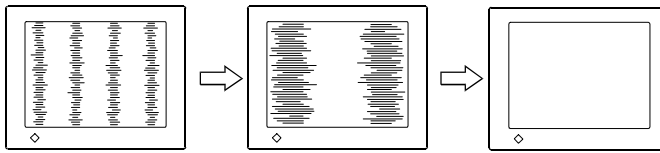

NOTE

- When adjusting the “Clock,” the horizontal screen size will also change.

(2) Horizontal flickering, blurring or bars appear on the screen.

→  Use the “Phase” ^{p.36)} adjustment.

Select the “Phase” and eliminate the horizontal flickering, blurring or bars by using the right and left buttons.

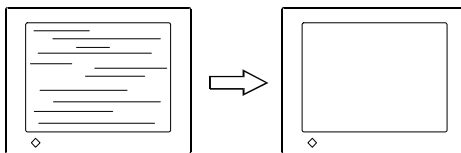

NOTE

- Horizontal bars may not completely disappear from the screen depending on the PC.

(3) The screen position is incorrect.

→  Use the “Position” adjustment.

The correct displayed position of LCD monitor is decided because the number and the position of the pixels are fixed. The “Position” adjustment moves the image to the correct position.

Select “Position” and adjust the position so all the dotted line appear around screen, by using the up, down, right and left buttons.

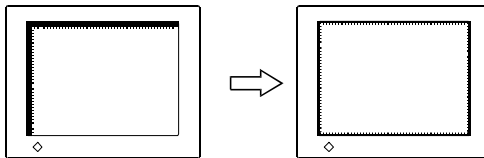

(4) Screen image is smaller or larger than the actual screen images.

→  Use the “Resolution” adjustment.

Adjustment is needed when the input signal resolution and the resolution now being displayed is different.

Select “Resolution” and confirm if the resolution now being displayed is the same as the input resolution. If it is not, adjust the vertical resolution using the up and down button and adjust the horizontal resolution using the right and left buttons.

Smaller than the actual screen images.

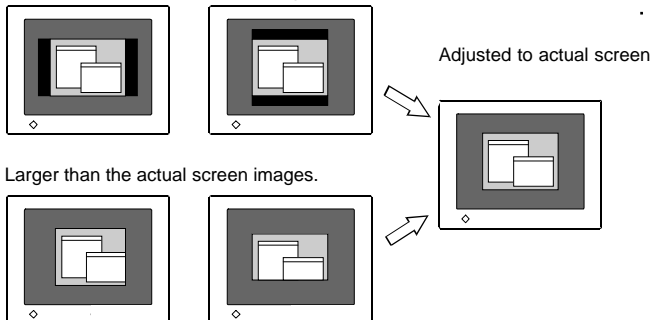

Larger than the actual screen images.

4. To set the Output signal range (Dynamic Range) of the signal.

→  Use the “Range Adjustment” .^{p.36}

This controls the level of output signal range to display the whole color gradation (256 colors). Select the “Range Adjustment” in the “ColorManagement” menu.

[Auto]

Push the Auto adjustment button on the front panel while displaying the “Range adjustment” menu to automatically adjust the range. The screen blanks for a moment, and adjusts the color range to display the whole color gradation of the current output signal.

NOTE

- Pressing Auto adjustment button while displaying the contrast/brightness adjustment screen (appeared by pressing the control buttons directly) adjusts the range automatically.

5. To set the Contrast of the screen.

→  Use the “Contrast” adjustment.

This controls the brightness for the each color (red, blue and green) at a same time.

Select “Contrast/Brightness” in the screen menu and adjust by using the right and left buttons.

6. To set the Brightness of the screen.

→  Use the “Brightness” adjustment.

This controls the brightness for the entire screen. The brightness of the entire screen is controlled by changing the brightness if the backlight.

Select “Contrast/Brightness” in the screen menu and adjust by using the up and down buttons.

NOTE

- Directly pressing the control buttons also adjusts the contrast and brightness. Press the “Enter” button to save and exit the settings after the adjustment.

4-2. Displaying the low resolutions

The lower resolutions are enlarged to full screen automatically. Using the “ScreenSize” function in the “Others” menu enables to change the screen size.

1. To enlarge the screen size when displaying a low resolution.

→  Select “Screen Size”

Select the “Screen Size” in the others menu and select the screen size by using the up and down buttons.

• Full	Displays the picture on the screen in full, irrespective of the picture’s resolution. Since the vertical resolution and the horizontal resolution are enlarged at different rates, some images may appear distorted.
• Enlarged	Displays the picture on the screen in full, irrespective of the picture’s resolution. Since the vertical resolution and horizontal resolution are enlarged at same rates, some horizontal or vertical image may disappear.
• Normal	Displays the picture at the actual Screen resolution.

Example: Displaying 1024 x 768

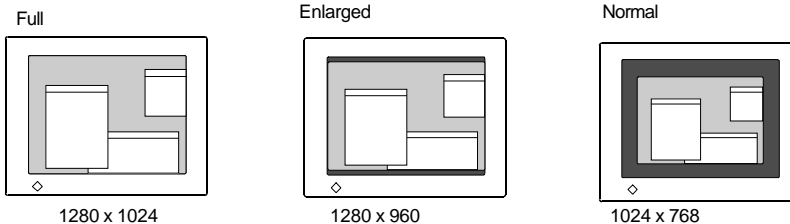

2. To be clear-cut the letters or lines of the enlarged screen.

→  Switch the “Smoothing” setting.

Select “Smoothing” in the screen menu and switch the setting to “Off” by using the left button.

NOTE

- “Smoothing” is disabled in the following cases.
 - * 1280 x 1024 of resolution
 - * “Enlarged” mode in “Screen Size” setting with the 1280 of the horizontal resolution (i.e. 1280 x 960)
 - * “Normal” mode in the “Screen Size” setting

3. To set the brightness of the black area surrounding the image.

→  Set the “Border Intensity”

In the “Normal” mode, the outer area (border) is usually black.

Select “Border Intensity” in the others menu and adjust by using the right and left buttons.

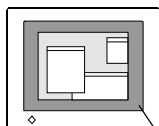

Border

4-3. Color Adjustment

The “ColorManagement” menu in the ScreenManager enables to change the color of the screen.

Before the Color adjustment

- Allow the LCD monitor to stabilize for at least 20 minutes before making color adjustments.
- After finishing each adjustment in the custom mode, select “Save” icon to register the adjustment. Otherwise, the adjustment will be lost.
- The adjustment values represent the current level within the specific adjustment only. They are available only as a reference tool. (To create a uniform white or black screen, the percentages for each will probably not be the same.)
- In the analog input, perform the “Range Adjustment” (p.21) before making the color adjustments . The gradation pattern like below is recommended for the “Range Adjustment”.

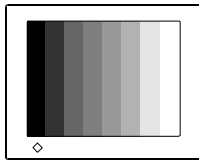

1. To change the color tone of the white.

→ K Set the “Temperature”.^{p.35)}

The “Temperature” can be set from 4,000 K to 10,000 K , in 500 K increments (including 9,300 K). The default setting is “OFF”.

To register the adjustment in the custom mode, select the “Save” icon and then push the enter button.

NOTE

- Setting the temperature under 4,000 K or over 10,000 K invalidates the color temperature setting. (The color temperature’s setting turns “OFF”.)
- Adjusting the “Gain” (p. 25) invalidates the color temperature setting. (The color temperature’s setting turns “OFF”.)

2. To change the saturation.

→  Use the “Saturation” adjustment.

The “Saturation” can be selected from -64 to 64. Setting the minimum level (-64) turns the image to the monochrome.

To register the adjustment, select the “Save” icon and then push the enter button.

NOTE

- The “Saturation” adjustment may cause undisplayable color tone.

3. To change the flesh color, etc.

→  Use the “Hue” adjustment.

The “Hue” can be selected from -16 to 16.

To register the adjustment, select the “Save” icon and then push the enter button.

NOTE

- The “Hue” adjustment may cause undisplayable color tone.

4. To adjust each color (red, green and blue).

→  Use the “Gain”^{p.35} adjustment.

By adjusting the red, green and blue color tones for each mode, custom colors can be defined.

The 100 % indicates unadjusted condition.

Display a white or gray background image and adjust the “Gain”.

To register the adjustment, select the “Save” icon and then push the Enter button.

NOTE

- The “Gain” adjustment may cause undisplayable color tone.
- Adjusting the “Gain” invalidates the color temperature setting. (The color temperature’s setting turns “OFF”.)

4-4. Power-save Setup

NOTE

- Do your part to conserve energy, turn off the monitor when you are finished using it. Disconnecting the monitor from the power supply is recommended to save energy completely.

Analog Input

This monitor complies with the VESA DPMS ^{p.36)} standard.

1. Set the PC's power saving settings.
2. Select "VESA DPMS" in the "PowerManager" menu.

[Power saving system]

PC		Monitor	LED
On		Operation	Green
Power saving mode	STAND-BY SUSPEND OFF	Power saving	Yellow

Operate the mouse or keyboard to return to a normal screen.

Digital Input

This monitor complies with the DVI DMPM ^{p.35)}.

1. Set the PC's power saving settings.
2. Select "DVI DMPM" in the "PowerManager" menu.

[Power saving system]

PC	Monitor	LED
On	Operation	Green
Power saving	Power saving	Yellow
Off mode	Power saving	Flashing yellow (2 times for each)

Operate the mouse or keyboard to return to a normal screen from the Power save mode of the PC. Power on the PC to return a normal screen from the Off mode of the PC.

5. ATTACHING AN ARM STAND

The L461 can be used with an arm stand by removing the tilt stand and attaching the arm stand to the terminal.

NOTE

- ˆ Use an arm stand that satisfies the followings.
- When using the L461 with an arm stand, the arm stand must be VESA approved :
 - * Use an arm stand with a 75 mm x 75 mm hole spacing on the arm mounting pad.
 - * Use an arm stand that is able to support an object weighting 8.0 kg.
- ˆ TÜV/GS approved arm stand.
- ˆ Use an arm stand with sufficient stability (mechanical firmness) to support the weight of the monitor.
- ˆ Use an arm stand remaining that position where it is manually moved.
- ˆ Use an arm stand with the ability to tilt the monitor forward and backward.
- ˆ Please connect cables after attaching an arm stand.

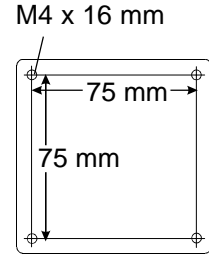

Setup Procedure

1. Lay the L461 down as shown below. Do not scratch the panel.

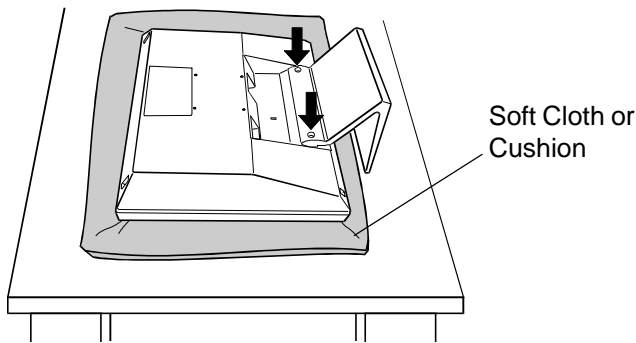

2. Remove the tilt stand by loosening the screws (2 pcs of M4 x 10 mm).

3. Attach an arm stand to the L461 securely.

⚠ WARNING

When attaching an arm stand, please refer to the user's manual of the arm stand and install the unit securely with the enclosed screws.

Not doing so may cause the unit to come unattached, which may result in injury or equipment damage. When the unit is dropped, please ask your dealer for advice. Do not continue using a damaged monitor. Using a damaged monitor may result in fire or electric shock.

When reattaching the tilt stand, please use the same screws and tighten them securely.

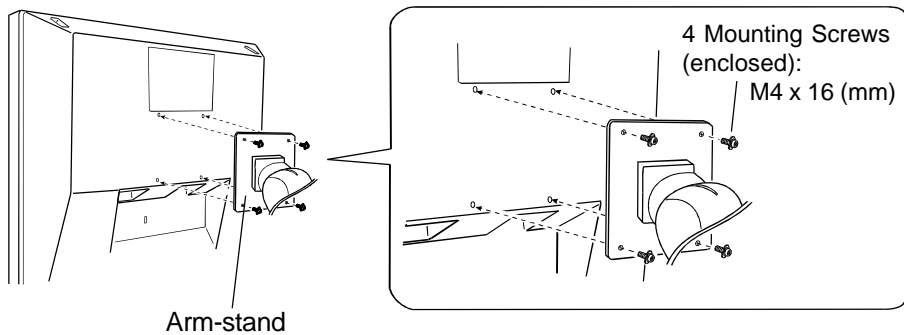

NOTE



For the Portrait display, rotate the monitor clockwise and use the software for the portrait.

6. TROUBLESHOOTING

If a problem persists even after applying the suggested remedies, contact an EIZO dealer.

- No picture problems → See No.1 ~ No.2
- Imaging problems → See No.3 ~ No.11
- Other problems → See No.12 ~ No.16

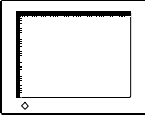
Problems	Points to check with possible solutions
<p>1. No picture</p> <ul style="list-style-type: none"> • Indicator status: Off 	<ul style="list-style-type: none"> <input type="checkbox"/> Check that the power cord is correctly connected. <input type="checkbox"/> If the problem persists, turn off the monitor power for a few minutes, then turn it back on and try again.
<ul style="list-style-type: none"> • Indicator status: Green • Indicator status: Yellow • Indicator status: Slowly flashing Yellow 	<ul style="list-style-type: none"> <input type="checkbox"/> Check the “Contrast and Brightness” settings. Minimum settings will cause screen to be blank. <input type="checkbox"/> Try pressing a key on the keyboard, or clicking the mouse. (p.26) <input type="checkbox"/> Try pressing the power switch.
<p>2. Following messages appear. (Error messages will remain on the screen for 40 seconds.)</p> <div style="border: 2px solid blue; padding: 5px; margin: 10px 0;"> <p style="text-align: center; color: blue; font-weight: bold;">Signal Check</p> <p style="text-align: center; color: blue;">Input Signal</p> <p style="text-align: center; color: red;">No Signal</p> </div>	<p>These messages appear when the signal is not inputted correctly, even if the monitor functions properly.</p> <ul style="list-style-type: none"> <input type="checkbox"/> When the image is displayed correctly after a short time, there is no problem with the monitor. (Some PCs do not output the signal soon after powering on.) <input type="checkbox"/> Check that the PC is turned ON. <input type="checkbox"/> Check that the signal cable is properly connected to the PC or graphics board.
<ul style="list-style-type: none"> • Whenever an error signal message appears, the signal frequency will be displayed in red. (Example) <div style="border: 2px solid blue; padding: 5px; margin: 10px 0;"> <p style="text-align: center; color: blue; font-weight: bold;">Signal Error</p> <p style="text-align: center; color: blue;">Input Signal</p> <p style="text-align: center; color: red;">fH: 110.0kHz</p> <p style="text-align: center; color: red;">fV: 75.0Hz</p> </div>	<ul style="list-style-type: none"> <input type="checkbox"/> Use the graphics board’s utility software to change the frequency setting. (Refer to the manual of the graphics board.)

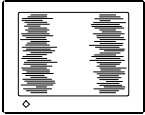
Problems	Points to check with possible solutions
<p>3. Display position is incorrect.</p> 	<ul style="list-style-type: none"> <input type="checkbox"/> Adjust the image position using the “Position”. (p.20) <input type="checkbox"/> If the problem persists, use the graphics board’s utility software to change the display position if available.
<p>4. Screen image is smaller or larger than the actual screen images.</p>	<ul style="list-style-type: none"> <input type="checkbox"/> Adjust the resolution using the “Resolution”. (p.20)
<p>5. Vertical bars of distortion appear.</p> 	<ul style="list-style-type: none"> <input type="checkbox"/> Decrease the vertical bars using the “Clock”. (p.19)
<p>6. Horizontal bars of distortion appear.</p> 	<ul style="list-style-type: none"> <input type="checkbox"/> Decrease the horizontal bars using the “Phase”. (p.19)
<p>7. Letters and lines appear blurred.</p>	<ul style="list-style-type: none"> <input type="checkbox"/> Switch the “Smoothing” mode to “Off”. (p.23)
<p>8. The screen is too bright or too dark.</p>	<ul style="list-style-type: none"> <input type="checkbox"/> Adjust the “contrast and brightness”. (The backlight of the LCD monitor has a fixed life span. When the screen becomes dark or begins to flicker, please contact your dealer.)
<p>9. Afterimages appear.</p>	<ul style="list-style-type: none"> <input type="checkbox"/> When the screen image is changed after displaying the same image for a long period, an afterimage may appear. Use the “Off Timer” function and avoid keeping the screen on all the time. (p.17)
<p>10. The screen has defective pixels (e.g. slightly light or dark).</p>	<ul style="list-style-type: none"> <input type="checkbox"/> This is due to the characteristics of the panel itself, and not the LCD product.

Problems	Points to check with possible solutions
11. Fingerprints remain on the screen.	<input type="checkbox"/> Leaving the screen white may solve the problem.
12. The “Smoothing” can not be selected.	<input type="checkbox"/> “Smoothing” is disabled in the following cases. <ul style="list-style-type: none"> • 1280 x 1024 of resolution • “Enlarged” mode in the “Screen Size” setting with the 1280 of horizontal resolution (i.e. 1280 x 960) • “Normal” mode in the “Screen Size” setting.
13. The utility disk is unable to be opened (for Macintosh only).	<input type="checkbox"/> Some Macintosh without PC-Exchange do not allow the utility disk to be opened. Please set the desktop pattern to every-other-dot before adjustment. (p.18)
14. • The Enter button does not operate. • The Auto adjustment button does not operate.	<input type="checkbox"/> The adjustment lock is probably on. To unlock: switch the LCD monitor off. Then, while pressing the Auto adjustment button, switch the power on. (p.16)
15. The Auto adjustment button does not work properly.	<input type="checkbox"/> The Auto sizing function is intended for use on the Macintosh and on AT-compatible PC running Windows. It may not work properly in either of the following cases. When running an AT-compatible PC on MS-DOS (Not windows). The background color for the “wall paper” or “desktop” pattern is set to black. Some signals from a graphics board may not function properly.
16. Frequency does not change after installing “Monitor information file” in the attached utility disk on Windows 95/98/Me/2000.	<input type="checkbox"/> Use the graphics board’s utility software to change the input signal frequency.

7. CLEANING

Periodic cleaning is recommended to keep the monitor looking new and to prolong its operation lifetime.

NOTE

- **Never use thinner, benzene, alcohol (ethanol, methanol, or isopropyl alcohol), abrasive cleaners, or other strong solvents, as these may cause damage to the cabinet or LCD panel.**



Cabinet

To remove stains, wipe the cabinet with a soft, lightly moistened cloth using a mild detergent. Do not spray wax or cleaner directly onto the cabinet.

LCD Panel

The LCD surface can be cleaned with a soft cloth, such as cotton or lens paper.

If necessary, stubborn stains can be removed by moistening part of a cloth with water to enhance its cleaning power.

8. SPECIFICATIONS

LCD Panel	41 cm (16.0 inch), TFT color LCD Panel with Anti-Glare Hard Coating Viewing Angle: Horizontal: 130°, Vertical: 160° (at Contrast Ratio \geq 5)
Dot Pitch	0.248 mm
Scan Frequency	Horizontal: 31.5kHz - 80 kHz (Automatic) Vertical: 50 Hz-85 Hz (Automatic) (1280 x 1024: up to 75 Hz) Horizontal (Digital): 31.5kHz - 64 kHz Vertical (Digital): 60Hz (VGA text: 70Hz)
Resolution	1280 dots x 1024 lines
Dot Clock (Max)	135 MHz 108 MHz(Digital)
Display Colors	16 million colors (max)
Display Area	317.4 mm (H) x 253.9 mm (V) (12.5" (H) x 10.0" (V)) (Viewable image size: 406 mm (16.0"))
Power Supply	100-120/200-240 VAC \pm 10%, 50/60 Hz, 0.7 A/0.4 A
Power Consumption	Normal: 40 W Power Saving Mode: Less than 3 W
Input Connector	DVI-I x 1
Input Signal	Analog Sync Separate, TTL, Positive/Negative Video : 0.7 Vp-p/75 Ω , Positive Digital TMDS (Single Link)
Signal registration	35 (Analog Factory Preset: 21)
Plug & Play	VESA DDC 2B
Dimensions	384 mm (W) x 387.2 mm (H) x 171.4 mm (D) (15.1" (W) x 15.0" (H) x 6.7" (D))
Dimensions (without stand)	384 mm (W) x 325 mm (H) x 69 mm (D) (15.1" (W) x 12.8" (H) x 2.7" (D))
Weight	5.7 kg (12.6 lbs.)
Weight(without stand)	4.3 kg (9.5 lbs.)
Temperature	Operating: 0°C to 35°C (32°F to 95°F) Storage: -20°C to 60°C (-4°F to 140°F)
Humidity	30% to 80% R.H. Non-condensing

Dimensions

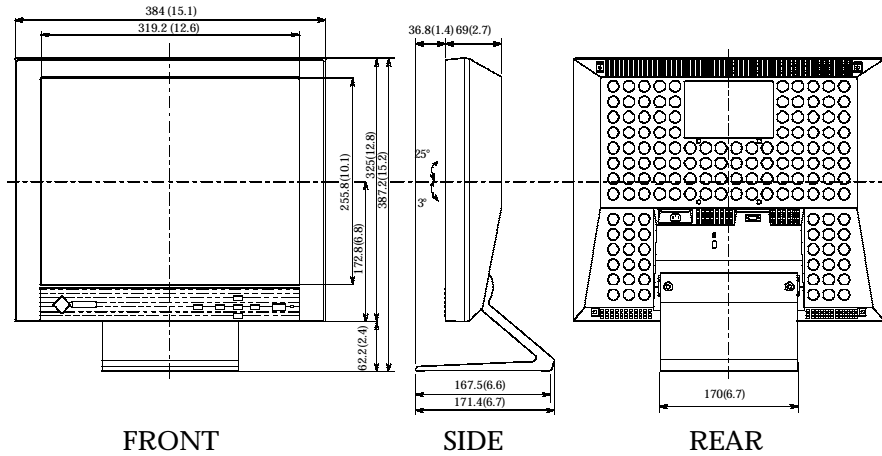

Default Settings

Default Settings are as follows:

ScreenManager menu	Default Settings
Contrast	100%
Brightness	100%
Smoothing	On
Color Mode	Standard
Temperature	Off
PowerManager	VESA DPMS DVI DMPM(Digital Input)
Screen Size	Full Screen
Off Timer	Disable
Menu Off Timer	45 seconds
Language	English

9. GLOSSARY

Afterimage

The Afterimage is particular to LCD monitors when the monitor screen is left on for a long period without use. The “Afterimage” can be removed gradually by changing the displayed image.

Clock

With the analog input signal display, the analog signal is converted to a digital signal by the LCD circuitry. To convert the signal correctly, the LCD monitor needs to produce the same number clock pulse as the dot clock of the graphics system. When the clock pulse is not correctly set, some vertical bars of distortion are displayed on the screen.

Color Temperature (Temperature)

Color Temperature is a method to measure the white color tone, generally indicated in degrees Kelvin. At high temperatures the white tone appears somewhat blue, while at lower temperatures it appears somewhat red. Computer monitors generally give best performance at high temperature settings.

5000K: Slightly reddish white.

6500K: Warm-white tone, similar to white paper or daylight.

9,300K: Slightly bluish white.

DVI

(Digital Visual Interface)

A digital flat panel interface. DVI can transmit digital data from the PC directly without loss with the signal transition method “TMDS”. There are two kinds of DVI connectors. One is DVI-D connector for digital signal input only. The other is DVI-I connector for both digital and analog signal inputs.

DVI-DMPM

(DVI Digital Monitor Power Management)

The Power management system for the digital interface. The “Monitor ON” status (operation mode) and the “Active Off” status (power-saving mode) are indispensable for the DVI-DMPM as the monitor’s power mode.

Gain Adjustment

Adjusts each color parameter for red, green and blue. The color of the LCD monitor is displayed through the color filter of the LCD panel. Red, green and blue are the three primary colors. The colors on the monitor are displayed by combining these three colors. The color tone can change by adjusting the illumination amount passed through each color’s filter.

Phase

The phase adjustment decides the sampling timing point for converting the analog input signal to a digital signal. Adjusting the phase after the clock adjustment will produce a clear screen.

Range Adjustment

The Range Adjustment controls the level of output signal range to display the whole color gradation.

Resolution

The LCD panel consists of a fixed number of pixel elements which are illuminated to form the screen image.

The EIZO L461 consists of 1280 horizontal pixels and 1024 vertical pixels. At a resolution of 1280 X 1024, all pixels are used and the image is displayed as a full screen. At the lower display modes of 640 x 480 or 800 x 600, the images are displayed in the center of the screen using a smaller portion of the pixels.

TMDS

(Transition Minimized Differential Signaling)

A signal transition method for the digital interface.

VESA DPMS

The acronym VESA stands for “Video Electronics Standards

Association,” and DPMS stands for “Display Power Management Signaling.”

DPMS is a communication standard that PCs and graphics boards use to implement power savings on the monitor side.

10. INDEX

A

ADJUSTMENT ----- 18
Adjustment Lock ----- 16
Afterimage ----- 17,35
ATTACHING AN ARM STAND ----- 27

B

Before connecting ----- 11
Border Intensity ----- 15, 23
Brightness ----- 15, 21

C

CABLE CONNECTION ----- 11
CLEANING ----- 32
Clock ----- 15, 19, 35
Color Adjustment ----- 24
ColorManagement ----- 15, 21, 24
Contrast ----- 15, 21
Controls & Connectors ----- 10
Custom Mode ----- 15

D

Default setting ----- 34
Dimensions ----- 34
Displaying the low resolutions ----- 22
DVI ----- 9, 35
DVI-DMPM ----- 15, 26, 35

E

EIZO LCD utility disk ----- 9, 18
EIZO Logo Disappearing function ----- 16

G

Gain ----- 15, 25, 35
GLOSSARY ----- 35

H

How to use the ScreenManager ----- 14
Hue ----- 15, 25

I

Information ----- 15

L

Language ----- 15

M

Menu Off Timer ----- 15
Menu Position ----- 15

O

Off timer ----- 15, 17
Others ----- 19

P

Package Contents ----- 9
Phase ----- 15, 19, 36
Pin Assignment ----- i
Position ----- 15, 20
Power consumption ----- 33
Power Indicator ----- 10, 17, 26
PowerManager ----- 15, 26
Power-save Setup ----- 26
PRECAUTIONS ----- 4
Preset Timing Chart ----- i

R

Range Adjustment ----- 15, 21, 24
Reset ----- 15
Resolution ----- 9, 11, 15, 24, 33, 36

S

Saturation ----- 15, 25
Save ----- 15, 24
Screen ----- 15, 19
Screen Adjustment ----- 18
Screen Size ----- 15, 22
ScreenManager ----- 15, 26
ScreenManager Adjustments
and Settings ----- 15
Security Lock Slot ----- 10
Smoothing ----- 15, 24
SPECIFICATIONS ----- 33

T

Temperature ----- 15, 24, 36
TMDS ----- 9, 36
Translucent ----- 15
TROUBLE SHOOTING ----- 29

V

VESA DPMS ----- 15, 26, 36

MEMO

APPENDIX / ANHANG / ANNEXE

Pin Assignment Pin-Belegung Affectation des Broches

* DVI-I Connector

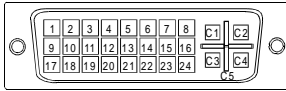

Pin No.	Signal	Pin No.	Signal	Pin No.	Signal
1	TMDS Data2-	11	TMDS Data1/3 Shield	21	NC
2	TMDS Data2+	12	NC	22	TMDS Clock Shield
3	TMDS Data2/4 Shield	13	NC	23	TMDS Clock+
4	NC*	14	+5V Power	24	TMDS Clock-
5	NC	15	Ground (return for +5V, Hsync and Vsync)	C1	Analog Red
6	DDC Clock (SCL)	16	Hot Plug Detect	C2	Analog Green
7	DDC Data (SDA)	17	TMDS Data0-	C3	Analog Blue
8	Analog Vertical Sync	18	TMDS Data0+	C4	Analog Horizontal Sync
9	TMDS Data1-	19	TMDS Data0/5 Shield	C5	Analog Ground (analog R,G,&B return)
10	TMDS Data1+	20	NC		

(*NC: No Connection)

Preset Timing Chart for Analog input Timing-Übersichten für Analog Eingang Synchronisation des Signaux pour Analog numerique

Based on the signal diagram shown below 21 factory presets have been registered in the monitor's microprocessor.

Der integrierte Mikroprozessor des Monitors unterstützt 21 werkseitige Standardeinstellungen (siehe hierzu die nachfolgenden Diagramme).

21 signaux ont été enregistrés en usine dans le microprocesseur du moniteur, conformément au diagramme de synchronisation ci-dessous.

A	Front Porch	Vordere Schwarzschulter	Front avant
B	Sync Period	Synchronimpuls	Délai de synchronisation
C	Back Porch	Hintere Schwarzschulter	Front arrière
D	Blanking Period	Austastzeit	Délai de clignotement
E	Display period	Display-Zeit	Délai d'affichage
F	Total cycle	Kompletter Zyklus	Cycle total
H	Sync signal level	Sync-Signalpegel	Niveau du signal de synchronisation
V	Video signal level	Video-Signalpegel	Niveau du signal vidéo

Mode	Dot Clock MHz	Frequencies		A: Front Porch		B: Sync Period	
		H kHz	V Hz	H µs/ Dot	V ms/ Line	H µs/ Dot	V ms/ Line
VGA 640 x 480	25.175	31.468	59.941	0.636/ 16	0.318/ 10	3.813/ 96	0.054/ 2
VGA 720 x 400	28.322	31.468	70.087	0.636/ 18	0.381/ 12	3.813/ 108	0.064/ 2
Macintosh 640 x 480	30.24	35.00	66.67	2.116/ 64	0.086/ 3	2.116/ 64	0.086/ 3
Macintosh 832 x 624	57.28	49.73	74.55	0.559/ 32	0.020/ 1	1.117/ 64	0.060/ 3
Macintosh 1152 x 870	100.0	68.68	75.06	0.320/ 32	0.044/ 3	1.280/ 128	0.044/ 3
Macintosh 1280 x 960	126.2	74.763	74.763	0.190/ 24	0.013/ 1	1.204/ 152	0.040/ 3
VESA 640 x 480	31.5	37.86	72.81	0.508/ 24	0.026/ 9	1.270/ 40	0.079/ 3
VESA 640 x 480	31.5	37.5	75.00	0.508/ 16	0.027/ 1	2.032/ 67	0.080/ 3
VESA 640 x 480	36.0	43.27	85.01	1.556/ 56	0.023/ 1	1.556/ 56	0.069/ 3
VESA 800 x 600	36.0	35.16	56.25	0.667/ 24	0.028/ 1	2.000/ 72	0.057/ 2
VESA 800 x 600	40.0	37.88	60.32	1.000/ 40	0.026/ 1	3.200/ 128	0.106/ 4
VESA 800 x 600	50.0	48.08	72.19	1.120/ 56	0.770/ 37	2.400/ 120	0.125/ 6
VESA 800 x 600	49.5	46.88	75.00	0.323/ 16	0.021/ 1	1.616/ 80	0.064/ 3
VESA 800 x 600	56.25	53.674	85.061	0.569/ 32	0.019/ 1	1.138/ 64	0.056/ 3
VESA 1024 x 768	65.0	48.36	60.00	0.369/ 24	0.062/ 3	2.092/ 136	0.124/ 6
VESA 1024 x 768	75.0	56.48	70.07	0.320/ 24	0.053/ 3	1.813/ 136	0.106/ 6
VESA 1024 x 768	78.75	60.02	75.03	0.203/ 16	0.017/ 1	1.219/ 96	0.050/ 3
VESA 1024 x 768	94.5	68.68	85.0	0.508/ 48	0.015/ 1	1.016/ 96	0.044/ 3
VESA 1152 x 864	108.0	67.50	75.00	0.593/ 64	0.015/ 1	1.185/ 128	0.044/ 3
VESA 1280 x 1024	108.0	63.98	60.02	0.444/ 48	0.016/ 1	1.037/ 112	0.047/ 3
VESA 1280 x 1024	135.0	79.97	75.02	0.119/ 16	0.013/ 1	1.067/ 144	0.038/ 3

C: Back Porch		D: Blanking Period		E: Display Period		F: Total Cycle	
H μs/ Dot	V ms/ Line	H μs/ Dot	V ms/ Line	H μs/ Dot	V ms/ Line	H μs/ Dot	V ms/ Line
1.907/ 48	1.048/ 33	6.356/ 160	1.430/ 45	25.442/ 640	15.254/ 480	31.778/ 800	16.683/ 525
1.907/ 54	1.111/ 35	6.356/ 180	1.556/ 49	25.422/ 720	12.712/ 400	31.778/ 900	14.267/ 449
3.175/ 96	1.114/ 39	7.407/ 224	1.286/ 45	21.164/ 640	13.714/ 480	28.571/ 864	15.000/ 525
3.911/ 224	0.784/ 39	5.586/ 320	0.865/ 43	14.524/ 832	12.549/ 624	20.111/ 1152	13.414/ 667
1.440/ 144	0.568/ 39	3.040/ 304	0.655/ 45	11.250/ 1152	12.667/ 870	14.560/ 1456	13.322/ 915
1.838/ 232	0.482/ 36	3.233/ 408	0.535/ 40	10.143/ 1280	12.841/ 960	13.376/ 1688	13.376/ 1000
3.810/ 128	0.528/ 28	5.587/ 192	0.634/ 40	20.317/ 640	12.678/ 480	26.413/ 832	13.735/ 520
3.810/ 120	0.427/ 16	6.349/ 200	0.533/ 20	20.317/ 640	12.800/ 480	26.667/ 840	13.333/ 500
2.222/ 80	0.578/ 25	5.333/ 192	0.670/ 29	17.778/ 640	11.093/ 480	23.111/ 832	11.764/ 509
3.556/ 128	0.626/ 22	6.222/ 224	0.711/ 25	22.222/ 800	17.067/ 600	28.444/ 1024	17.778/ 625
2.200/ 88	0.607/ 23	6.400/ 256	0.739/ 28	20.000/ 800	15.840/ 600	26.400/ 1056	16.579/ 628
1.280/ 64	0.478/ 23	4.800/ 240	1.373/ 66	16.000/ 800	12.480/ 600	20.800/ 1040	13.853/ 666
3.232/ 160	0.448/ 21	5.172/ 256	0.533/ 25	16.162/ 800	12.800/ 600	21.333/ 1056	13.333/ 625
2.702/ 152	0.503/ 27	4.409/ 248	0.578/ 31	14.222/ 800	11.179/ 600	18.631/ 1048	11.756/ 631
2.462/ 160	0.600/ 29	4.923/ 320	0.786/ 38	15.754/ 1024	15.880/ 768	20.677/ 1344	16.666/ 806
19.20/ 144	0.513/ 29	4.053/ 304	0.673/ 38	13.653/ 1024	16.599/ 768	17.707/ 1328	14.272/ 806
2.235/ 176	0.466/ 28	3.657/ 288	0.533/ 32	13.003/ 1024	12.795/ 768	16.660/ 1312	13.328/ 800
2.201/ 208	0.524/ 36	3.725/ 352	0.582/ 40	10.836/ 1024	11.183/ 768	14.561/ 1376	11.765/ 808
2.370/ 256	0.474/ 32	4.148/ 448	0.553/ 36	10.667/ 1152	12.800/ 864	14.815/ 1600	13.333/ 900
2.296/ 248	0.594/ 38	3.778/ 408	0.656/ 42	11.852/ 1280	16.005/ 1024	15.630/ 1688	16.661/ 1066
1.837/ 248	0.475/ 38	3.022/ 408	0.525/ 42	9.481/ 1280	12.804/ 1024	12.504/ 1688	13.329/ 1066

MEMO

[Applicable to gray (standard color version only).]



Congratulations!

You have just purchased a TCO'99 approved and labelled product! Your choice has provided you with a product developed for professional use. Your purchase has also contributed to reducing the burden on the environment and also to the further development of environmentally adapted electronics products.

Why do we have environmentally labelled computers?

In many countries, environmental labelling has become an established method for encouraging the adaptation of goods and services to the environment. The main problem, as far as computers and other electronics equipment are concerned, is that environmentally harmful substances are used both in the products and during their manufacture. Since it is not so far possible to satisfactorily recycle the majority of electronics equipment, most of these potentially damaging substances sooner or later enter nature.

There are also other characteristics of a computer, such as energy consumption levels, that are important from the viewpoints of both the work (internal) and natural (external) environments. Since all methods of electricity generation have a negative effect on the environment (e.g. acidic and climate-influencing emissions, radioactive waste), it is vital to save energy. Electronics equipment in offices is often left running continuously and thereby consumes a lot of energy.

What does labelling involve?

This product meets the requirements for the TCO'99 scheme which provides for international and environmental labelling of personal computers. The labelling scheme was developed as a joint effort by the TCO (The Swedish Confederation of Professional Employees), Svenska Naturskyddsforeningen (The Swedish Society for Nature Conservation) and Statens Energimyndighet (The Swedish National Energy Administration).

Approval requirements cover a wide range of issues: environment, ergonomics, usability, emission of electric and magnetic fields, energy consumption and electrical and fire safety.

The environmental demands impose restrictions on the presence and use of heavy metals, brominated and chlorinated flame retardants, CFCs (freons) and chlorinated solvents, among other things. The product must be prepared for recycling and the manufacturer is obliged to have an environmental policy which must be adhered to in each country where the company implements its operational policy.

The energy requirements include a demand that the computer and/or display, after a certain period of inactivity, shall reduce its power consumption to a lower level in one or more stages. The length of time to reactivate the computer shall be reasonable for the user.

Labelled products must meet strict environmental demands, for example, in respect of the reduction of electric and magnetic fields, physical and visual ergonomics and good usability.

Below you will find a brief summary of the environmental requirements met by this product.

The complete environmental criteria document may be ordered from:

TCO Development

SE-114 94 Stockholm, Sweden

Fax: +46 8 782 92 07

Email (Internet): development@tco.se

Current information regarding TCO'99 approved and labelled products may also be obtained via the Internet, using the address: <http://www.tco-info.com/>

[Applicable to gray (standard color version only).]

Environmental requirements

Flame retardants

Flame retardants are present in printed circuit boards, cables, wires, casings and housings. Their purpose is to prevent, or at least to delay the spread of fire. Up to 30% of the plastic in a computer casing can consist of flame retardant substances. Most flame retardants contain bromine or chloride, and those flame retardants are chemically related to another group of environmental toxins, PCBs. Both the flame retardants containing bromine or chloride and the PCBs are suspected of giving rise to severe health effects, including reproductive damage in fish-eating birds and mammals, due to the bio-accumulative* processes. Flame retardants have been found in human blood and researchers fear that disturbances in foetus development may occur.

The relevant TCO'99 demand requires that plastic components weighing more than 25 grams must not contain flame retardants with organically bound bromine or chlorine. Flame retardants are allowed in the printed circuit boards since no substitutes are available.

Cadmium**

Cadmium is present in rechargeable batteries and in the colour-generating layers of certain computer displays. Cadmium damages the nervous system and is toxic in high doses. The relevant TCO'99 requirement states that batteries, the colour-generating layers of display screens and the electrical or electronics components must not contain any cadmium.

Mercury**

Mercury is sometimes found in batteries, relays and switches. It damages the nervous system and is toxic in high doses. The relevant TCO'99 requirement states that batteries may not contain any mercury. It also demands that mercury is not present in any of the electrical or electronics components associated with the labelled unit.

CFCs (freons)

The relevant TCO'99 requirement states that neither CFCs nor HCFCs may be used during the manufacture and assembly of the product. CFCs (freons) are sometimes used for washing printed circuit boards. CFCs break down ozone and thereby damage the ozone layer in the stratosphere, causing increased reception on earth of ultraviolet light with e.g. increased risks of skin cancer (malignant melanoma) as a consequence.

Lead**

Lead can be found in picture tubes, display screens, solders and capacitors. Lead damages the nervous system and in higher doses, causes lead poisoning. The relevant TCO'99 requirement permits the inclusion of lead since no replacement has yet been developed.

* Bio-accumulative is defined as substances which accumulate within living organisms.

** Lead, Cadmium and Mercury are heavy metals which are Bio-accumulative.

For U.S.A, Canada, etc. (rated 100-120 Vac) Only

FCC Declaration of Conformity

We, the Responsible Party EIZO NANAOTECHNOLOGIES INC.
5710 Warland Drive, Cypress, CA 90630
Phone: 562 431 5011

declare that the product Trade name: EIZO
Model: FlexScan L461

is in conformity with Part 15 of the FCC Rules. Operation of this product is subject to the following two conditions: (1) this device may not cause harmful interference, and (2) this device must accept any interference received, including interference that may cause undesired operation.

This equipment has been tested and found to comply with the limits for a Class B digital device, pursuant to Part 15 of the FCC Rules. These limits are designed to provide reasonable protection against harmful interference in a residential installation. This equipment generates, uses, and can radiate radio frequency energy and, if not installed and used in accordance with the instructions, may cause harmful interference to radio communications. However, there is no guarantee that interference will not occur in a particular installation. If this equipment does cause harmful interference to radio or television reception, which can be determined by turning the equipment off and on, the user is encouraged to try to correct the interference by one or more of the following measures.

- *Reorient or relocate the receiving antenna.
- *Increase the separation between the equipment and receiver.
- *Connect the equipment into an outlet on a circuit different from that to which the receiver is connected.
- *Consult the dealer or an experienced radio/TV technician for help.

Changes or modifications not expressly approved by the party responsible for compliance could void the user's authority to operate the equipment.

Note

Use the attached specified cable below or EIZO signal cable with this monitor so as to keep interference within the limits of a Class B digital device.

- AC Cord
- Shielded Signal Cable (enclosed)

Canadian Notice

This Class B digital apparatus complies with Canadian ICES-003.

Cet appareil numérique de la classe B est conforme à la norme NMB-003 du Canada.