

# User's Manual Bedienungsanleitung Manuel d'utilisation

## RadiForce® R12

Color LCD Monitor  
LCD-Farbmonitor  
Moniteur couleur LCD

### **Important**

Please read this User's Manual carefully to familiarize yourself with safe and effective usage procedures. Please retain this manual for future reference.

### **Wichtig**

Bitte lesen Sie diese Bedienungsanleitung sorgfältig durch, um sich mit dem sicheren und rationellen Betrieb dieses Produkts vertraut zu machen. Bewahren Sie das vorliegende Handbuch zu Referenzzwecken auf.

### **Important**

Veuillez lire attentivement ce manuel d'utilisation pour utiliser pleinement votre appareil en toute sécurité. Veuillez conserver ce manuel pour référence ultérieure.



For U.S.A, Canada, etc. (rated 100-120 Vac) Only

---

## FCC Declaration of Conformity

We, the Responsible Party

EIZO NANA O TECHNOLOGIES INC.  
5710 Warland Drive, Cypress, CA 90630  
Phone: (562) 431-5011

declare that the product

Trade name: EIZO  
Model: RadiForce R12

is in conformity with Part 15 of the FCC Rules. Operation of this product is subject to the following two conditions: (1) this device may not cause harmful interference, and (2) this device must accept any interference received, including interference that may cause undesired operation.

This equipment has been tested and found to comply with the limits for a Class B digital device, pursuant to Part 15 of the FCC Rules. These limits are designed to provide reasonable protection against harmful interference in a residential installation. This equipment generates, uses, and can radiate radio frequency energy and, if not installed and used in accordance with the instructions, may cause harmful interference to radio communications. However, there is no guarantee that interference will not occur in a particular installation. If this equipment does cause harmful interference to radio or television reception, which can be determined by turning the equipment off and on, the user is encouraged to try to correct the interference by one or more of the following measures.

- \* Reorient or relocate the receiving antenna.
- \* Increase the separation between the equipment and receiver.
- \* Connect the equipment into an outlet on a circuit different from that to which the receiver is connected.
- \* Consult the dealer or an experienced radio/TV technician for help.

Changes or modifications not expressly approved by the party responsible for compliance could void the user's authority to operate the equipment.

### Note

Use the attached specified cable below or EIZO signal cable with this monitor so as to keep interference within the limits of a Class B digital device.

- AC Cord
- Shielded Signal Cable (enclosed)

---

## Canadian Notice

This Class B digital apparatus complies with Canadian ICES-003.

Cet appareil numérique de la classe B est conforme à la norme NMB-003 du Canada.

# User's Manual

# RadiForce® R12

Color LCD Monitor

It shall be assured that the final system is in compliance to IEC60601-1-1 requirements.

## SAFETY SYMBOLS

This manual uses the safety symbols below. They denote critical information. Please read them carefully.



### WARNING

Failure to abide by the information in a WARNING may result in serious injury and can be life threatening.



### CAUTION

Failure to abide by the information in a CAUTION may result in moderate injury and/or property or product damage.



Indicates a prohibited action.



Indicates to ground for safety.

- Power supplied equipment can emit electromagnetic waves, that could influence, limit or result in malfunction of the monitor. Install the equipment in a controlled environment, where such effects are avoided.
- This is a monitor intended for use in a medical setting.

---

Copyright© 2004-2010 EIZO NANA O CORPORATION All rights reserved. No part of this manual may be reproduced, stored in a retrieval system, or transmitted, in any form or by any means, electronic, mechanical, or otherwise, without the prior written permission of EIZO NANA O CORPORATION.

EIZO NANA O CORPORATION is under no obligation to hold any submitted material or information confidential unless prior arrangements are made pursuant to EIZO NANA O CORPORATION's receipt of said information. Although every effort has been made to ensure that this manual provides up-to-date information, please note that EIZO monitor specifications are subject to change without notice.

---

Apple and Macintosh are registered trademarks of Apple Computer, Inc.

VGA is a registered trademark of International Business Machines Corporation.

VESA is a registered trademark or a trademark of Video Electronics Standards Association in the United States and other countries.

Windows is a registered trademark of Microsoft Corporation in the United States and other countries.

PowerManager is a trademark of EIZO NANA O CORPORATION.

EIZO, EIZO Logo, RadiCS, RadiForce, RadiNET and ScreenManager are registered trademarks of EIZO NANA O CORPORATION in Japan and other countries.

All other trademarks are the properties of their respective owners.

---

# TABLE OF CONTENTS

 <b>PRECAUTIONS</b> .....	<b>4</b>
<b>1. INTRODUCTION</b> .....	<b>9</b>
1-1. Features .....	9
1-2. Package Contents.....	9
1-3. Controls & Connectors .....	10
<b>2. CABLE CONNECTION</b> .....	<b>12</b>
2-1. Before Connecting .....	12
2-2. Connecting the signal cable (For the computer employing D-Sub or DVI connector) .....	13
2-3. Connecting the signal cable (For the computer employing ADC) .....	16
2-4. Connecting Two PCs to the Monitor.....	19
<b>3. ScreenManager</b> .....	<b>21</b>
3-1. How to use the ScreenManager .....	21
3-2. ScreenManager Adjustments and Settings.....	22
3-3. FineContrast .....	23
3-4. Useful Functions .....	24
<b>4. ADJUSTMENT</b> .....	<b>26</b>
4-1. Screen Adjustment .....	26
4-2. Displaying Low Resolutions .....	30
4-3. Color Adjustment .....	32
4-4. Power-save Setup .....	35
<b>5. MAKING USE OF USB (Universal Serial Bus)</b> .....	<b>36</b>
<b>6. ATTACHING AN ARM</b> .....	<b>38</b>
<b>7. TROUBLESHOOTING</b> .....	<b>40</b>
<b>8. CLEANING</b> .....	<b>44</b>
<b>9. SPECIFICATIONS</b> .....	<b>45</b>
<b>10. GLOSSARY</b> .....	<b>48</b>
<b>APPENDIX/ANHANG/ANNEXE</b> .....	<b>i</b>

# PRECAUTIONS



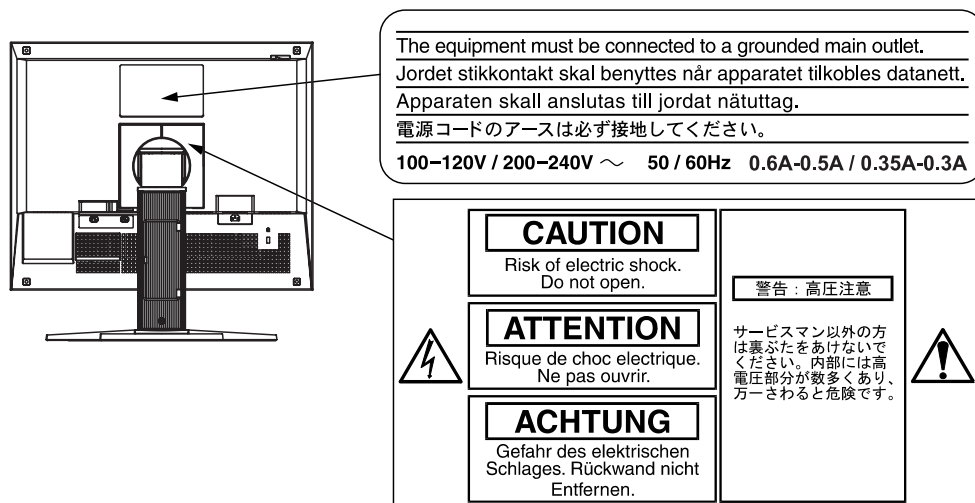

## IMPORTANT!

- This product has been adjusted specifically for use in the region to which it was originally shipped. If operated outside the region to which it was originally shipped, the product may not perform as stated in the specifications.
- To ensure personal safety and proper maintenance, please read this section and the caution statements on the unit (refer to the figure below).

### [Location of the Caution Statements]



### [Symbols on the unit]

Symbol	Location	This symbol indicates
	Top	Main power switch Press to turn the monitor's main power off.
	Top	Main power switch Press to turn the monitor's main power on.
	Front Control panel	Power button Press to turn the monitor's power on or off.
	Rear Name Plate	Alternating current
	Rear	Alerting electrical hazard
	Rear	Caution Refer to SAFETY SYMBOLS section in this manual.

## **WARNING**

**If the unit begins to emit smoke, smells like something is burning, or makes strange noises, disconnect all power connections immediately and contact your dealer for advice.**

Attempting to use a malfunctioning unit may result in fire, electric shock, or equipment damage.

### **Do not open the cabinet or modify the unit.**

Opening the cabinet or modifying the unit may result in fire, electric shock, or burn.



### **Refer all servicing to qualified service personnel.**

Do not attempt to service this product yourself as opening or removing covers may result in fire, electric shock, or equipment damage.

### **Keep small objects or liquids away from the unit.**

Small objects accidentally falling through the ventilation slots into the cabinet or spillage into the cabinet may result in fire, electric shock, or equipment damage.

If an object or liquid falls/spills into the cabinet, unplug the unit immediately. Have the unit checked by a qualified service engineer before using it again.

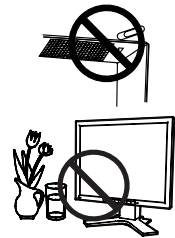

### **Place the unit at the strong and stable place.**

A unit placed on an inadequate surface may fall and result in injury or equipment damage.

If the unit falls, disconnect the power immediately and ask your dealer for advice. Do not continue using a damaged unit. Using a damaged unit may result in fire or electric shock.



### **Set the unit in an appropriate location.**

Not doing so may result in fire, electric shock, or equipment damage.

- \* Do not place outdoors.
- \* Do not place in the transportation system (ship, aircraft, trains, automobiles, etc.)
- \* Do not place in a dusty or humid environment.
- \* Do not place in a location where the steam comes directly on the screen.
- \* Do not place near heat generating devices or a humidifier.
- \* Do not place in an inflammable gas environment.

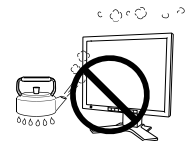

**To avoid danger of suffocation, keep the plastic packing bags away from babies and children.**

**Use the enclosed power cord and connect to the standard power outlet of your country.**

Be sure to remain within the rated voltage of the power cord.

Not doing so may result in fire or electric shock.

## **WARNING**

---

### **To disconnect the power cord, grasp the plug firmly and pull.**

Tugging on the cord may damage and result in fire or electric shock.

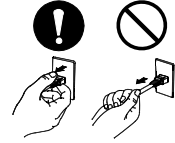

---

### **The equipment must be connected to a grounded main outlet.**

Not doing so may result in fire or electric shock.



---

### **Use the correct voltage.**

- \* The unit is designed for use with a specific voltage only. Connection to another voltage than specified in this User's Manual may cause fire, electric shock, or equipment damage.
- \* Do not overload your power circuit, as this may result in fire or electric shock.

---

### **Handle the power cord with care.**

- \* Do not place the cord underneath the unit or other heavy objects.
- \* Do not pull on or tie the cord.

If the power cord becomes damaged, stop using it. Use of a damaged cord may result in fire or electric shock.



---

### **Never touch the plug and power cord if it begins to thunder.**

Touching them may result in electric shock.



---

### **When attaching an arm stand, please refer to the user's manual of the arm stand and install the unit securely with the enclosed screws.**

Not doing so may cause the unit to come unattached, which may result in injury or equipment damage. When the unit is dropped, please ask your dealer for advice. Do not continue using a damaged unit. Using a damaged unit may result in fire or electric shock. When reattaching the tilt stand, please use the same screws and tighten them securely.

---



## WARNING

### **Do not touch a damaged LCD panel directly with bare hands.**

The liquid crystal which leaks from the panel is poisonous if it enters the eyes or mouth.

If any part of the skin or body comes in direct contact with the panel, please wash thoroughly. If some physical symptoms result, please consult your doctor.



### **Follow local regulation or laws for safe disposal.**

The backlight of the LCD panel contains mercury.

## CAUTION

### **Handle with care when carrying the unit.**

Disconnect the power cord and cables when moving the unit. Moving the unit with the cord attached is dangerous. It may result in injury.

### **When handling the unit, grip the bottom of the unit firmly with both hands ensuring the panel faces outward before lifting.**

Dropping the unit may result in injury or equipment damage.

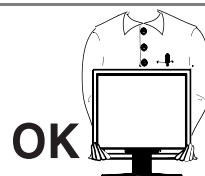

### **Do not block the ventilation slots on the cabinet.**

- \* Do not place any objects on the ventilation slots.
- \* Do not install the unit in a closed space.
- \* Do not use the unit laid down or upside down.

Blocking the ventilation slots prevents proper airflow and may result in fire, electric shock, or equipment damage.



### **Do not touch the plug with wet hands.**

Doing so may result in electrical shock.



### **Use an easily accessible power outlet.**

This will ensure that you can disconnect the power quickly in case of a problem.

### **Periodically clean the area around the plug.**

Dust, water, or oil on the plug may result in fire.

### **Unplug the unit before cleaning it.**

Cleaning the unit while it is plugged into a power outlet may result in electric shock.

**If you plan to leave the unit unused for an extended period, disconnect the power cord from the wall socket after turning off the power switch for the safety and the power conservation.**

## LCD Panel

---

---

In order to suppress the luminosity change by long-term use and to maintain the stable luminosity, please use the monitor with the brightness below 160 cd/m<sup>2</sup> (BRIGHTNESS approximately 70 %).

---

The screen may have defective pixels. These pixels may appear as slightly light or dark area on the screen. This is due to the characteristics of the panel itself, and not the product.

---

The backlight of the LCD panel has a fixed life span. When the screen becomes dark or begins to flicker, please contact your dealer.

---

Do not press on the panel or edge of the frame strongly, as this may result in damage to the screen. There will be prints left on the screen if the pressed image is dark or black. If pressure is repeatedly applied to the screen, it may deteriorate or damage your LCD panel. Leave the screen white to decrease the prints.

---

Do not scratch or press on the panel with any sharp objects, such as a pencil or pen as this may result in damage to the panel. Do not attempt to brush with tissues as this may scratch the LCD panel.

---

When the screen image is changed after displaying the same image for extended periods of time, an afterimage may appear. Use the screen saver or timer to avoid displaying the same image for extended periods of time.

---

# 1. INTRODUCTION

Thank you very much for choosing an EIZO Color Monitor.

## 1-1. Features

- Dual inputs compliant (DVI-I connector x 2)
- DVI (p. 48) Digital input (TMDS (p. 49)) compliant
- [Horizontal scanning frequency] Analog: 30 - 82 kHz  
Digital: 30 - 65 kHz
- [Vertical scanning frequency] Analog: 49 - 86 Hz (1280 x 1024: 49 - 75 Hz)  
Digital: 59 - 61 Hz (VGA text: 69 - 71 Hz)
- [Resolution] 1M pixels (1280 dots x 1024 lines)
- [Frame synchronous mode] 57.5 - 67 Hz supported  
\* Only if the [Full Screen] is selected from the <Screen Size>.
- Smoothing function incorporated for the adjustment of an enlarged image (p.30)
- FineContrast modes, to select the most suitable mode for screen display (p.23)
- Selectable DICOM (p.48) Part 14 complied screen (FineContrast modes, p.23)
- The utility software “ToneCurve Tuning Utility” (for Windows), which can adjust the tone setting of the monitor from the computer, is included (refer to the ToneCurve Tuning Utility Disk).
- The utility software “ScreenManager Pro for LCD” (for Windows) which can control the monitor from a PC with a mouse or keyboard, is included (refer to the EIZO LCD Utility Disk).
- The height adjustable stand incorporated
- Ultra slim bezel incorporated
- The Portrait display (1024 dots x 1280 lines) capability

## 1-2. Package Contents

Please contact your local dealer for assistance if any of the listed items are missing or damaged.

- LCD Monitor
- Power Cord
- Signal Cable (FD-C16)
- Signal Cable (FD-C35/FD-C39)
- EIZO USB Cable (MD-C93)
- ToneCurve Tuning Utility Disk
- EIZO LCD Utility Disk
- User's Manual
- ScreenManager Quick Reference
- LIMITED WARRANTY

### NOTE

- Please retain the packing materials for future transference.

# 1-3. Controls & Connectors

## Front

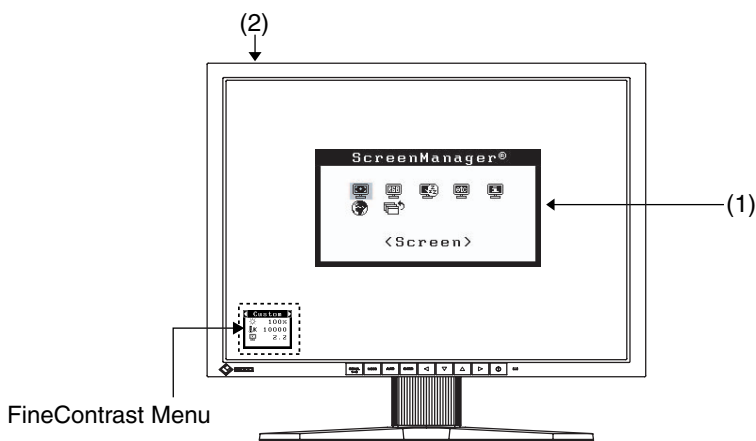

### Control Panel

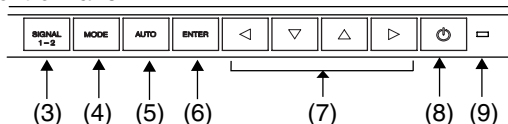

- (1) ScreenManager® Main Menu
- (2) I/O Main Power Switch
- (3) SIGNAL1-2 Input Signal Selection Button
- (4) MODE Mode Button<sup>1</sup>
- (5) AUTO Auto Adjustment Button
- (6) ENTER Enter Button
- (7) ◀◻▶▶ Control Buttons (Left, Down, Up, Right)<sup>2</sup>
- (8) ⏻ Power Button
- (9) ◻ Power Indicator<sup>3</sup>

Blue	Operation
Yellow / Flashing yellow (2 times for each)	Power saving
Flashing yellow slowly	Power is off (Main power is on)
Off	Power off

<sup>1</sup> Pushing the Mode button once allows you to display a FineContrast menu. Pushing the Mode button more than once allows you to select a FineContrast mode. (The ScreenManager Main Menu and the FineContrast Menu cannot be displayed at the same time.)(see page 23. )

<sup>2</sup> These buttons are changed to Up, Left, Right, Down in case of selecting “Portrait” for <Orientation> of ScreenManager <Others> (p.22).

<sup>3</sup> Blue lighting, when the screen is displayed (Operation mode), is made to non-light, see page 22. Regarding the power indicator for the “Off Timer”, see page 24.

## Rear

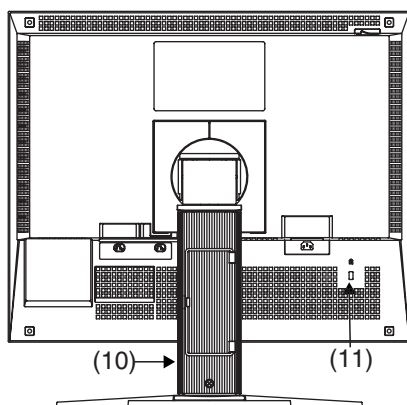

### Bottom

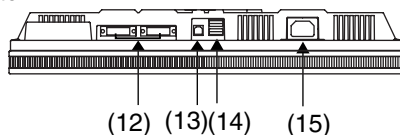

(10) Height Adjustable Stand (Detachable)<sup>4</sup>



Security Lock Slot<sup>5</sup>

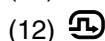

DVI-I Input Connector x 2 (SIGNAL 1, SIGNAL 2)

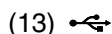

USB Upstream Port (x 1)

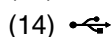

USB Downstream Ports (x 2)

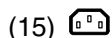

Power Connector

<sup>4</sup> The LCD monitor has the capability of the Portrait/Landscape display. (The panel pivots in the clockwise direction 90°.) For the Portrait display, use the software for the portrait.

The LCD monitor can be used with an optional arm stand by removing the stand. (see page 38)

<sup>5</sup> Allows for connection of a security cable. This lock supports Kensington's MicroSaver security system. For further information, please consult Kensington Technology Group  
2855 Campus Drive, San Mateo, CA 94403 USA  
Tel.: 800-650-4242, x3348, Intl: 650-572-2700, x3348  
Fax: 650-572-9675  
<http://www.kensington.com>

## 2. CABLE CONNECTION

### 2-1. Before Connecting

Before connecting your monitor to the PC, change the display screen settings (resolution p. 49) and frequency) in accordance with the charts below.

#### NOTE

- When your computer and display support VESA DDC, the suitable resolution and the refresh rate are set by just plugging your display into the computer without any manual settings.

#### Analog Input

Resolution	Frequency	Dot Clock	Remarks
640 × 480	~ 85 Hz	135 MHz (Max.)	VGA, VESA
640 × 480	67 Hz		Apple Macintosh
720 × 400	70 Hz		VGA TEXT
720 × 480	60 Hz		VESA
800 × 600	~ 85 Hz		VESA
832 × 624	75 Hz		Apple Macintosh
1024 × 768	~ 85 Hz		VESA
1152 × 864	75 Hz		VESA
1152 × 870	75 Hz		Apple Macintosh
1152 × 900	~ 76 Hz		SUN WS
1280 × 960	60 Hz		VESA
1280 × 960	75 Hz		Apple Macintosh
1280 × 1024	67 Hz		SUN WS
1280 × 1024	~ 75 Hz		VESA

#### Digital Input

Only the following resolutions with frequency can be displayed on this model.

Resolution	Frequency	Dot Clock	Remarks
640 × 480	60Hz	108 MHz (Max.)	VGA
720 × 400	70Hz		VGA TEXT
800 × 600	60Hz		VESA
1024 × 768	60Hz		VESA
1280 × 1024	60Hz		VESA

## 2-2. Connecting the signal cable (For the computer employing D-Sub or DVI connector)

### NOTE

- Be sure that the power switches of both the PC and the monitor are OFF.

1. Plug the signal cable into the connector at the rear of the monitor and the other end of the cable into the video connector on the PC.

After connecting, secure the connection with the screw-in fasteners.

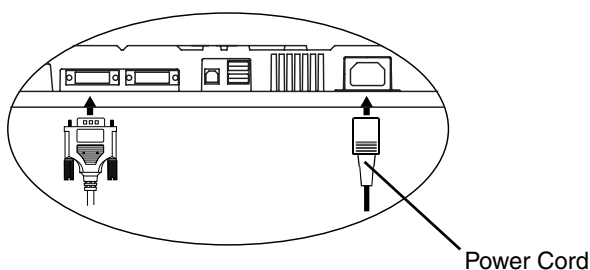

### Analog Input

Signal Cable	Connector	PC
Signal Cable (FD-C16 enclosed) 	Video Output Connector / D-Sub mini 15 pin Input Connector (monitor) / DVI	<ul style="list-style-type: none"> <li>• Standard graphics card</li> <li>• Power Macintosh G3 (Blue &amp; White) / Power Mac G4 (VGA)</li> </ul>
Signal Cable (FD-C16 enclosed) + Adapter* 	Video Output Connector / D-Sub 15 pin Input Connector (monitor) / DVI	<ul style="list-style-type: none"> <li>• Macintosh</li> <li>*Macintosh Adapter (Optional)</li> </ul>

## Digital Input

Signal Cable	Connector	PC
Signal Cable (FD-C35/FD-C39 enclosed) 	Video Output Connector / DVI Input Connector (monitor) / DVI	<ul style="list-style-type: none"> <li>• Digital graphics board</li> <li>• Power Mac G4 / G5 (DVI)</li> </ul>

**2.** Plug the power cord into the power connector on the rear of the monitor.

**3.** Lead the power cord and signal cable into the cable holder at rear of the monitor.

### NOTE

- The cables are recommended to lead with slight sag for the smooth motion of the stand and the Portrait/Landscape display.

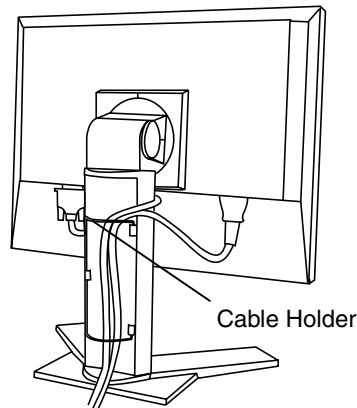

**4.** Plug the other end of the power cord into a power outlet.

The monitor's power indicator will flash yellow slowly.



### WARNING

**Use the enclosed power cord and connect to the standard power outlet of your country.**

Be sure to remain within the rated voltage of the power cord.

Not doing so may result in fire or electric shock.



---

**⚠ WARNING**

**The equipment must be connected to a grounded main outlet.**

Not doing so may result in fire or electric shock. Not doing so may result in fire or electric shock.



---

**5. Turn on the monitor's Power Button and then switch on the PC's power.**

The monitor's power indicator will light up (blue).

If an image does not appear, refer to the "7. TROUBLESHOOTING" (p.40) for advice.

Whenever finished, turn off the PC and the monitor.

**NOTE**

- When turning on the monitor, the kind of the input signal (Signal1 or 2/Analog or Digital) is displayed for a few seconds on the right top corner of the screen.
- Adjust brightness of the screen depending on the brightness of your environment.
- Be sure to take adequate rests. A 10-minute rest period each hour is suggested.

**6. When using the software, ScreenManager Pro for LCD (for Windows), connects the upstream port of the monitor to the downstream port of the USB compliant PC or another hub with the USB cable.**

After connecting the USB cable, the USB function can be set up automatically. For further details about the "ScreenManager Pro for LCD", refer to the readme.txt in the "EIZO LCD Utility Disk" CD-ROM.

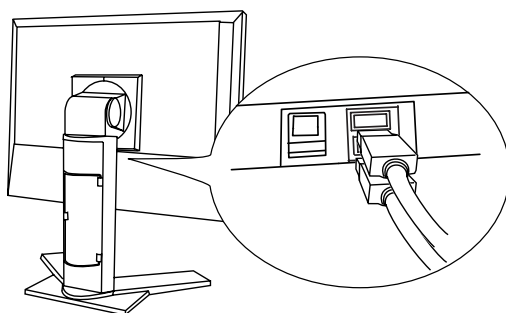

## 2-3. Connecting the signal cable (For the computer employing ADC)

### NOTE

- Be sure that the power switches of both the PC and the monitor are OFF.

### 1. Plug the signal cable into the connector at the rear of the monitor and the other end of the cable into the video connector on the PC.

After connecting, secure the connection with the screw-in fasteners.

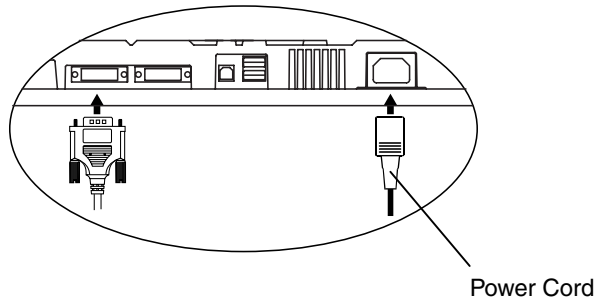

### To Input the Signal Through ADC

Signal Cable	Connector	PC
Signal Cable (FD-C35/FD-C39, enclosed) + ADC-DVI Display Adapter (Commercially available) 	Video Output Connector/ ADC Input Connector (monitor)/ DVI	• Power Mac G4 / G5 (ADC)

### NOTE

- ADC-DVI display adapter is required if the monitor connects to Power Mac G4/ G5. The adapter is commercially available.

### 2. Plug the power cord into the power connector on the rear of the monitor.

3. Lead the power cord and signal cable into the cable holder at rear of the monitor.

**NOTE**

- The cables are recommended to lead with slight sag for the smooth motion of the stand and the Portrait/Landscape display.

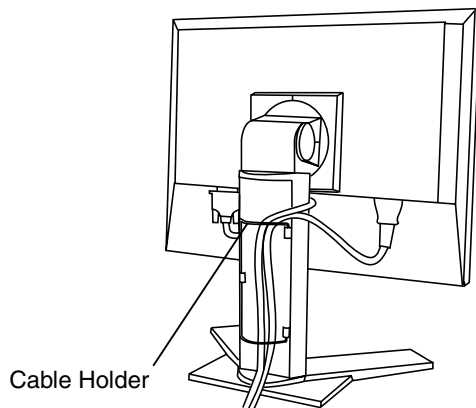

4. Plug the other end of the cord into a power outlet.

The monitor's power indicator will flash yellow slowly.

**⚠ WARNING**

---

**Use the enclosed power cord and connect to the standard power outlet of your country.**

Be sure to remain within the rated voltage of the power cord.

Not doing so may result in fire or electric shock.

---

**The equipment must be connected to a grounded main outlet.**

Not doing so may result in fire or electric shock. Not doing so may result in fire or electric shock.



## 5. Press the power button while pressing the Input Signal Selection button.

The Input Selection menu is appeared on the screen.

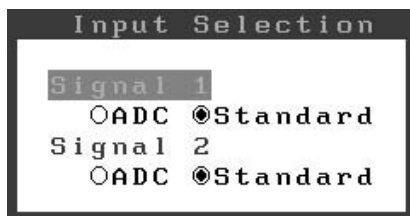
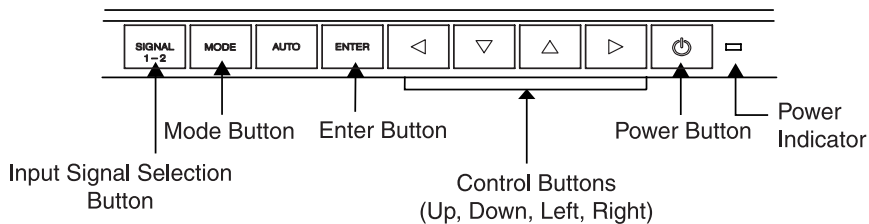

## 6. Change SIGNAL 1 (DVI-I Connector) in the Input Selection menu to “ADC”.

Press Enter button to complete the setting and the menu closes.

## 7. Switch on the PC's power.

The monitor's power indicator will light up (blue).

If an image does not appear, refer to the “7. TROUBLESHOOTING” (p.40) for additional advice.

Whenever finishing your operation, turn off the PC and the monitor.

### NOTE

- When changing the signal connector except ADC, open the Input Selection menu again and change the setting to “Standard”.

## 2-4. Connecting Two PCs to the Monitor

Two PCs can be connected to the monitor through the Signal 1 and the Signal 2 on the back of the monitor.

### Connecting Examples

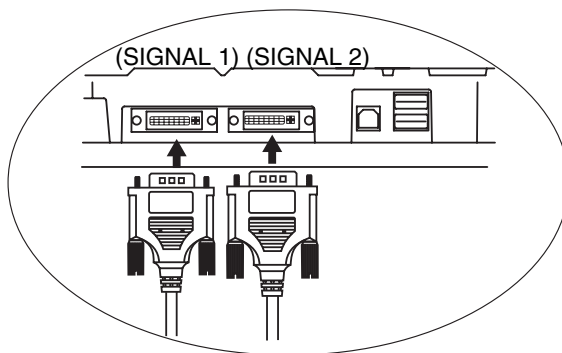

	PC 1			PC 2		
(Ex.1)	Analog	D-Sub mini 15 pin	Signal Cable (FD-C16 enclosed) 	Signal Cable (FD-C35/FD-C39 enclosed) 	DVI	Digital
(Ex.2)	Analog	D-Sub mini 15 pin	Signal Cable (FD-C16 enclosed) 	Signal Cable (FD-C16 optional) 	D-Sub mini 15 pin	Analog
(Ex.3)	Digital	DVI	Signal Cable (FD-C35/FD-C39 enclosed) 	Signal Cable (FD-C35/FD-C39 optional) 	DVI	Digital

### Selecting the Active Input

The Input Signal Selection Button on the control panel can be used to select either Signal 1 or Signal 2 as the active input at any time. Every time the button is pressed, the input changes. When switching the signal, the kind of the input signal (Signal1 or 2/Analog or Digital) is displayed for a few seconds on the right top corner of the screen.

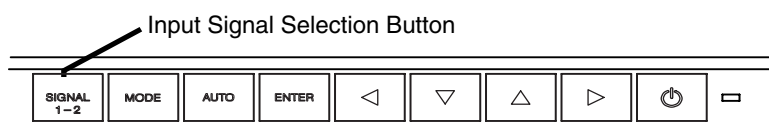

## The Priority Input Signal

This function is used to select which PC will have priority to control the monitor when utilizing two PCs. The monitor constantly checks the input signals and switches automatically in accordance with the “Input Priority” setting (see table below). Once a priority is set, whenever a change of signal is detected at the selected input, the monitor will switch the input to that signal.

In the case of only one signal being present at either input, the monitor automatically detects and displays that signal.

Priority Setting	Performance
1 (SIGNAL 1)	If signals from both inputs are present, the monitor gives preference to Signal 1 in the following cases. <ul style="list-style-type: none"> <li>• When the power of the monitor is turned ON</li> <li>• When the signal input to Signal 1 is changed even if active input was Signal 2.</li> </ul>
2 (SIGNAL 2)	If signals from both inputs are present, the monitor gives preference to Signal 2 in the following cases. <ul style="list-style-type: none"> <li>• When the power of the monitor is turned ON</li> <li>• When the signal input to Signal 2 is changed even if active input was Signal 1.</li> </ul>
Manual	The monitor will not detect signals automatically in this mode. Select the active input by pressing the Input Signal Selection Button on the monitor's control panel.

### NOTE

- When the “1” or “2” is selected, the power saving mode of the monitor activates only if both PCs are in power saving mode.

# 3. ScreenManager

## 3-1. How to use the ScreenManager

ScreenManager allows you to adjust screen performance through the main menu and select a FineContrast mode easily.

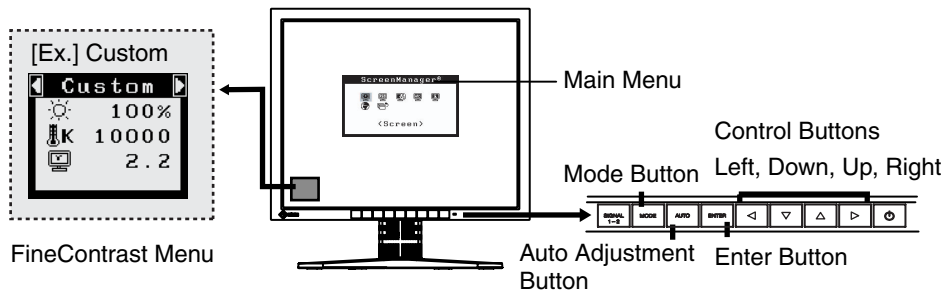

### NOTE

- Main Menu and FineContrast Menu cannot be activated at the same time.

### 1. Entering the ScreenManager

Press the Enter Button once to display the main menu of the ScreenManager.

### 2. Making Adjustments and Settings

- (1) Select the desired sub menu icon using the Control Buttons and press the Enter Button. The sub menu appears.
- (2) Use the Control Buttons to select the desired setting icon and press the Enter Button. The setting menu appears.
- (3) Use the Control Buttons to make all required adjustments and press the Enter Button to save the settings.

### 3. Exiting the ScreenManager

- (1) To return to the main menu, select the <Return> icon or press the Down Button twice, followed by the Enter Button.
- (2) To exit the ScreenManager, select the <Exit> icon or press the Down Button twice, followed by the Enter Button.

### NOTE

- Double clicking the Enter Button also exits the ScreenManager menu.

#### FineContrast Menu

Pressing the Mode button allows you to select the best suited mode for screen display from 6 FineContrast modes; Custom, sRGB, CAL, Text, DICOM-CL and DICOM-BL. To exit the menu, press the Enter Button. (p. 23)

## 3-2. ScreenManager Adjustments and Settings.

The following table shows all the ScreenManager's adjustment and setting menus.

“\*” indicates adjustments of analog input only and “\*\*\*” indicates digital input only.

Main menu	Sub menu		Reference	
Screen	Clock	*	4-1. Screen Adjustment (p.26)	
	Phase	*		
	Position	*		
	Resolution	*		
	Range Adjustment	*		
	Smoothing			
	Signal Filter	*		
Color (Custom) <sup>1</sup>	Brightness		4-3. Color Adjustment (p.32)	
	Temperature			
	Gamma			
	Saturation			
	Hue			
	Gain			
	6 Colors			
	Unlock			
Reset				
PowerManager	DVI DMPM	**	4-4. Power-save Setup (p.34)	
	VESA DPMS	*		
Others	Screen Size		4-2. Displaying Low Resolutions (p.30)	
	Border Intensity			
	Input Priority		Select the priority input signal. (p.20)	
	Off Timer		Set the monitor's off timer to on or off. (p.24)	
	Beep		Set the monitor's beeper to on or off. (p.46)	
	Menu Settings	Menu Size		Change the size of the menu.
		Menu Position		Adjust the menu position
		Menu Off Timer		Set the menu displaying time. <sup>2</sup>
		Translucent		Set the transparency of the background.
	Orientation		Change the orientation of the ScreenManager for monitor's portrait position.	
Power Indicator		Make non-light for blue lighting when the screen is displayed. (p.25)		
Reset		Return to the factory default settings. (p.46)		
Information	Information		Review the ScreenManager's settings, model name, serial number and usage time <sup>3</sup> .	
Language	English, German, French, Spanish, Italian, Swedish and Japanese		Select the ScreenManager's language.	

<sup>1</sup>The adjustable functions depend on the selected FineContrast mode. (see page 32).

<sup>2</sup>The displaying time of the FineContrast Menu cannot be changed.

<sup>3</sup>Due to the inspection on the factory, the usage time may not be “0 hour” at shipping.



## 3-3. FineContrast

This function allows you to select the best suited mode for screen display.

### To select the Mode

Pressing the Mode button allows you to select the best suited mode for screen display from 6 FineContrast modes; “Custom”, “sRGB”, “CAL”, “Text”, “DICOM-CL” and “DICOM-BL”. Color settings each mode can be adjusted by using the <Color> menu of the ScreenManager.

### Exit

Press the Enter Button to exit the menu.

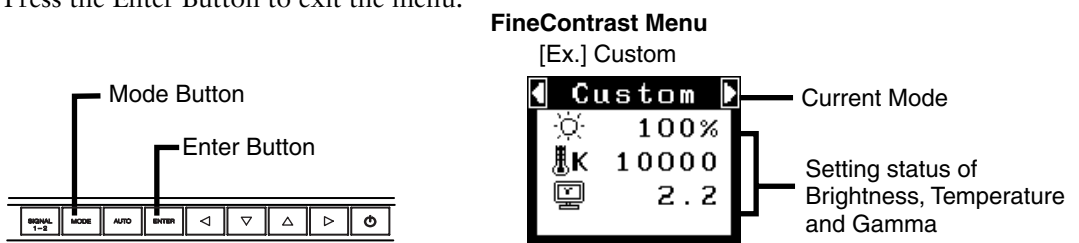

### FineContrast Mode

Selectable FineContrast modes are as follows.

Custom	To adjust the color settings according to your preference
sRGB	To display the screen images based on those original colors (ex. over the Internet)
CAL	The mode only for calibration
Text	Text on word processor or spreadsheet software
DICOM-CL	Suitable for Clear Base X-ray Film
DICOM-BL	Suitable for Blue Base X-ray Film

### Color Adjustment of the Mode Settings

<Brightness>, <Temperature> and <Gamma> settings can be adjusted on the FineContrast Menu. Select the desired function icon with the Up/Down Control Buttons and adjust with the Left/Right Buttons. (Setting(s) of <Temperature> and/or <Gamma> is defined as standard default in some modes. (p.32))

### Detailed Adjustments

The detailed color settings of each mode can be adjusted by using the <Color> menu of the ScreenManager. (p.32)

## 3-4. Useful Functions

### Adjustment Lock

Use the “Adjustment Lock” function to prevent any accidental changes.

Locked function	<ul style="list-style-type: none"> <li>• Adjustments and settings in the ScreenManager.</li> <li>• Auto Adjustment Button</li> <li>• Selecting of the FineContrast mode by the Mode Button / Adjustment.</li> </ul>
Unlocked function	<ul style="list-style-type: none"> <li>• Input Signal Selection Button</li> </ul>

[To lock]

- (1) Switch off the monitor’s power by the power button on the control panel.
- (2) Press on the Auto adjustment button while switching on the monitor’s power.

[To unlock]

- (1) Switch off the monitor’s power by the power button on the control panel.
- (2) Hold down the Auto adjustment button once again and turn the power back on.

### Off Timer

The off timer function causes the monitor to automatically enter a power off state after a predetermined amount of time has lapsed. This function was created to reduce afterimage characteristics that are particular to LCD monitors when the monitor screen is left on for a long period without use.

[Procedure]

- (1) Select <Off Timer> in the ScreenManager <Others> menu.
- (2) Select “Enable” and press the Right and Left Buttons to adjust the “On Period” (1 to 23 hours).

[Off Timer system]

PC	Monitor	Power Indicator
On Period (1H - 23H)	Operation	Blue
Last 15 min. in "On period"	Advance Notice <sup>1)</sup>	Blue Flashing
"On period" expired	Power off	Flashing yellow slowly

<sup>1)</sup>Advance notice (Power Indicator flashing blue) will be given 15 minutes before the monitor automatically enters the “Power Off” mode. To delay entering the “Power Off” mode, press the Power Button during the advance notice period. The monitor will continue to operate for an additional 90 minutes.

[Power Resumption Procedure]

Press the Power Button to return to a normal screen.

#### NOTE

- The off timer function works while the PowerManager is active, but there is no advance notice before the monitor’s power is switched off.

---

## Power Indicator Setting

Light off the power indicator. This function is available for the multiple panels settings.

### [Procedure]

- (1) Select <Power Indicator> in the ScreenManager <Others> menu.
- (2) Select “Disable”.

## Sync Switch Setting

Correct the greenish screen caused by the input signal timing.

### [To set]

- (1) Switch off the monitor’s power by the main power switch.
- (2) Press on the down button while switching on the monitor’s main power switch again.
- (3) The Sync Switch setting has been changed.

### [To cancel]

- (1) Switch off the monitor’s power by the main power switch.
- (2) Press on the down button while switching on the monitor’s main power switch again.
- (3) The Sync Switch setting has been cancelled.

## EIZO Logo Disappearing Function

When switching on the Power Button on the control panel, the EIZO logo is displayed for a while. If you desire to display or undisplay this logo, use this function. (Default is logo appearing.)

### [To undisplay]

Switch off the monitor’s power by the Power Button on the control panel, then hold down the Enter Button once again and turn the power back on.

### [To display again]

Switch off the monitor’s power by the Power Button, then hold down the Enter Button once again and turn the power back on.

# 4. ADJUSTMENT

The monitor displays the digital input image correctly based on its pre-setting data.

## 4-1. Screen Adjustment

### NOTE

- Allow the LCD monitor to stabilize for at least 20 minutes before making image adjustments.

### Analog Input

Screen adjustments for the LCD monitor should be used in suppressing screen flickering and also for adjusting the screen to its proper position. There is only one correct position for each display mode. It is also recommended to use the ScreenManager function when first installing the display or whenever changing the system. For convenience, an easy set-up Program installed on the utility disk to assist in the set-up procedure is provided.

### Adjustment Procedure

#### 1. Press the Auto Adjustment Button on the control panel.

The message “Your setting will be lost, if you press again now.” appears and remains on the screen for 5 seconds. While the message is on the screen, press the Auto Adjustment Button again to automatically adjust the clock, phase, screen position and resolution. If you do not wish to do adjust the screen, do not press the Auto Adjustment Button again.

### NOTE

- The Auto Adjustment function is intended for use on the Macintosh and on AT-compatible PC running Windows. It may not work properly in either of the following cases.  
When running an AT-compatible PC on MS-DOS (Not windows). The background color for the “wall paper” or “desktop” pattern is set to black.

**If the appropriate screen cannot be made by using the Auto Adjustment Button, adjust the screen through the following procedures. If the appropriate screen can be made, proceed to step 4.**

#### 2. Run the “Screen adjustment program”.

Having read the “Readme.txt” file, run the “Screen adjustment program” in the enclosed EIZO LCD Utility Disk. Step by step, adjustment is provided by the wizard guide. (If using the Windows, the program can be directly run from the menu screen of the CD-ROM.)

**NOTE**

- If the user's operating system has no utility disk (e.g. OS/2), we recommend setting the desktop pattern to that as shown in the diagram on the following.

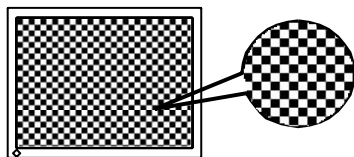

### 3. Adjust by using <Screen> menu in the ScreenManager.

(1) Vertical bars appear on the screen

→  Use the <Clock> (p.48) adjustment.

Select the “Clock” and eliminate the vertical bars by using the Right and Left of the Control Buttons. Do not continuously press the Control Buttons, as the adjustment value will change quickly and make it difficult to locate the most suitable adjustment point.

If the horizontal flickering, blur or bars appear, proceed to “Phase” adjustment as follows.

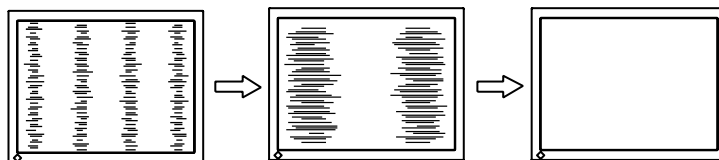

(2) Horizontal flickering, blurring or bars appear on the screen.

→  Use the <Phase> (p.49) adjustment.

Select the <Phase> and eliminate the horizontal flickering, blurring or bars by using the Right and Left Buttons.

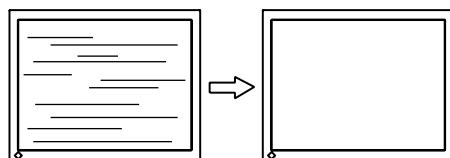
**NOTE**

- Horizontal bars may not completely disappear from the screen depending on the PC.

- (3) The screen position is not incorrect.  
 →  Use the <Position> adjustment.

The correct displayed position of the monitor is decided because the number and the position of the pixels are fixed. The <Position> adjustment moves the image to the correct position.

Select <Position> and adjust the position of the upper left corner of the image by using the Up, Down, Right and Left Buttons in order to align the screen.

If vertical bars of distortion appear after finishing the <Position> adjustment, return to <Clock> adjustment and repeat the previously explained adjustment procedure (“Clock” → “Phase” → “Position”)

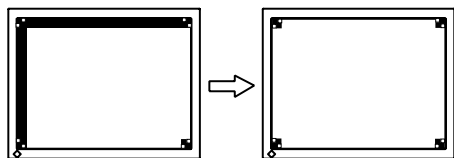

- (4) Screen image is smaller or larger than the actual screen images.  
 →  Use the <Resolution> adjustment.

Adjustment is needed when the input signal resolution and the resolution now being displayed are different.

Select <Resolution> and confirm if the resolution now being displayed is the same as the input resolution. If it is not, adjust the vertical resolution using the Up and Down Button and adjust the horizontal resolution using the Right and Left Buttons.

Smaller than the actual screen images.

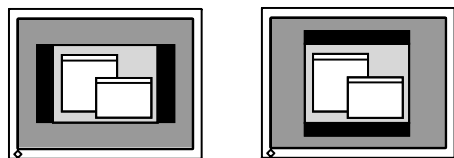

Larger than the actual screen images.

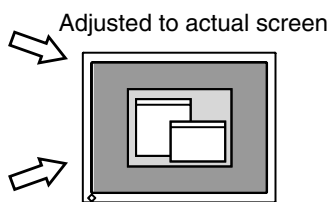
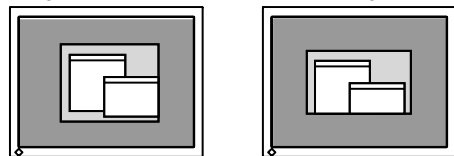

---

**4. Adjust the output signal range (Dynamic Range) of the signal.**  
→  Use the <Range Adjustment> (p.49) of <Screen> menu.

This controls the level of output signal range to display the whole color gradation (256 colors).

**[Procedure]**

Select the <Range Adjustment> in the ScreenManager and press the Auto Adjustment button on the control panel to adjust the Range Adjustment. The screen blanks for a moment and adjusts the color range to display the whole color gradation of the current output signal.

## 4-2. Displaying Low Resolutions

The lower resolutions are enlarged to full screen automatically. Using the <Screen Size> function in the <Others> menu enables to change the screen size.

### 1. Enlarge the screen size when displaying a low resolution.

→  Select the <Screen Size>.

Select the <Screen Size> in the others menu and select the screen size by using the Up and Down Buttons.

Menu	Function
Full	Displays the picture on the screen in full, irrespective of the picture's resolution. Since the vertical resolution and the horizontal resolution are enlarged at different rates, some images may appear distorted.
Enlarged	Displays the picture on the screen in full, irrespective of the picture's resolution. Since the vertical resolution and horizontal resolution are enlarged at same rates, some horizontal or vertical image may disappear.
Normal	Displays the picture at the actual Screen resolution.

Example: Displaying 1024 x 768

Full (Default Setting)

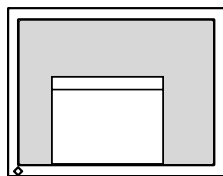

(1280 × 1024)

Enlarged

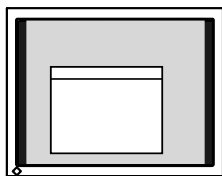

(1280 × 960)

Normal

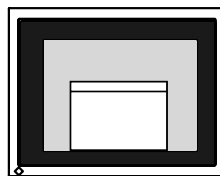

(1024 × 768)

### 2. Smooth the blurred texts of the enlarged screen.

→  Switch the <Smoothing> setting.

Select the suitable level from 1 – 5 (Soft – Sharp).

Select <Smoothing> in the <Screen> menu and adjust by using the Right and Left Buttons.

#### NOTE

- <Smoothing> is disabled when the screen is displayed in the following resolutions.
  - \*1280 x 1024
  - \*The image size is doubled both in horizontally and vertically to (i.e. 1280 x 960 enlarged from 640 x 480) provide clear focus which does not require this function.



**3. Set the brightness of the black area surrounding the displayed image.**

→  Set the <Border Intensity>.

In the <Enlarge> mode or <Full Screen> mode, the outer area (border) is usually black.

Select <Border Intensity> in the <Others> menu and adjust by using the Right and Left Buttons.

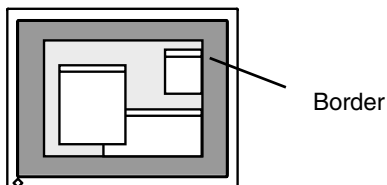

## 4-3. Color Adjustment









Color settings of each FineContrast mode can be adjusted and saved by using the <Color> menu of the ScreenManager.

**In the analog input, perform the “Range Adjustment” (p.29) before making the color adjustments.**

### Adjustment items

The adjustable items and displayed icons on the ScreenManager depend on the selected FineContrast mode.

“√”: Settable/Adjustable “–”: Fixed at the factory









Icons	Functions		FineContrast Modes					
			Custom	sRGB	CAL	Text	DICOM-CL	DICOM-BL
	Brightness	*	√	√	√	√	√	√
	Temperature	*	√	–	–	√	–	–
	Gamma	*	√	–	–	√	–	–
	Saturation		√	–	–	√	–	–
	Hue		√	–	–	√	–	–
	Gain		√	–	–	–	–	–
	6 colors		√	–	–	–	–	–
	Unlock		–	–	√	–	–	–
	Reset		√	–	–	√	–	–

\*These settings can be also adjusted on the FineContrast menu. (p.23)

#### NOTE

- Allow the LCD monitor to stabilize for at least 20 minutes before making image adjustments. (Allow the monitor to warm up for at least 20 minutes before making adjustments.)
- Performing the <Reset> of the <Color> menu returns the color settings of the selected mode to the default settings.
- The values shown in percentages represent the current level within the specific adjustment. They are available only as a reference tool. (To create a uniform white or black screen, the percentages for each will probably not be the same.)

## Adjustment Contents

Menu	Function Descriptions	Adjustable Range
Brightness 	To set the brightness of the screen	0 ~ 130%
Temperature (p.49) 	To set the color temperature	4,000 ~ 15,000 K in 500 K increments (including 9,300 K). Default setting is 7,500K.
	<p><b>NOTE</b></p> <ul style="list-style-type: none"> <li>• The values shown in the Kelvin are available only as a reference tool.</li> <li>• Adjusting the &lt;Gain&gt; turns the &lt;Temperature&gt; adjustment "Off".</li> <li>• Setting the temperature under 4,000 K or over 15,000 K invalidates the color temperature setting. (The color temperature's setting turns "OFF".)</li> </ul>	
Gamma (p.48) 	To set the gamma value	1.8 ~ 2.6
	<p><b>NOTE</b></p> <ul style="list-style-type: none"> <li>• If setting the gamma value, the using the monitor in the digital signal input is recommended. If using the monitor in the analog input signal, set the gamma value from 1.8 to 2.2.</li> </ul>	
Saturation 	To change the saturation	-16 ~ 16 Setting the minimum level (-16) turns the image to the monochrome.
	<p><b>NOTE</b></p> <ul style="list-style-type: none"> <li>• The &lt;Saturation&gt; adjustment may cause undisplable color tone.</li> </ul>	
Hue 	To change the flesh color, etc.	-20 ~ 20
	<p><b>NOTE</b></p> <ul style="list-style-type: none"> <li>• The &lt;Hue&gt; adjustment may cause undisplable color tone.</li> </ul>	
Gain (p.48) 	To change each color (red, green and blue)	0 ~ 100% By adjusting the red, green and blue color tones for each mode, custom colors can be defined. Display a white or gray background image and adjust the <Gain>.
	<p><b>NOTE</b></p> <ul style="list-style-type: none"> <li>• The values shown in the percentage are available only as a reference tool.</li> <li>• Setting the &lt;Temperature&gt; (p.49) invalidates the &lt;Gain&gt; adjustment. &lt;Gain&gt; setting returns to the default.</li> </ul>	
6 colors 	To adjust <Saturation> and <Hue> in each color (Red, Yellow, Green, Cyan, Blue and Magenta)	Hue: -20 ~ 20 Saturation: -16 ~ 16
Unlock 	Unlock the lock at the CAL mode.	Select <Unlock>. (p.34)
Reset 	To return the color settings of the selected mode to the default settings	Select the <Reset>.

## Unlock Function after Calibration

The calibration is available when using the specified optional calibration kit. (p.47)  
After the calibration in FineContrast CAL mode, the brightness adjustment function is automatically locked. Unlock function is available by using ScreenManager.

### How to unlock

- (1) Select the <Unlock> of <Color> menu.
- (2) Select “Unlock”.



### NOTE

- Performing the <Reset> of <Others>, locked function is also unlocked.
- After the unlock, the <Unlock> is disabled.

## 4-4. Power-save Setup

The <PowerManager> menu in the ScreenManager enables to set the power-save setup.

### NOTE

- Do your part to conserve energy, turn off the monitor when you are finished using it. Disconnecting the monitor from the power supply is recommended to save energy completely.
- Even if the monitor is in a power saving mode, USB compliant devices function when they are connected to the monitor's USB (both the upstream and the downstream ports). Therefore, power consumption of the monitor will change according to the connected devices even if the monitor is in a power saving mode.

### Analog Input

This monitor complies with the "VESA DPMS" (p.49).

#### [Procedure]

- (1) Set the PC's power saving settings.
- (2) Select "VESA DPMS" in the <PowerManager> menu.

#### [Power saving system]

PC		Monitor	Power Indicator
Operation		Operation	Blue
Power saving	STAND-BY SUSPEND OFF	Power saving	Yellow

#### [Procedure]

Operate the mouse or keyboard to return to a normal screen.

### Digital input

This monitor complies with the "DVI DMPM" (p.48).

#### [Procedure]

- (1) Set the PC's power saving settings.
- (2) Select "DVI DMPM" in the <PowerManager> menu.

#### [Power saving system]

PC		Monitor	Power Indicator
On		Operation	Blue
Power saving		Power saving	Yellow
Off mode		Power saving <sup>1</sup>	Flashing yellow (2 times for each)

<sup>1</sup>Power saving through the PC's off mode is only supported when "Manual" is selected on the ScreenManager's <Input Priority>.

#### [Procedure]

Operate the mouse or keyboard to return to a normal screen.

Power on the PC to return a normal screen from the Off mode of the PC.

# 5. MAKING USE OF USB (Universal Serial Bus)

This monitor provides a hub which supports the USB standard. When connecting to a USB compliant PC or another hub, the monitor functions as a hub to which the USB compliant peripherals can be easily connected.

## Required system environment

- PC equipped with USB ports or another USB hub connected to the USB compliant PC
- Windows 98/2000/Me/XP // Mac OS 8.5.1 or later
- USB Cable (MD-C93, enclosed)

### NOTE

- The USB hub function may not work properly depending on the PC or peripherals. Please consult the manufacturer of each device about the USB support.
- Using the USB Rev. 2.0 compatible PC or peripherals is recommended.
- When the monitor is not on, the peripherals connected to the downstream ports will not operate.
- Even if the monitor is in a power saving mode, the devices connected to the monitor's USB ports (both the upstream and the downstream) will function.
- The followings are procedures for the Windows 98/Me/2000/XP and Mac OS.

## Connecting to the USB HUB

1. Connect the monitor to the PC with the signal cable (p.13) first, then turn on the PC.
2. Connect the upstream port of the monitor to the downstream port of the USB compliant PC or another hub by using the USB cable.

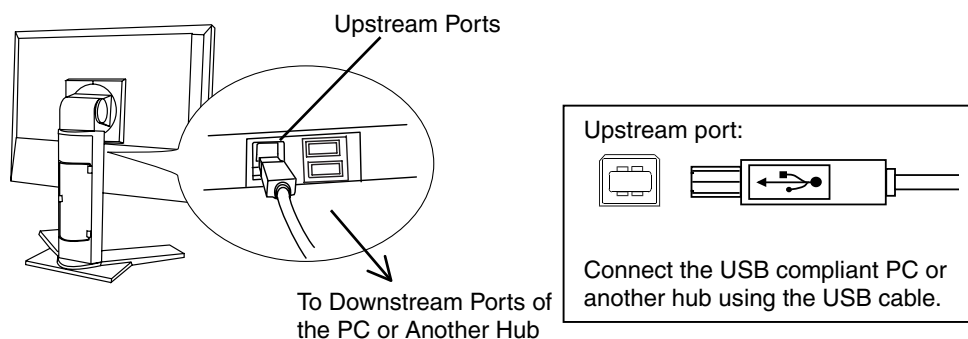

After connecting the USB cable, the USB function can be set up automatically.

- 3.** After setting up, the monitor's USB hub is available for connecting USB compliant peripherals to the downstream ports of the monitor.

### Connecting Examples

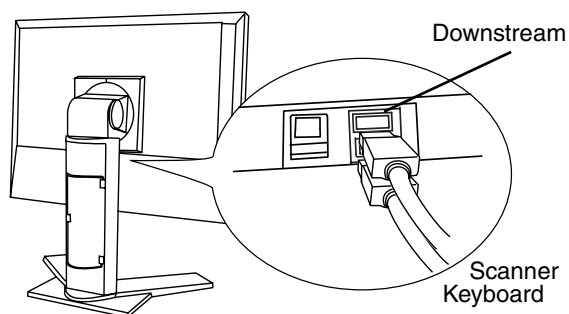
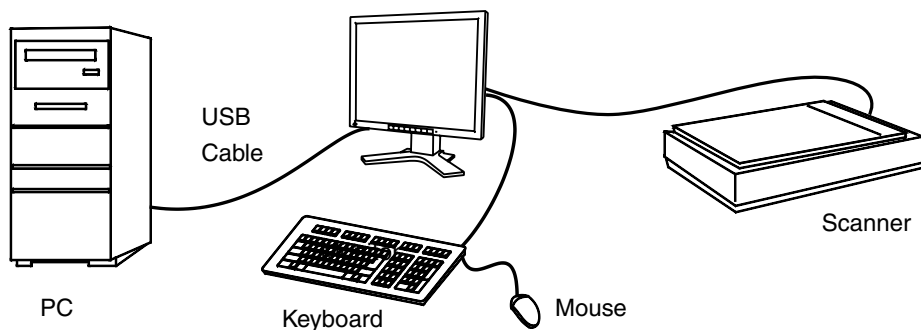

Downstream ports:

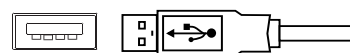

Connect the cables from USB compliant peripherals such as a mouse, keyboard, etc.

### ScreenManager Pro for LCD (for Windows)

For further details about the “ScreenManager Pro for LCD (for Windows)”, refer to the EIZO LCD Utility Disk.

# 6. ATTACHING AN ARM

The LCD monitor can be used with an arm by removing the tilt stand and attaching the arm or stand to the LCD monitor.

## **NOTE**

- If you will use the arm or stand of other manufacturers, confirm the followings to the manufacturers before selecting.
  - Hole spacing on the arm mounting: 100 mm x 100 mm (VESA compliant)
  - Supportable Weight: Total weight of the monitor (without stand) and attaching equipment such as a cable
  - TÜV/GS approved arm or stand
- Please connect cables after attaching an arm stand.

## Setup Procedure

- 1.** Hold the center of the stand mounting cover and slide them rightward or leftward to remove the mounting cover.

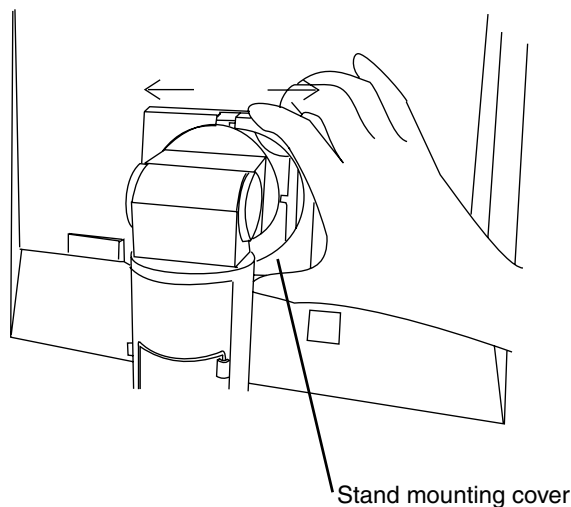

- 2.** Lay the LCD monitor down. Do not scratch the panel.
- 3.** Remove the tilt stand by loosening the screws.  
(4 pcs of M4 x 15 BZn/Fe)



**4.** Attach an arm stand to the LCD monitor securely.

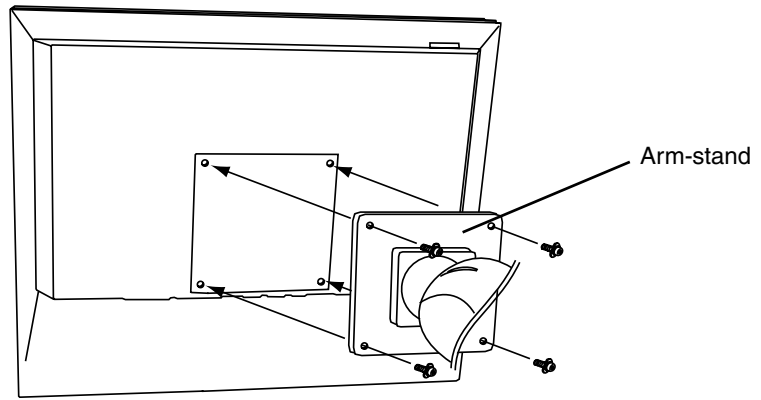





M4 Mounting Screws: M4 x 15 (mm) BZn/Fe

# 7. TROUBLESHOOTING

If a problem persists even after applying the suggested remedies, contact an EIZO dealer.

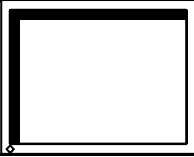
- No picture problems → See No.1 ~ No.2
- Imaging problems → See No.3 ~ No.14
- Other problems → See No.15 ~ No.20
- USB problems → See No.21 ~ No.22

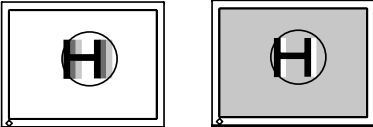
Problems	Points to check with possible solutions
<p><b>1. No picture</b></p> <ul style="list-style-type: none"> <li>• Indicator status: Off</li> </ul>	<ul style="list-style-type: none"> <li><input type="checkbox"/> Check that the power cord is correctly connected. If the problem persists, turn off the monitor power for a few minutes, then turn it back on and try again.</li> </ul>
<ul style="list-style-type: none"> <li>• Indicator status: Blue</li> <li>• Indicator status: Yellow</li> <li>• Indicator status: Slowly flashing Yellow</li> <li>• Indicator status: Flashing Yellow (twice for each)</li> </ul>	<ul style="list-style-type: none"> <li><input type="checkbox"/> Check the “Brightness” setting.</li> <li><input type="checkbox"/> Switch the signal input by pressing the Input Signal Selection Button on the front control panel.</li> <li><input type="checkbox"/> Try pressing a key on the keyboard, or clicking the mouse. (p.35)</li> <li><input type="checkbox"/> Try pressing the Power Button.</li> <li><input type="checkbox"/> Try turning the PC on.</li> </ul>
<p><b>2. Error messages shown below will remain on the screen for 40 seconds.</b></p> <div data-bbox="209 1141 550 1319" style="border: 1px solid black; padding: 5px; margin: 10px 0;"> <p style="text-align: center;"><b>Signal Check</b></p> <p style="text-align: center;">Signal 2</p> <p>fH: 0.0kHz fU: 0.0Hz</p> </div>	<p>These messages appear when the signal is not inputted correctly, even if the monitor functions properly.</p> <ul style="list-style-type: none"> <li><input type="checkbox"/> When the image is displayed correctly after a short time, there is no problem with the monitor. (Some PCs do not output the signal soon after powering on.)</li> <li><input type="checkbox"/> Check that the PC is turned ON.</li> <li><input type="checkbox"/> Check that the signal cable is properly connected to the PC or graphics board.</li> <li><input type="checkbox"/> Switch the signal input by pressing the Input Signal Selection Button on the front control panel.</li> </ul>
<ul style="list-style-type: none"> <li>• Whenever an error signal message appears, the signal frequency will be displayed in red. (Example)</li> </ul> <div data-bbox="209 1547 550 1725" style="border: 1px solid black; padding: 5px; margin: 10px 0;"> <p style="text-align: center;"><b>Signal Error</b></p> <p style="text-align: center;">Signal 2</p> <p>fD: 165.0MHz fH: 75.0kHz fU: 60.0Hz</p> </div>	<ul style="list-style-type: none"> <li><input type="checkbox"/> Use the graphics board’s utility software to change the frequency setting. (Refer to the manual of the graphics board.)</li> </ul>

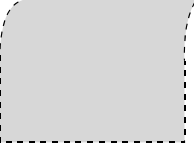
Problems	Points to check with possible solutions
<p><b>3. Display position is incorrect.</b></p> 	<ul style="list-style-type: none"> <li><input type="checkbox"/> Adjust the image position using the &lt;Position&gt; (p.28)</li> <li><input type="checkbox"/> If the problem persists, use the graphics board's utility software to change the display position if available.</li> </ul>
<p><b>4. Screen image is smaller or larger than the actual screen images.</b></p>	<ul style="list-style-type: none"> <li><input type="checkbox"/> Adjust the resolution using the &lt;Resolution&gt;. (p.28)</li> </ul>
<p><b>5. Vertical bars of distortion appear.</b></p> 	<ul style="list-style-type: none"> <li><input type="checkbox"/> Decrease the vertical bars using the &lt;Clock&gt;. (p.27)</li> </ul>
<p><b>6. The characters and images have several vertical bars on their right side.</b></p> 	<ul style="list-style-type: none"> <li><input type="checkbox"/> Adjust the characters and images using the &lt;Signal Filter&gt;.</li> </ul>
<p><b>7. Horizontal bars of distortion appear.</b></p> 	<ul style="list-style-type: none"> <li><input type="checkbox"/> Decrease the horizontal bars using the &lt;Phase&gt;. (p.27)</li> </ul>
<p><b>8. Letters and lines appear blurred.</b></p>	<ul style="list-style-type: none"> <li><input type="checkbox"/> Adjust the blurred lines using &lt;Smoothing&gt; (p.30)</li> </ul>
<p><b>9. Distortion appears like the figure below.</b></p> 	<ul style="list-style-type: none"> <li><input type="checkbox"/> This happens when both composite (X-OR) input signal and separate vertical synchronizing signal are input. Please select one of the two.</li> </ul>

Problems	Points to check with possible solutions
<b>10. The screen is too bright or too dark.</b>	<input type="checkbox"/> Adjust the <Brightness> (The backlight of the LCD monitor has a fixed life span. When the screen becomes dark or begins to flicker, please contact your dealer.) <input type="checkbox"/> Some input signal timing causes greenish screen. Change the Sync Switch setting. (p.25).
<b>11. Afterimages appear.</b>	<input type="checkbox"/> When the screen image is changed after displaying the same image for a long period, an afterimage may appear. The “Afterimage” can be removed gradually by changing the displayed image. Use the “Off Timer” function and avoid keeping the screen on all the time. (p.24)
<b>12. The screen has defective pixels (e.g. slightly light or dark).</b>	<input type="checkbox"/> This is due to the characteristics of the panel itself and not the LCD product.
<b>13. Fingerprints remain on the screen.</b>	<input type="checkbox"/> Leaving the screen white may solve the problem.
<b>14. The noise appears on the screen.</b>	<input type="checkbox"/> Change the mode in <Signal Filter> in the <Screen> menu.
<b>15. The &lt;Smoothing&gt; cannot be selected.</b>	<input type="checkbox"/> <Smoothing> is disabled when the screen is displayed in the 1280 x1024. <input type="checkbox"/> <Smoothing> is disabled when “Normal” is selected in the <Screen Size> menu. <input type="checkbox"/> The image size is doubled both in horizontally and vertically to (i.e. 1280 x 960 enlarged from 640 x 480) provide clear focus which does not require this function.
<b>16. The Main menu of ScreenManager does not operate.</b>	<input type="checkbox"/> The adjustment lock is probably on. (p.24) <input type="checkbox"/> Check that the FineContrast mode is not activated. (p. 21)
<b>17. The Auto Adjustment Button does not operate.</b>	<input type="checkbox"/> The Auto adjustment button does not operate when the digital signal is input. <input type="checkbox"/> The adjustment lock is probably on. (p.24)
<b>18. The Mode Button does not operate.</b>	<input type="checkbox"/> The adjustment lock is probably on. (p.24)

Problems	Points to check with possible solutions
<p><b>19. The &lt;Brightness&gt; cannot be selected in FineContrast CAL mode.</b></p>	<p><input type="checkbox"/> After the calibration, the brightness adjustment function is automatically locked. Please refer to page 34 to unlock.</p>
<p><b>20. Frequency does not change after installing “Monitor information file” in the attached utility disk on Windows 98/2000/Me/XP.</b></p>	<p><input type="checkbox"/> Use the graphics board’s utility software to change the input signal frequency.</p>
<p><b>21. PC is hung up. / The peripherals connected to the downstream ports do not operate.</b></p>	<p><input type="checkbox"/> Check that the USB cable is correctly connected.</p> <p><input type="checkbox"/> Check the downstream ports by connecting the peripherals to other downstream ports. If the problem is solved by doing this, contact an EIZO dealer. (For details, refer to the manual of the PC.)</p> <p><input type="checkbox"/> Try executing the following method.</p> <ul style="list-style-type: none"> <li>- Restarting the PC</li> <li>- Connecting the PC and peripherals directly</li> </ul> <p>If the problem is solved by doing this, contact an EIZO dealer.</p>
<p><b>22. USB function cannot be setup.</b></p>	<p><input type="checkbox"/> Check that the USB cable is correctly connected.</p> <p><input type="checkbox"/> Check that the PC and OS are USB compliant. (For verification of USB support, consult the manufacturer of each system.)</p> <p><input type="checkbox"/> Check the PC’s BIOS setting for USB. (For details, refer to the manual of the PC.)</p>

# 8. CLEANING

Periodic cleaning is recommended to keep the monitor looking new and to prolong its operation lifetime.

## **NOTE**

- Never use thinner, benzene, alcohol (ethanol, methanol, or isopropyl alcohol), abrasive cleaners, or other strong solvents, as these may cause damage to the cabinet or LCD panel.

## **Cabinet**

To remove stains, wipe the cabinet with a soft, lightly moistened cloth using a mild detergent. Do not spray wax or cleaner directly into the cabinet. (For details, refer to the manual of the PC.)

## **LCD Panel**

- The LCD surface can be cleaned with a soft cloth, such as cotton or lens paper.
- If necessary, stubborn stains can be removed by moistening part of a cloth with water to enhance its cleaning power.

# 9. SPECIFICATIONS

LCD Panel	48 cm (19.0 inch), TFT color LCD panel with Anti-Glare Hard Coating 2H, Viewing Angle: Horizontal: 170°, Vertical: 170° (CR≥10)	
Dot Pitch	0.294 mm	
Horizontal Scan Frequency	Analog: 30 ~ 82 kHz (Automatic) Digital: 31 ~ 76 kHz	
Vertical Scan Frequency	Analog: 49 ~ 86 Hz (Automatic) (1280 x 1024: 49 ~ 75 Hz) Digital: 59 ~ 61 Hz, (VGA TEXT: 69 ~ 71 Hz)	
Resolution	1M pixels (1280 dots × 1024 lines)	
Dot Clock (Max.)	Analog: 135 MHz Digital: 108 MHz	
Display Colors	16 million colors (max)	
Display Area	376 mm (H) × 301 mm (V) (14. 8" (H) × 11.9" (V))	
Power Supply	100-120/200-240 VAC±10%, 50/60 Hz, 0.6-0.5A /0.35-0.3 A	
Power Consumption	Min.: 55 W Max.: 60 W (With USB) Power Saving Mode: Less than 8 W (for single signal input without USB)	
Input Connector	DVI-I × 2	
Analog Input Signal (Sync)	a) Separate, TTL, Positive/Negative	
	b) Composite, TTL, Positive/Negative	
	c) Sync on Green, 0.3 Vp-p, Negative	
Analog Input Signal (Video)	0.7Vp-p/75Ω Positive	
Input Signal (Digital)	TMDS (Single Link)	
Signal registration	Analog: 45 (Factory preset: 26) Digital: 10 (Factory preset: 0)	
Plug & Play	VESA DDC 2B	
Dimensions	with stand	414 mm (W) x 409.5~ 509.5 mm (H) x 202.7 mm (D) (16.3"(W) x 16.1" ~ 20.1" (H) x 8.0"(D))
	without stand	414mm (W) x 340mm (H) x 64mm (D) (16.3"(W) x 13.4"(H) x 2.52"(D))
Weight	with stand	8.1 kg (17. 9 lbs.)
	without stand	5.8 kg (12.8 lbs.)
Environment Conditions	Temperature	Operating: 0 °C ~ 35 °C (32 °F ~ 95 °F) Storage: -20 °C ~ 60 °C (-4 °F ~ 140 °F)
	Humidity	30 % to 80 % R.H. Non-condensing
	Pressure	860 to 1,060 hPa
USB	Standard	Rev. 2.0 complied self-powered hub
	USB ports	Upstream port × 1, Downstream port × 2
	Communication Speed	480 Mbps (high), 12 Mbps (full), 1.5 Mbps (low)
	Power Supply	Downstream: 500 mA for each (Max.)

Certifications and Standards	TÜV Rheinland /GM, CB, NRTL/C-TÜV, CE (93/42/EEC), FCC-B
Classification of Equipment	Type of protection against electric shock: Class I EMC class: EN60601-1-2: 2001 Group 1 Class B Classification of medical device (MDD 93/42/EEC): Class I

### Default Settings

		Analog input	Digital input
FineContrast Mode		Custom	
Brightness		100%	
Temperature		7,500K	
Smoothing		3	
PowerManager		VESA DPMS	DVI DMPM
Screen Size		Full	
Input Priority		1	
Off Timer		Disable	
Menu Settings	Menu Size	Normal	
	Menu Off Timer	45 seconds	
Beep		On	
Language		English	

### Beeper Settings

Short beep	ScreenManager item selected. ScreenManager parameter adjusted to minimum or maximum limit. Input Signal Selection Button pressed.
Long beep	Auto Adjustment Button pressed. ScreenManager data-save executed.
4 short beeps	Monitor not connected correctly. PC turned off. Monitor received unsupported signal frequency.
2 short beeps every 15 sec.	Monitor is in the advance notice mode of the Off Timer. The power will be off within fifteen minutes.



## Dimensions

mm (inches)

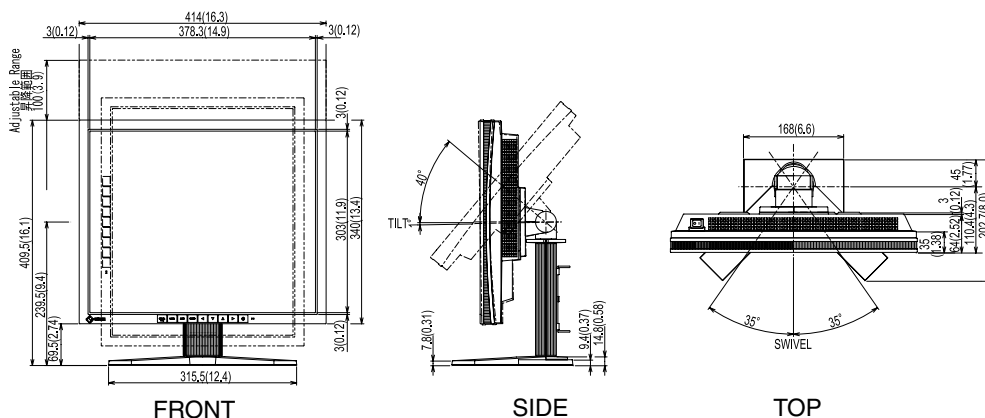

## Pin Assignment

### DVI-I Connector

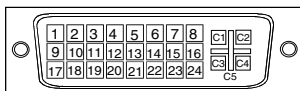

Pin No.	Signal	Pin No.	Signal	Pin No.	Signal
1	TMDS Data2-	11	TMDS Data1/3 Shield	21	NC
2	TMDS Data2+	12	NC	22	TMDS Clock shield
3	TMDS Data2/4 Shield	13	NC	23	TMDS Clock+
4	NC*	14	+5V Power	24	TMDS Clock-
5	NC	15	Ground (return for +5V, Hsync and Vsync)	C1	Analog Red
6	DDC Clock (SCL)	16	Hot Plug Detect	C2	Analog Green
7	DDC Data (SDA)	17	TMDS Data0-	C3	Analog Blue
8	Analog Vertical Sync	18	TMDS Data0+	C4	Analog Horizontal Sync
9	TMDS Data1-	19	TMDS Data0/5 Shield	C5	Analog Ground (analog R, G, & B return)
10	TMDS Data1+	20	NC		(*NC: No Connection)

## USB Port

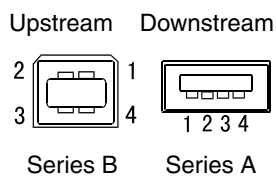

No.	Signal	Signal
1	VCC	Cable power
2	- Data	Serial data
3	+ Data	Serial data
4	Ground	Cable Ground

## Optional

Calibration Kit	RadiCS RX1
-----------------	------------

# 10. GLOSSARY

## **Clock**

With the analog input signal display, the analog signal is converted to a digital signal by the LCD circuitry. To convert the signal correctly, the LCD monitor needs to produce the same number clock pulse as the dot clock of the graphics system. When the clock pulse is not correctly set, some vertical bars of distortion are displayed on the screen.

## **DICOM**

(Digital Imaging and Communication in Medicine)

The DICOM standard was developed by the American College of Radiology and the National Electrical Manufacturer's Association of the USA.

The DICOM compatible device connection enables to transfer the medical image and information. The DICOM, Part 14 document defines the digital, grayscale medical image display.

## **DVI**

(Digital Visual Interface)

A digital flat panel interface. DVI can transmit digital data from the PC directly without loss with the signal transition method "TMDS".

There are two kinds of DVI connectors. One is DVI-D connector for digital signal input only. The other is DVI-I connector for both digital and analog signal inputs.

## **DVI DMPM**

(DVI Digital Monitor Power Management)

The Power management system for the digital interface. The "Monitor ON" status (operation mode) and the "Active Off" status (power-saving mode) are indispensable for the DVI-DMPM as the monitor's power mode.

## **Gain Adjustment**

Adjusts each color parameter for red, green and blue. The color of the LCD monitor is displayed through the color filter of the LCD panel. Red, green and blue are the three primary colors. The colors on the monitor are displayed by combining these three colors. The color tone can change by adjusting the illumination amount passed through each color's filter.

## **Gamma**

Generally, the relationship that the light intensity values of a monitor change nonlinearly to the input signal level is called "Gamma Characteristic". On the monitor, low gamma values display the whitish images and high gamma values display the high contrast images.

**Phase**

The phase adjustment decides the sampling timing point for converting the analog input signal to a digital signal. Adjusting the phase after the clock adjustment will produce a clear screen.

**Range Adjustment**

The Range Adjustment controls the level of output signal range to display the whole color gradation.

**Resolution**

The LCD panel consists of a fixed number of pixel elements which are illuminated to form the screen image. The EIZO R12 display panel consists of 1280 horizontal pixels and 1024 vertical pixels. At a resolution of 1280 x 1024, all pixels are displayed as a full screen.

**sRGB (Standard RGB)**

“International Standard for Red, Green and Blue color space”

A color space was defined with the aim of the color matching between applications and hardware devices, such as monitors, scanners, printers and digital cameras. As a standard default space, sRGB allows Internet users to closely match colors.

**Temperature**

Color temperature is a method to measure the white color tone, generally indicated in degrees Kelvin. At high temperatures the white tone appears somewhat blue, while at lower temperatures it appears somewhat red. Computer monitors generally give best performance at high temperature settings.

5,000 K: Slightly reddish white.

6,500 K: Warm-white tone, similar to white paper or daylight.

9,300 K: Slightly bluish white.

**TMDS**

(Transition Minimized Differential Signaling)

A signal transition method for the digital interface

**VESA DPMS**

(Video Electronics Standards Association – Display Power Management Signaling)

The acronym VESA stands for “Video Electronics Standards Association” and DPMS stands for “Display Power Management Signaling.” DPMS is a communication standard that PCs and graphics boards use to implement power savings on the monitor side.

---

# APPENDIX/ANHANG/ANNEXE

## Preset Timing Chart for Analog input Timing-Übersichten für Analog Eingang Synchronisation des Signaux pour Analog numerique

Based on the signal diagram shown below 26 factory presets have been registered in the monitor's microprocessor.

Der integrierte Mikroprozessor des Monitors unterstützt 26 werkseitige Standardeinstellungen (siehe hierzu die nachfolgenden Diagramme).

26 signaux ont été enregistrés en usine dans le microprocesseur du moniteur, conformément au diagramme de synchronisation ci-dessous.

Mode	Dot Clock MHz	Frequencies		Sync Polarity	
		H kHz	V Hz	H	V
VGA 640 × 480 @60 Hz	25.2	31.47	59.94	Nega.	Nega.
VGA 720 × 400 @70 Hz	28.3	31.47	70.09	Nega.	Posi.
Macintosh 640 × 480 @67 Hz	30.2	35.00	66.67	Nega.	Nega.
Macintosh 832 × 624 @75 Hz	57.3	49.73	74.55	Posi.	Posi.
Macintosh 1152 × 870 @75 Hz	100.0	68.68	75.06	Nega.	Nega.
Macintosh 1280 × 960 @75 Hz	126.2	74.76	74.76	Posi.	Posi.
VESA 640 × 480 @72 Hz	31.5	37.86	72.81	Nega.	Nega.
VESA 640 × 480 @75 Hz	31.5	37.50	75.00	Nega.	Nega.
VESA 640 × 480 @85 Hz	36.0	43.27	85.01	Nega.	Nega.
VESA 720 × 480@60Hz	28.3	31.47	59.94	Nega.	Nega.
VESA 800 × 600 @56 Hz	36.0	35.16	56.25	Posi.	Posi.
VESA 800 × 600 @60 Hz	40.0	37.88	60.32	Posi.	Posi.
VESA 800 × 600 @72 Hz	50.0	48.08	72.19	Posi.	Posi.
VESA 800 × 600 @75 Hz	49.5	46.88	75.00	Posi.	Posi.
VESA 800 × 600 @85 Hz	56.3	53.67	85.06	Posi.	Posi.
VESA 1024 × 768 @60 Hz	65.0	48.36	60.00	Nega.	Nega.
VESA 1024 × 768 @70 Hz	75.0	56.48	70.07	Nega.	Nega.
VESA 1024 × 768 @75 Hz	78.8	60.02	75.03	Posi.	Posi.
VESA 1024 × 768 @85 Hz	94.5	68.68	85.00	Posi.	Posi.
VESA 1152 × 864 @75 Hz	108.0	67.50	75.00	Posi.	Posi.
VESA 1280 × 960 @60 Hz	108.0	60.00	60.00	Posi.	Posi.
VESA 1280 × 1024 @60 Hz	108.0	63.98	60.02	Posi.	Posi.
VESA 1280 × 1024 @75 Hz	135.0	79.98	75.03	Posi.	Posi.
SUN WS 1152 × 900 @66 Hz	94.2	62.00	66.10	Nega.	Nega.
SUN WS 1152 × 900 @76 Hz	107.5	71.90	76.20	Nega.	Nega.
SUN WS 1280 × 1024 @67 Hz	117.0	71.70	67.20	Nega.	Nega.

**Recycle Auskunft**

Die Rücknahme dieses Produktes nach Nutzungsende übernimmt EIZO in Deutschland zusammen mit dem Partner MIREC GmbH & Co. KG. Dort werden die Geräte in ihre Bestandteile zerlegt, die dann der Wiederverwertung zugeführt werden. Um einen Abholtermin zu vereinbaren und die aktuellen Kosten zu erfahren, benutzen Sie bitte folgende Rufnummer: 02153-73 35 00. Weitere Informationen finden Sie auch unter der Internet-Adresse: [www.eizo.de](http://www.eizo.de).

**Recycling Information for customers in Switzerland:**

All recycling information is placed in the SWICO's website.  
<http://www.swico.ch>

**Recycling-Information für Kunden in der Schweiz:**

Alle Informationen zum Thema Recycling finden Sie auf der Homepage des Branchenverbandes SWICO.  
<http://www.swico.ch>

**Renseignements de recyclage pour les clients en Suisse:**

Vous trouvez tous les renseignements pour le sujet de recyclage sur la page WEB de l'UNION DE BRAN CHE SWICO.  
<http://www.swico.ch>

**Recycling Information for customers in USA:**

All recycling information is placed in the EIZO Nanao Technologies, Inc's website.  
<http://www.eizo.com/contact/index.html>

**Återvinnings information för kunder i Sverige:**

All information om återvinning finns på Eizo Europe AB:s hemsida:  
[www.eizo.se](http://www.eizo.se)



**EIZO NANA O CORPORATION**

153 Shimokashiwano, Hakusan, Ishikawa 924-8566 Japan  
Phone: +81 76 277 6792 Fax: +81 76 277 6793

**EIZO GmbH**

Siemensallee 84, 76187 Karlsruhe, Germany  
Phone: +49 721 20321 0 Fax: +49 721 20321 471

**This document is printed on recycled chlorine free paper.**

<http://www.radiforce.com>

2nd Edition-March, 2010 Printed in Japan.

05C21411BJ  
(FA-2193-EU)