

- For Administrator -

For Microsoft Windows CE.NET
Version E

User's Manual

eClient[®] 630LT-GR 630LT-GR-N

Touch Panel
LCD Monitor integrated
Windows-based Terminal

IMPORTANT

Please confirm the version of the software built in eClient, and refer to the suited User's Manual (Refer to the User's Manual Version List on next page).

This is the manual for the following software version.

- * Microsoft Windows CE: 4.10 Rev. 2.7.1 or later
- * Microsoft Terminal Server Client: Ver. 7.2.0 or later
- * ICA Client: Ver. 7.23 or later

CAUTION

Please carefully read the PRECAUTION section in the user's manual enclosed with the unit before using the unit.

This product has been adjusted specifically for use in the region to which it was originally shipped. If operated outside the region to which it was originally shipped, the product may not perform as stated in the specifications.



User's Manual Version List

A handling description changes with versions of the software built in eClient. Please refer to below.

NOTE

- The version of software built in eClient can be checked with a [System]-[ICA] tab of [Terminal Properties].

OS: Microsoft Windows CE .NET

Software Manual	Microsoft Windows CE	Microsoft Windows Terminal Server	ICA Client Software
E (This manual)	4.10 Rev.2.7.1 or later	Version 7.2.0 or later	Version 7.23 or later
D	4.10 Rev.2.6.0 or later	Version 7.1.0 or later	Version 6.30 [Build1078B] or later
C	4.10 Rev.2.5.3 or later	Version 7.0.1 [Build0020] or later	Version 6.30 [Build1063B] or later
B	4.10 Rev.2.5.1 or later	Version 7.0.1 [Build0020] or later	Version 6.30 [Build1063B] or later
A	4.10 Rev.2.5.1 or later	Version 7.0.1 [Build0019] or later	Version 6.30 [Build1063] or later

NOTE OS: Microsoft Windows CE 2.12

Software Manual	Microsoft Windows CE	Microsoft Windows Terminal Server	ICA Client Software
D	2.12 Rev.1.62 or later	Version 6.53 or later	Version 6.20 [Build992] or later
C	2.12 Rev.1.58 or later	Version 6.51 or later	Version 6.20 [Build992] or later
B	2.12 Rev.1.50 or later	Version 6.28 or later	Version 6.20 [Build992] or later
A	2.12 Rev.1.29 or later	Version 6.28 or later	Version 6.00 [Build923] or later

SAFETY SYMBOLS

This manual uses the safety symbols below. They denote critical information. Please read them carefully.



WARNING

Failure to abide by the information in a WARNING may result in serious injury and can be life threatening.



CAUTION

Failure to abide by the information in a CAUTION may result in moderate injury and/or property or product damage.



Indicates a prohibited action.



Indicates to ground for safety.

Copyright© 2003-2004 EIZO NANA O CORPORATION. All rights reserved. No part of this manual may be reproduced, stored in a retrieval system, or transmitted, in any form or by any means, electronic, mechanical, or otherwise, without the prior written permission of EIZO NANA O CORPORATION.

EIZO NANA O CORPORATION is under no obligation to hold any submitted material or information confidential unless prior arrangements are made pursuant to EIZO NANA O CORPORATION's receipt of said information. Although every effort has been made to ensure that this manual provides up-to-date information, please note that EIZO monitor specifications are subject to change without notice.

ENERGY STAR is a U.S. registered mark.

Apple and Macintosh are registered trademarks of Apple Computer, Inc.

BSQUARE is a registered trademark of Microsoft Corporation.

DPMS is a trademark and VESA is a registered trademark of Video Electronics Standards Association.

JEM-CE is a trademark of BSQUARE Corporation.

VGA is a registered trademark of International Business Machines Corporation.

Windows is a registered trademark of Microsoft Corporation.

ScreenManager and PowerManager are trademarks of EIZO NANA O CORPORATION.

FlexScan and EIZO are registered trademarks of EIZO NANA O CORPORATION.



As an ENERGY STAR® Partner, EIZO NANA O CORPORATION has determined that this product meets the ENERGY STAR guidelines for energy efficiency.

TABLE OF CONTENTS

1. INTRODUCTION	5
1-1. General Description	5
1-2. Features	5
1-3. Package Contents.....	6
1-4. Controls & Connectors	7
2. CONNECTING THE eClient 630LT-GR/630LT-GR-N	9
2-1. Setting up the eClient 630LT-GR/630LT-GR-N	9
2-2. Connecting the eClient 630LT-GR/630LT-GR-N	9
3. SETTING UP the eClient 630LT-GR/630LT-GR-N	11
4. ADDING & CHANGING A CONNETION NAME	21
4-1. Adding a Connection Name.....	21
4-2. Setting an Autostart Connection.....	24
4-3. Modifying a Connection Name.....	24
5. LOGON & LOGOFF	25
5-1. Logon to a WTS / Logoff from a WTS.....	25
5-2. Opening/Closing a Local Web Browser.....	29
6. USING THE TERMINAL PROPERTIES	31
6-1. General	33
6-2. Local Resources (RDP protocol only)	34
6-3. Display.....	35
6-4. Experience (RDP protocol only)	37
6-5. Control Panel.....	38
6-6. ICA Settings (ICA Protocol only)	47
6-7. Server.....	48
6-8. Security	49
6-9. System.....	51
7. SOFTWARE UPDATING/INSTALLATION	52
8. PRACTICAL SETUP	56
8-1. 630LT-GR/630LT-GR-N settings	56
8-2. Short cut command by keyboard	60
9. TROUBLESHOOTING	61
10. CLEANING	63
11. SPECIFICATIONS	65
12. REFERENCE	67
12-1. Attaching an Arm Stand	67
INDEX	68

1. INTRODUCTION

Thank you very much for purchasing the EIZO eClient 630LT-GR/630LT-GR-N.

1-1. General Description

The eClient 630LT-GR/630LT-GR-N connects with a Windows Terminal Server*, which installed Microsoft Windows NT Server 4.0 Terminal Server Edition or Windows 2000 Server/Advanced Server/Datacenter Server, and this product is used as a terminal using them.

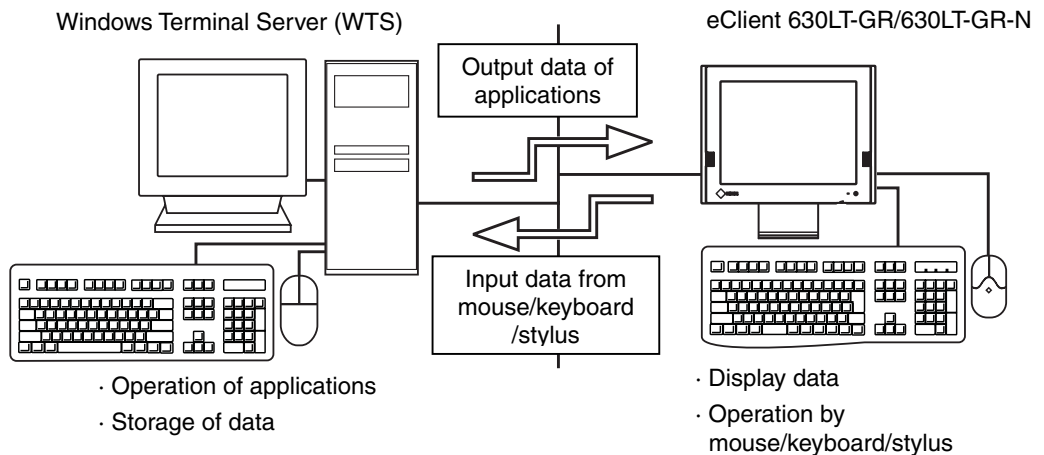

- * Windows Terminal Server expresses 'WTS' hereafter.

1-2. Features

- Lower TCO (Total Cost of Ownership)
- Saves Space and Power Consumption
- Less Heat, Less Noise
- Speakers equipped
- Serial Port for Modem/PDA
- Local Web Browser added as a default connection 630LT-GR/630LT-GR-N
- PC card slot for modem card, LAN card, and wireless LAN card
- Wake on LAN supported
- A Touch Panel and a Stylus Provided

1-3. Package Contents

Please make sure that all the items listed are in the package. Please contact your local dealer for assistance if any of the listed items are missing or damaged.

- eClient 630LT-GR/630LT-GR-N
- Mouse (FDM-310)
- Power Cord
- Screw (M4 x 12 mm) x 4
- User's Manual (includes Limited Warranty)
- 2 Stickers of the Brightness Control Guide
- Stylus

NOTE

- A keyboard is not included. Please purchase it separately.
Please use the enclosed mouse. EIZO NANA O CORPORATION will not be held responsible for accident or damage caused by the use of a mouse manufactured by other companies.
- Please retain the packing materials for future transference.
- Brightness can be adjusted by using key combinations on the keyboard (see page 36). Key combinations for an adjustment are presented on the stickers. Please apply them for your convenience.

1-4. Controls & Connectors

Front

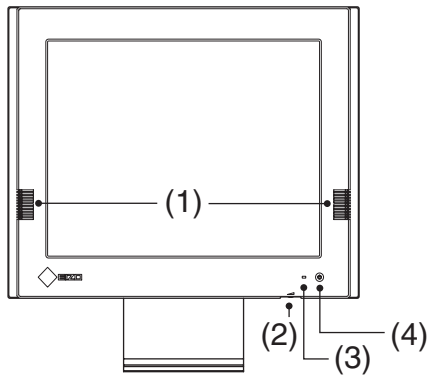

- (1) Power button
- (2) Power Indicator

Color	630LT-GR/630LT-GR-N status
Green	<ul style="list-style-type: none">• Operation• Screen saver mode
Yellow	Power save mode
Off	<ul style="list-style-type: none">• Power off (Wake on LAN standby)

- (3) Speakers
- (4) Volume Control

NOTE

- When turning off/on the unit, leave the unit off for a few seconds before turning it on again.

Rear

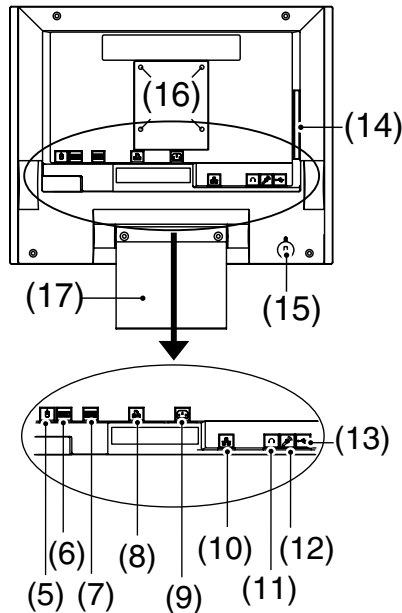

- (5) Mouse Connector
- (6) Keyboard Connector
- (7) Serial Port (RS-232C)
- (8) Parallel Connector
- (9) Power Connector
- (10) Ethernet Connector (10 Base-T, 100 Base-TX)
- (11) Headphone Connector
- (12) Microphone Connector
- (13) USB Port (Downstream) x 2
- (14) PC Card Slot
- (15) Security Lock*¹
- (16) Holes for Mounting an Arm Stand*²
- (17) Stand (Detachable)

*¹ This allows for connection of a security cable. This lock supports Kensington's MicroSaver security system. For further information, please consult:

Kensington Technology Group
2855 Campus Drive, San Mateo, CA 94403 USA
Tel: 800-650-4242, x3348
Intl: 650-572-2700 Fax: 650-572-9675
<http://www.kensington.com>

*² The LCD monitor can be used with an optional arm stand by removing the stand (See p.67).

2. CONNECTING THE eClient 630LT-GR/630LT-GR-N

This chapter explains how to connect the eClient 630LT-GR/630LT-GR-N to a WTS.

2-1. Setting up the eClient 630LT-GR/630LT-GR-N

Please observe the following cautions when connecting the 630LT-GR/630LT-GR-N.

WARNING

Place the eClient 630LT-GR/630LT-GR-N on a strong, stable surface.

A unit placed on an inadequate surface may fall, resulting in injury or equipment damage. If the unit falls, disconnect the power immediately and have the unit checked by a qualified service engineer before using it again. Using a unit after it has been dropped may result in fire or electric shock.

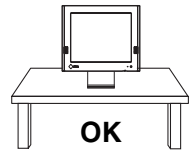

Set the unit in an appropriate location.

Not doing so may result in fire, electric shock, or equipment damage.

- * Do not place outdoors.
- * Do not place in the transportation system (ship, aircraft, trains, automobiles, etc.)
- * Do not place in a dusty or humid environment.
- * Do not place in a location where the steam comes directly on the screen.
- * Do not place near heat generating devices or a humidifier.



2-2. Connecting the eClient 630LT-GR/630LT-GR-N

NOTE

- Before connecting the eClient 630LT-GR/630LT-GR-N, confirm the following:
 - The eClient 630LT-GR/630LT-GR-N is turned off.
 - The WTS is turned on.
- Connect the peripherals to the appropriate connectors of the unit.

-
1. In case of connecting the WTS through LAN:
Connect the eClient 630LT-GR/630LT-GR-N to the network with an Ethernet cable.

In case of a dial-up or dial-in connection:
Connect the eClient 630LT-GR/630LT-GR-N to a modem or a modem card.

NOTE

- Please remove the lid on the side of the 630LT-GR/630LT-GR-N before connecting a LAN card or a modem card.

2. Plug a keyboard and a mouse into the eClient 630LT-GR/630LT-GR-N. If using other devices, please connect them to the appropriate connectors.

In use of a stylus or a finger as an input device, it is not necessary to connect a mouse.

3. If using other devices, please connect them to the appropriate connectors.

4. Plug the power cord into the power connector.

 **WARNING**

Use the enclosed power cord and connect to the standard power outlet of your country.

Be sure to remain within the rated voltage of the power cord.
Not doing so may result in fire or electric shock.

The equipment must be connected to a grounded main outlet.

Not doing so may result in fire or electric shock.



3. SETTING UP the eClient 630LT-GR/630LT-GR-N

This chapter presents how to prepare for a connection with a WTS when the eClient 630LT-GR/630LT-GR-N starts up for the first time.

1. Turn on the eClient 630LT-GR/630LT-GR-N.

The power indicator turns green and a picture appears on the screen.

NOTE

- When no picture is displayed, or when the message (No keyboard connected. / No mouse connected.) is shown on the screen, please refer to “8. Troubleshooting” on page 61. (In use of a stylus or a finger as an input device, “No Mouse Connected!!” caution does not effect our operation.)

2. “Touch panel calibration” is displayed.

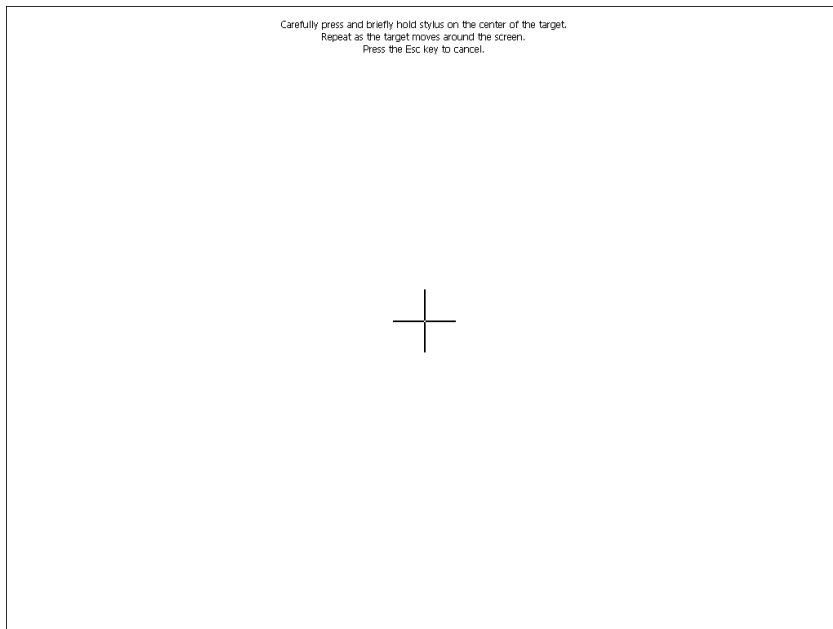

Five targets are displayed on the screen. Press the targets with a stylus or a fingertip to locate the center of the touch panel. If you accidentally touched the screen in the wrong spot during calibration, you will distort the touch panel calibration.

3. “Calibration measured” window is displayed when you finished.

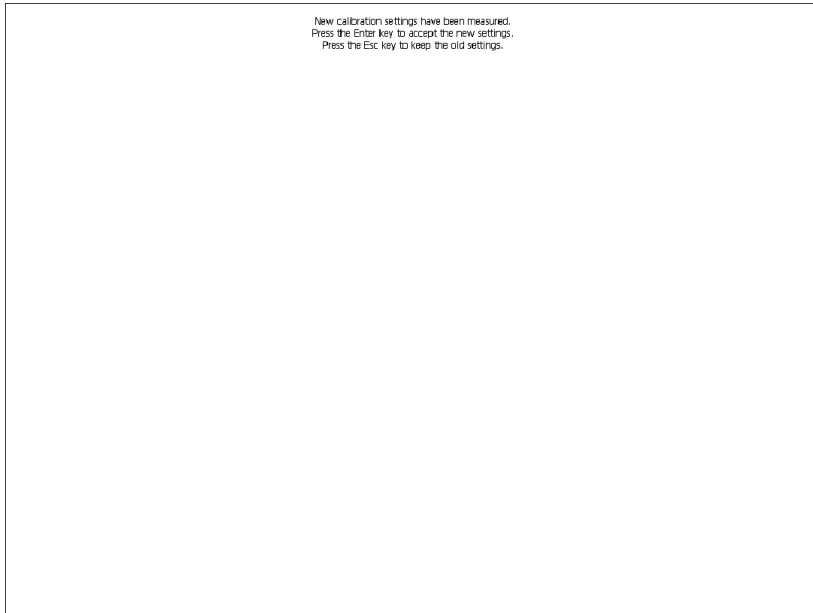

Click the “Enter” key to accept the settings.

4. “eClient Setup Wizard” is displayed.

(Set up the 630LT-GR/630LT-GR-N according to directions of the displayed dialog box.)

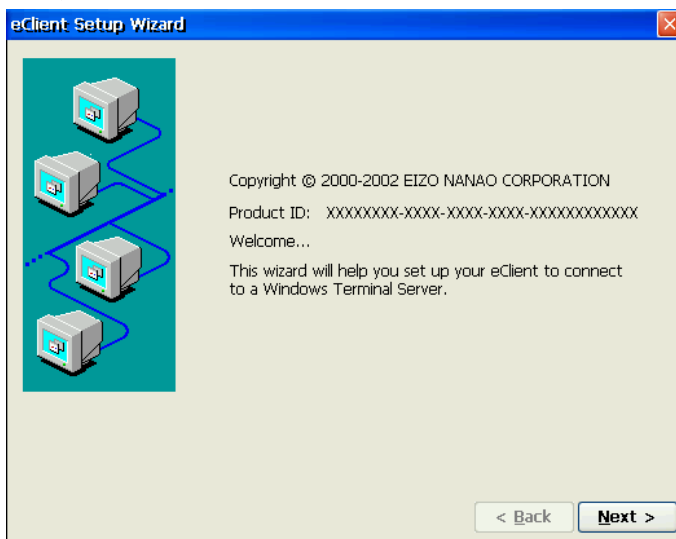

5. End User License Agreement page is displayed.

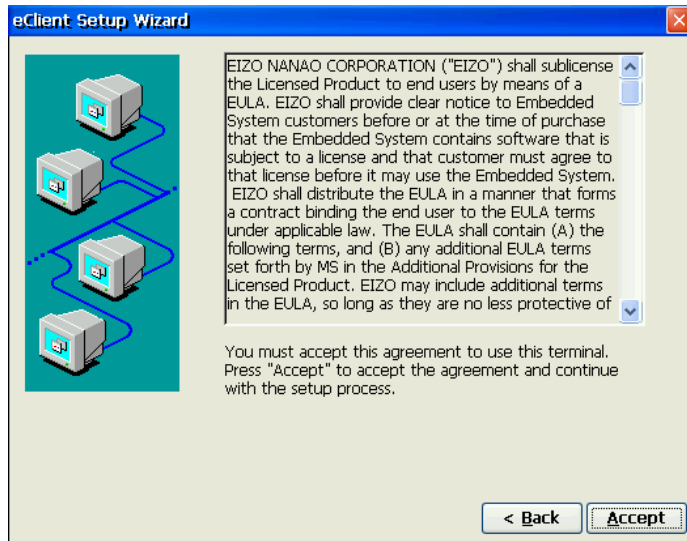

Read the content and click [Accept] to continue.

6. Set up the network environment.

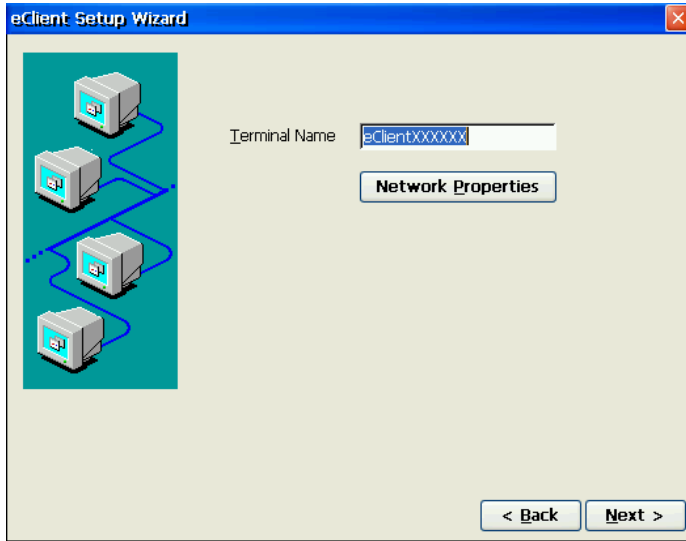

[Terminal Name]Type the name to identify this unit on the network.

Click [Network Properties] and set up connection information according to the connection method to WTS/Web server.

Connection method	Reference page
<ul style="list-style-type: none"> In case of connecting the WTS/Web through Built-in LAN 	p.15
<ul style="list-style-type: none"> In case of connecting with a NE2000 compatible LAN card: 	p.15
<ul style="list-style-type: none"> In case of connecting with a Cisco wireless LAN card/ Agere wireless LAN card: 	p.16
<ul style="list-style-type: none"> In case of a dial-up connection: 	p.17
<ul style="list-style-type: none"> In case of the dial-in connection (ICA protocol only) to log on to WTS 	Go to step 7 * Skip the [Network Properties] settings

NOTE

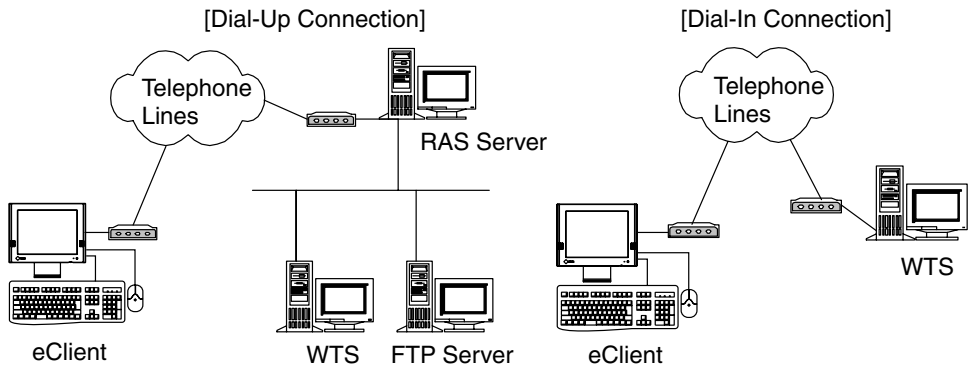

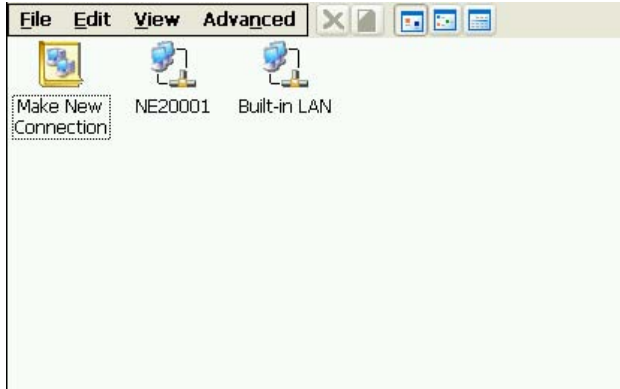

Example;
In case of connecting with a
NE2000 compatible LAN card

In case of connecting the WTS/Web through Built-in LAN:

- (1) Double-click [Built-in LAN] icon.



- [IP Address] Type the IP address of the unit.
- [Name Servers] Type the IP address of each server when DNS or WINS is used.
- [Advanced]..... Type the transmission speed and MAC Address of a network.

In case of connecting with a NE2000 compatible LAN card:

- (1) Double-click [NE 20001] icon.

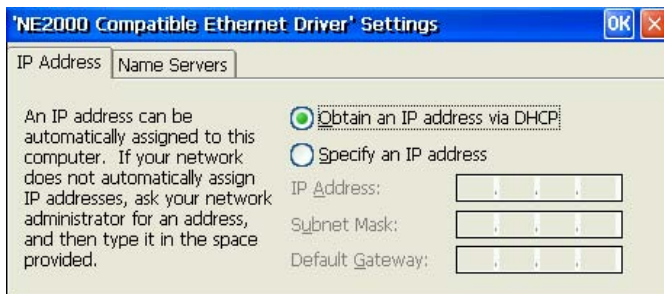

- [IP Address] Type the IP address of the unit.
- [Name Servers] Type the IP address of each server when DNS or WINS is used.

In case of connecting with a Cisco wireless LAN card/Agere wireless LAN card:

(1) Double-click [CISCO1]/[WLAGS461] icon.

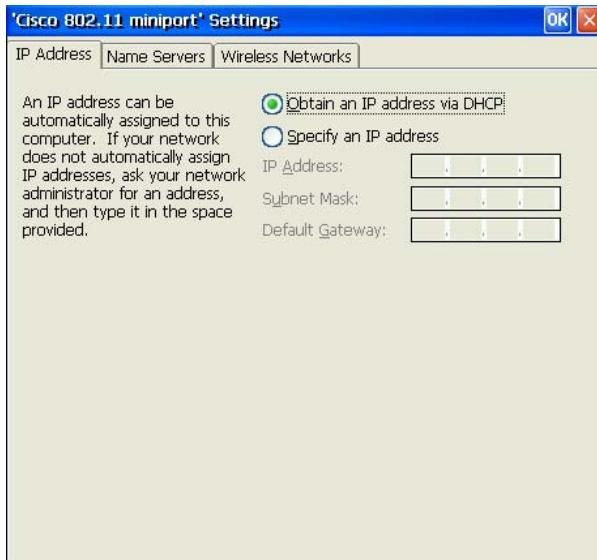

[IP Address]Type the IP address of the unit.

[Name Servers].....Type the IP address of each server when DNS or WINS is used.

[Wireless Networks]

.....Set the connection setting with a wireless LAN card.

NOTE

- In case of selecting [Obtain an IP address via DHCP], deactivate the built-in LAN by the procedure below.
 - (1) Double-click [Built-in LAN] icon
 - (2) Select [Specify an IP address] of [IP Address] tab, type “255.255.255.255” in the [IP Address] box.

In case of a dial-up connection:

- (1) Double-click [Make New Connection] icon.
- (2) Type a name for the connection and select the connection type (Dial-Up Connection).
- (3) Select a model, set up the TCP/IP settings and Security settings.
- (4) Type the phone number for the connection.
- (5) In case of a dial-up connection, the information of local location needs to be set up. Set up the information in the later procedure 8.

NOTE

- In using the following case, set up in addition to the WTS/Web server information settings.
 - When you use VPN (Virtual Private Network)
 - (1) Double-click [Make New Connection] icon.
 - (2) Type a name for the connection and select [Virtual Private Network].
 - (3) Type host name or IP address and set up the TCP/IP settings and Security settings.
 - When you use ADSL
 - (1) Double-click [Make New Connection] icon.
 - (2) Type a name for the connection and select [PPP over Ethernet [PPPoE]].
 - (3) Type PPPoE service name (or blank for any service) and set up the TCP/IP settings and Security settings.
 - Set up a Remote Connection
- By setting up a Remote Connection, the WTS/Web server can be connected easily.
- (1) Double-click [Make New Connection] icon.
 - (2) Type a name for the connection and select [Remote Connection Setup].
 - (3) Select the desired connection from the [Available Connections] list and click [Add] button to set in the [Current Connections]. (Connections listed in the [Current Connections] will be executed with the listed order.)
 - (4) Select the [Make default connection] check box.

A small window will be displayed on the right bottom of the screen.



Clicking an active button of the small window starts the connection listed in the [Current Connections].

To set an automatically start connection when the eClient 630LT-GR/630LT-GR-N boots up, select the [Connect automatically on boot up] check box.

7. Set up the desktop area.

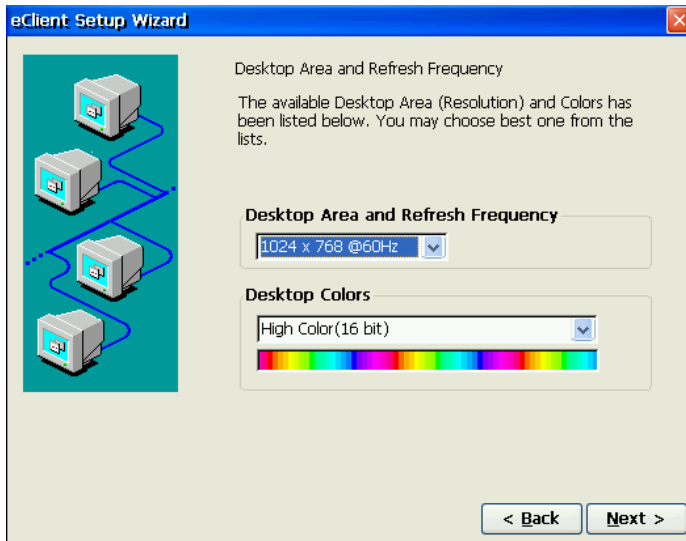

[Desktop Area and Refresh Frequency]

.....Set the resolution/refresh rate. (630LT-GR/630LT-GR-N supports 1024 x 768 @60 Hz only).

[Desktop Colors].....Set the desktop color (256 Colors / High color) of the following.

- Windows CE desktop (before WTS connection)
- Windows desktop (after a WTS connection with RDP protocol)

NOTE

- [High Color] setting after WTS connection can be available only when connecting with WTS, which version is 5.1 or later.
- After WTS connection, the WTS setting may control the desktop color.

8. Set up the browser connection.

Set up if you are setting up a web browser connection.

(1) Select [Internet Options] icon and click [Open].

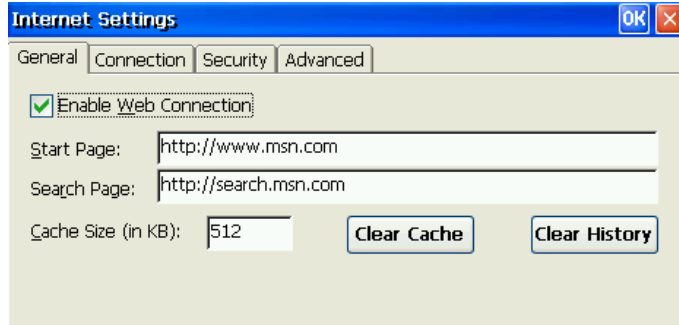

[General].....Set up the browser.

[Connection].....Set up the connection method to the browser.

[Security].....Set up the security for the connection to the browser.

[Advanced].....Set up the display method of the browser.

9. Set up the printer.

Set up if you are using a local printer.

NOTE

- The following is required to install a local printer.
 - A printer is connected to the serial connector, the parallel connector or a USB port.
 - An RDP protocol is used for connection to a WTS.
 - Microsoft Windows 2000 Server / Advanced Server / Datacenter Server is installed in a WTS.

(1) Select [Printer] icon and click [Open] icon.

(2) Select [Add printer] icon and click [Open] icon.

(3) “WTB Printer Wizard” is displayed (Follow the direction of the dialog box.).

1. Select a printer port.
(Select “COM 1” for connecting to the serial connector, “LPTx” for the parallel connector or the USB port.)
2. Select a model of your printer.
3. Name your printer.

10. Setup the Local sender's setting

Setup if you are connecting to WTS/Web server by dial-up connection.

(1) Select [Dialing] icon and click [Open] icon.

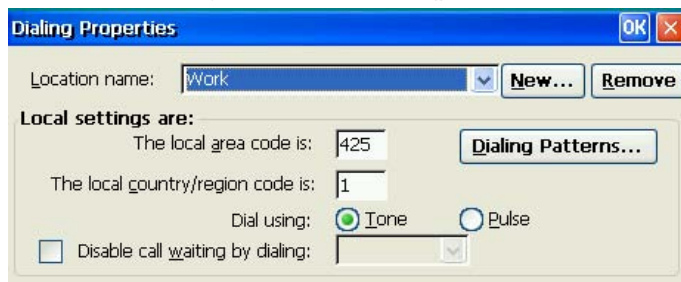

[Location name].....Choose the sender's location (click [New] to add a new sender's location).

[Local Settings are:].....Setup the local settings.

11. The last page of the “eClient Setup Wizard” is displayed.



Click [Finish].

Click [Yes] if a “Terminal Settings change” dialog box is displayed.

The “Terminal Connection Manager” dialog box will be displayed after restarting.

NOTE

- Click [No] to finish the “eClient Setup Wizard” and display “Terminal Connection Manager” on the screen. The setting is not activated until the 630LT-GR/630LT-GR-N is restarted.

4. ADDING & CHANGING A CONNECTION NAME

This chapter shows how to add, delete, and modify connection names to a WTS. All the settings are managed in the “Terminal Connection Manager”.

4-1. Adding a Connection Name

These are settings for the server connection.

Each protocol has different settings. Please install the appropriate settings.

- In use of the Microsoft Remote Desktop Client (RDP) page 22
- In use of the Citrix ICA Client (ICA) page 23

NOTE

- Please install Citrix MetaFrame server into the Server when using the ICA protocol.

In Use of RDP Protocol

1. Display [Terminal Connection Manager].

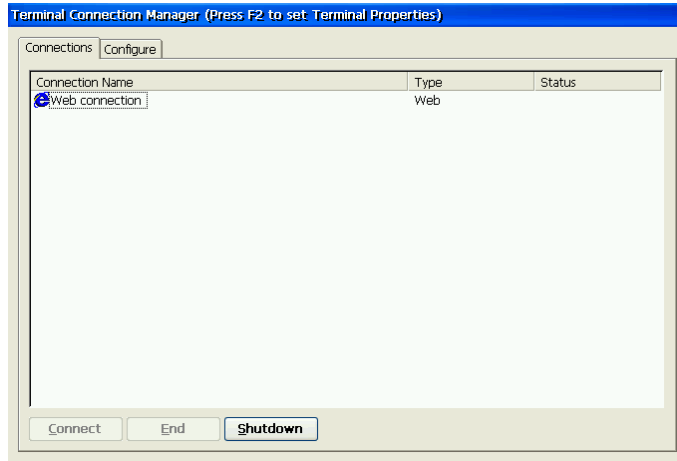

Click the [Configure] tab and [Add...] to set the connection information of the WTS.

2. Protocol selection dialog box is displayed.

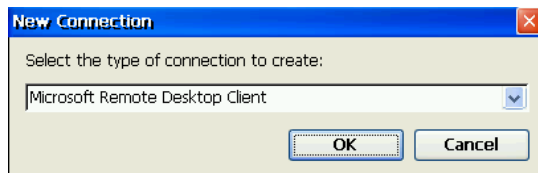

Select the “Microsoft Remote Desktop Client” (RDP).

3. “WTS Connection Wizard” is displayed. (Setup as following the wizard.)

- (1) Type the connection name and the name of the Server.
- (2) Setup to enable an Automatic Logon to the WTS after connecting if you want.
- (3) Select whether to display the Windows desktop screen or start up an application.

Clicking [Finish] to return to the “Terminal Connection Manager” dialog box, the registered connection name is displayed in the [Connection Name].

NOTE

- Please repeat step 2 to 3 to entry more than two kinds of connections.

In Use of the ICA protocol

1. Display [Terminal Connection Manager].

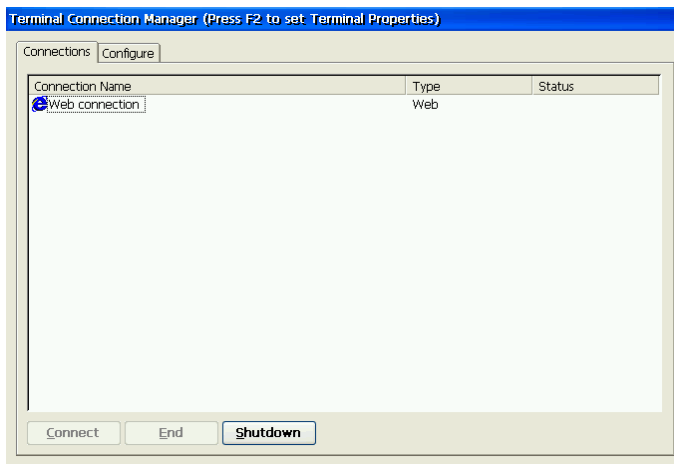

Click the [Configure] tab and [Add...] to set the connection information of the WTS.

2. “New Connection” dialog box is displayed on the screen.

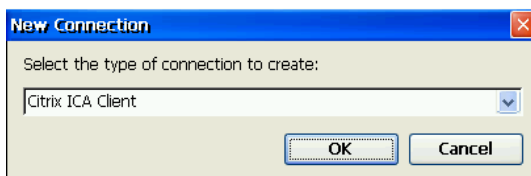

Select the “Citrix ICA Client” (ICA).

3. “Specify Connection Type” is displayed. (Setup as following the wizard.)

- (1) Choose a connection type (Network Connection / Dial-In) for the remote application.
- (2) Setup a server or modem according to a connection type.
- (3) Type a connection name of the WTS.
- (4) Select whether to display the Windows desktop screen or start up an application.
- (5) Setup to enable an Automatic Logon to the WTS after connecting if you want.
- (6) Set the desktop color of the Windows desktop after WTS connection.
- (7) Setup the compression, encryption and sound.
- (8) Setup the firewalls settings.

Clicking [Finish] to return to the “Terminal Connection Manager” dialog box, the registered connection name is displayed in the [Connection Name].

NOTE

- Please repeat the step 2 to 3 when you adding another connection name.

4-2. Setting an Autostart Connection

This function configures a connection to start automatically each time the eClient 630LT-GR/630LT-GR-N is turned on. (This function is available for a LAN connection.) Select the desired connection name for Autostart Connection and click [Startup...].

[Make the selected connection your Default connection.]

.....This makes the selected connection name your default connection.

[Automatically start the selected connection at startup.]

.....This makes the selected connection to start automatically each time the eClient 630LT-GR/630LT-GR-N is turned on. The setting is effective from the next startup.

NOTE

- To connect to the default WTS connection set in the “Terminal Connection Manager” dialog box, press [Ctrl] + [Alt] + [Home] keys.

4-3. Modifying a Connection Name

Deleting a Connection

Select the connection name you want to delete, click [Delete].

Editing a Connection

Select the connection name you want to modify, click [Edit...]. [Edit Connection] dialog box or [Edit Connection Details] is displayed, edit the settings according to a connection protocol.

5. LOGON & LOGOFF

This chapter shows how to log on to and log off from a WTS.

5-1. Logon to a WTS / Logoff from a WTS

Logon to a WTS

1. Follow the direction from (1) to (3), depending on the environment of the eClient 630LT-GR/630LT-GR-N.

- (1) To connect and log on to a WTS through local network:

Go to step 2.

- (2) To connect and log on to a WTS with dial-up connection:

Click an active button of a small window on the right bottom of the screen.



Clicking the button makes a dial-up connection.

Check the clock's running, and go to step 2.

- (3) To connect and log on to a WTS with dial-in connection:

Go to step 2.

2. Select the desired connection name from the [Connection] tab of “Terminal Connection Manager”, click the [Connect] (or simply double click the connection name.)

3. The eClient 630LT-GR/630LT-GR-N connects to the WTS and the “Log On to Windows” dialog box is displayed. Type your [User name] and [Password], and click [OK] to log on to the WTS.

After logon, the 630LT-GR/630LT-GR-N allows you to use Microsoft Windows applications running on the WTS.

Multi Session

You can log on to the WTS with the several connection names, and switch the active sessions.

1. Logon with a Connection Name, as following the previous steps.
2. Press [Ctrl] + [Alt] + [End] keys after logon.
3. “Terminal Connection Manager” is displayed. Select another Connection Name to log on to, and click [Connect]. (Or double click the connection name.)

Repeat the step 2 to 3 to log on to another connection name.

Switching the Active Session of the WTS

Press [Ctrl] + [Alt] + [UP ARROW] key / [DOWN ARROW] key to switch the active session.

NOTE

- The multi session is not available on a dial-in connection.

Logoff from the WTS

If your eClient 630LT-GR/630LT-GR-N starts its operation with a desktop

1. Logoff from the WTS.

- (1) Close all applications.
- (2) Select [Start] on the taskbar.
- (3) Microsoft Windows NT Server 4.0 Terminal Server Edition:
Select [Logoff].
Microsoft Windows 2000 Server / Advanced Server / Datacenter Server:
Select [Shut Down...] and select [Logoff] of the [Shut Down Windows] dialog box.

- (4) Click [OK] on the Logoff Window.

The session ends and automatically logs off from the WTS. The “Terminal Connection Manager” dialog box is displayed.

If a dial-up connection is running, click the active button of the window on the right of the screen.



Clicking the button disconnects the dial-up connection.

2. Shut down the eClient 630LT-GR/630LT-GR-N.

There are three ways to shut down the unit.

- Click [Shutdown] in the “Terminal Properties” dialog box (or press the power button). “eClient Shut down” dialog box is displayed, select [Shutdown] and click [OK].
- Press the power button. “eClient Shut down” dialog box is displayed. Press the power button again.
- Press the power button and leave the unit for 20 seconds. The unit automatically shuts down.

If your eClient 630LT-GR/630LT-GR-N starts its operation with an application

1. Log off from the WTS.

Close applications to log off from the WTS.

“Terminal Connection Manager” is displayed.

If a dial-up connection is running, click the active button of the window on the right bottom of the screen.



Clicking the button disconnects the dial-up connection.

2. Shut down the eClient 630LT-GR/630LT-GR-N.

(Please refer to the previous page for shutting down the eClient 630LT-GR/630LT-GR-N.)

NOTE

- It is possible to disconnect from a WTS without closing applications in use (or without logging off). The last view of the application is displayed when the next connection to the WTS is made.

5-2. Opening/Closing a Local Web Browser

Opening a Local Web Browser

1. Please follow the directions relevant on the environment of the eClient 630LT-GR/630LT-GR-N.

(1) If the web server is on the same network (Intranet):

Go to step 2.

(2) If the web server is not on the same network, and a dial-up connection is needed (Internet):

Click an active button of a small window on the right bottom of the screen.



Clicking the button makes a dial-up connection. Check the clock's running, and go to step 2.

2. Select the [Web connection] from the [Connections] tab and click [Connect] (or simply double click the [Web connection]).

3. The local web browser opens.

It is possible to browse web pages on the Internet.

NOTE

- It is possible to switch between each session (Web pages and "Terminal Connection Manager") by pressing [Ctrl] + [Alt] + [End] keys.

Closing a Local Web Browser

1. Close the local web browser.

Select [Close] under the [File] on the menu bar and close the local web browser.

Return to the “Terminal Connection Manager” dialog box.

If a dial-up connection is being made, click the active button of the window on the right of the screen.



Clicking the button disconnects the dial-up connection.

2. Shut down the eClient 630LT-GR/630LT-GR-N.

There are three ways to shut down the unit.

- Click [Shutdown] in the “Terminal Properties” dialog box (or press the power button). “eClient Shut down” dialog box is displayed, select [Shutdown] and click [OK].
- Press the power button. “Shut down the eClient” dialog box is displayed. Press the power button again.
- Press the power button and leave the unit for 20 seconds. The unit automatically shuts down.

NOTE

- It is possible to disconnect from a local web server by turn the eClient 630LT-GR/630LT-GR-N off.

6. USING THE TERMINAL PROPERTIES

This chapter presents how to modify all settings of the eClient 630LT-GR/630LT-GR-N using the “Terminal Properties”.

To display the “Terminal Properties” during logging on, press F2 in the “Terminal Connection Manager” dialog box.

Settings and adjustments of “Terminal Properties”

Tab name	Contents	Remarks	Refer to
General	Product information, Terminal Name	Display the Product information	p.33
	Reset	Reset the terminal to factory-default settings	
Local Resources ¹	Remote computer sound	Sound output after WTS connection	p.34
	Local devices	Local devices reference after WTS connection	
Display	Desktop Area and Refresh Frequency	Resolution and refresh rate of Desktop Area	p.35
		Portrait display (ON/OFF)	
	Desktop Colors	Colors of Desktop Area (Windows CE/ Windows Desktop after WTS connection ¹)	p.35
	Screen Saver	Power Save	p.36
	Contrast / Brightness	Brightness adjustment	p.36
Experience ¹	Connection speed		p.37
Control Panel	Dialing	Dial Properties (Local Settings)	p.38
	Keyboard	Keyboard settings	p.39
	Password	Password Settings	p.39
	Mouse	Mouse Settings	p.40
	Stylus	Touch Panel Properties	p.40
	Volume & Sounds	Volume settings & Sounds selection	p.40
	Date/Time	Date / Time / Time Zone	p.42
	Certificates	Certification list and import	p.43
	DHCP Settings	DHCP Server settings	p.43
	Add-on	List and remove Installed software	p.44
	Internet Options	Internet Settings	p.44
	Printers ¹	Local printer settings	p.45
	Network & Dial-up connection	Installed network and dial-up connection	p.46
ICA ²	ICA Client software		p.47
	ICA Client Configuration		
	ICA Client Feature Settings		
Server	FTP Service	FTP server settings	p.48
Security	Terminal Security	Terminal Security (ON/OFF)	p.49
	Network Administrator	Administrator Console IP address	p.50
System	Software	Windows CE Version, Terminal server Client version/build, Boot software version/build, Update	p.51
	Hardware	Serial Number	
	Network	Network settings information	

¹ Applicable only for RDP

² Applicable only for ICA

6-1. General

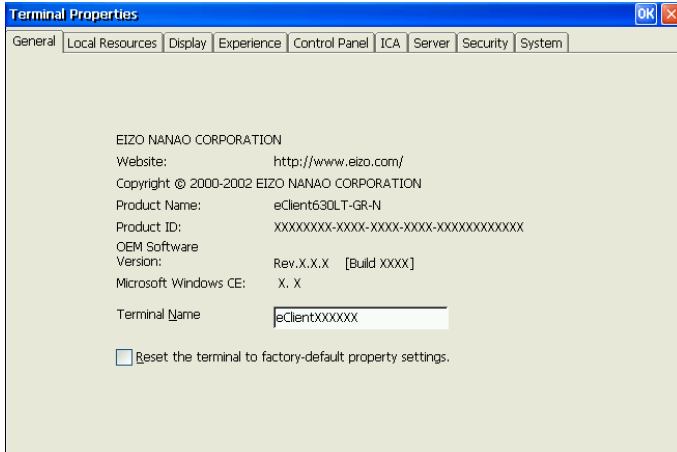

Product Information

[General] tab shows the product name, Product ID, Windows CE Revision, version, and Terminal name.

Resetting to Default

- (1) Select the [Reset the terminal to factory-default property settings] check box.
- (2) The “System Settings Change” dialog box is displayed, click [Yes].
- (3) “Terminal Properties” is displayed.

Click [OK].

Confirmation window is displayed, click [Yes] to restart the terminal. “eClient Setup Wizard” will be displayed after restarting the terminal.

6-2. Local Resources (RDP protocol only)

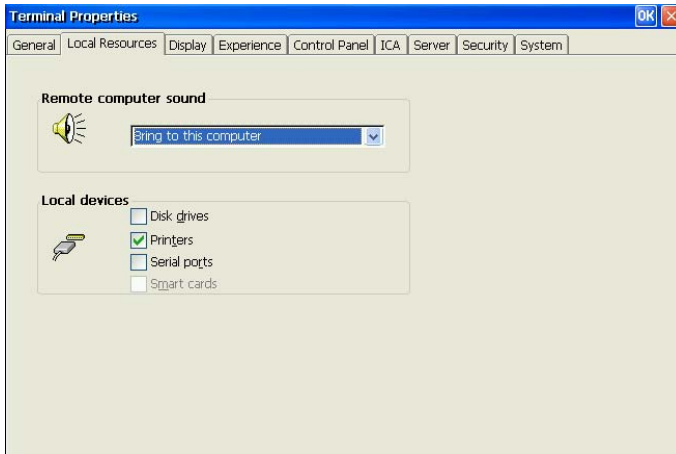

Sound settings

[Remote computer sound]...Sound settings after WTS connection (Remote computer means WTS).

Device settings

[Local devices]Select the applicable device check box when using the device connected from the WTS after WTS connection.

NOTE

- Sound settings and [Disk drives], [Serial ports] of Local devices can be available only when connecting with WTS, which version is 5.1 or later.

6-3. Display



Resolutions / Desktop Colors

[Desktop Area and Refresh Frequency]

.....Set the resolution/refresh rate. (630LT-GR/630LT-GR-N supports 1024 x 768 @60 Hz only).

[Colors].....Set the desktop color (256 Colors / High color) of the following.

- Windows CE desktop (before WTS connection)
- Windows desktop (after a WTS connection with RDP protocol)

NOTE

- [High Color] setting after WTS connection can be available only when connecting with WTS, which version is 5.1 or later.
- After WTS connection, the WTS setting may control the desktop color.

Power save

[Screen Saver].....Set the screen saver and power save settings. Select the check box, and set an idle period into the [Wait] box.

NOTE

- Power saving system
After the Screen Saver idle period passed, eClient shift to the power save mode. The power consumption is lower than 7 W in the power save mode.
- Do your part to conserve energy, turn off the unit when you are finished using it. Complete energy use can only be accomplished by disconnecting the unit's power supply cord from the plug receptacle.

Brightness

[Contrast/Brightness]

[Settings]Enables to adjust the brightness of the screen.
Selecting the [Enable Contrast/Brightness control from Keyboard] check box enables to adjust the brightness/contrast from a Keyboard.

- [Alt] key and [+] key: The brightness of the screen increases.
- [Alt] key and [-] key: The brightness of the screen decreases.

6-4. Experience (RDP protocol only)

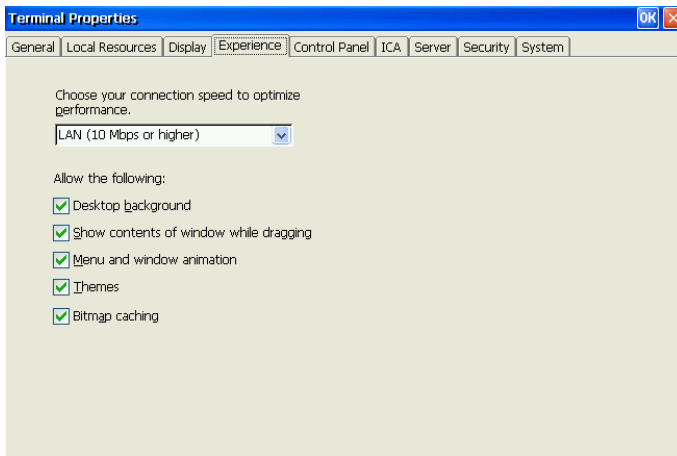

Connection speed

Specify your connection speed to WTS connection.

Choose your connection speed from the pull-down menu or select the setting check box.

NOTE

- This setting can be available only when connecting with WTS, which version is 5.1 or later.

6-5. Control Panel



Dialing

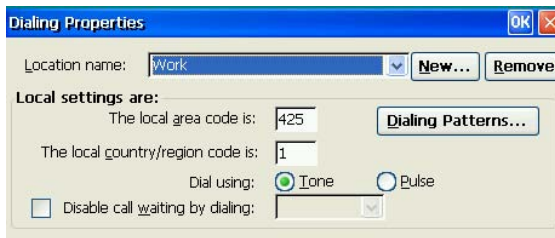

[Location name].....Choose the sender's location (click [New] to add a new sender's location).

[Local Settings are:].....Setup the local settings.



Keyboard

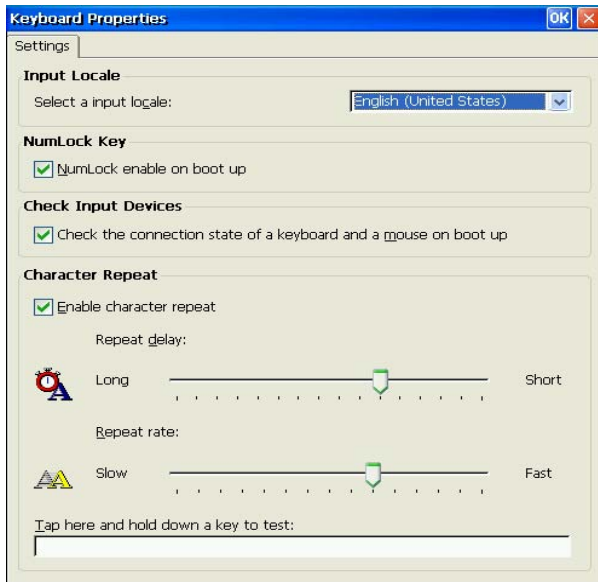

[Input Locale] Selects a keyboard language.

[NumLock Key] Enables/cancels NumLock function on start-up.

[Check Input Devices] Enables/cancels checking the connection state of a keyboard and a mouse on start-up. When a keyboard and/or mouse are not connected on start-up, the error message is displayed. When you use neither a mouse nor a keyboard intentionally and you do not display an error message on start-up, uncheck this function.

[Character Repeat] Allows adjusting the speed at which a character repeats when hold down a key.



Password

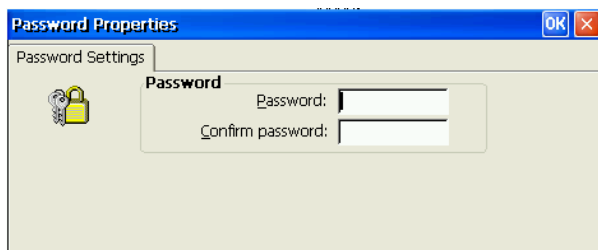

[Password] This enables password settings on FTP service (p.48) and Security functions (p.49).



Mouse

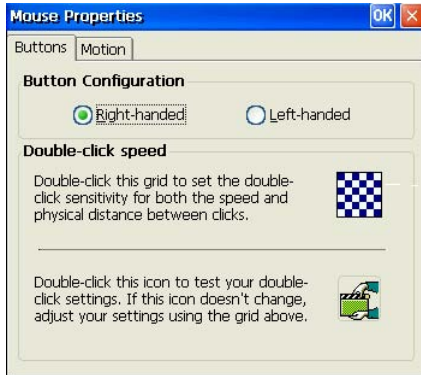

- [Buttons]Assigns the primary mouse button and the secondary mouse button.
- [Motion]Adjusts the speed at which the pointer moves on your screen and how fast the mouse pointer accelerates as you move the mouse.



Touch Panel Properties

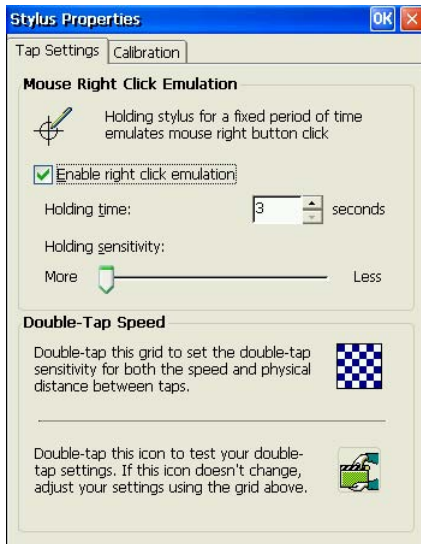

- [Tap Settings].....Set the mouse right click emulation and adjust right click emulation.
- [Holding time] means the holding stylus.
- [Holding sensitivity] means the sensitivity to recognize the stylus holding status. For example, when setting the [Holding sensitivity] to “LESS”, stylus is recognized to be stable even the stylus holding position slides a little.
- [Calibration].....This enables to recalibrate the touch panel.

NOTE

- Changing the Double-click speed, and Double-click width and height
When you have difficulty with double-clicking on the touch panel with a stylus (or a fingertip):

[Double-click speed]

- 1) Click Window's [Start] and select [Settings] - [Control Panel].
- 2) Double-click [Mouse] and adjust the speed at [Double-click speed].

[Double-click width and height]

- 1) Click Window's [Start] and select [Run...].
- 2) Type 'RegEdit.exe' on [Name] and click [OK].
- 3) [Registry Editor] is displayed. Select [HKEY_CURRENT_USER] - [Control Panel] - [Mouse].
- 4) Double-click [DoubleClickHeight] and [DoubleClickWidth] and change the settings on [Value Data]. (Height and width will be increase as the value increase.)
- 5) Close [Registry Editor].
- 6) Logoff from the Server and re-logon to confirm the settings are effective. (If you do not logon to the Server after changing the settings, the change will not be effective.)



Volume & Sounds



[Volume]Select the check boxes to enable sounds for events, applications, and notifications.

[Sounds]Select sounds for each case.



Date / Time

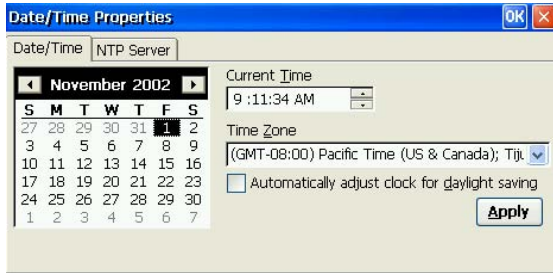

NOTE

- Date and time will return to the default settings if the power cord is unplugged.

[Date/Time]Set date, current time, or time zone.

[NTP Server]Synchronize time with the NTP Server.

Select when to synchronize time with the NTP server
(on every boot up or every time clicking the
[Synchronize] button.)

NOTE

- Synchronizing time at startup is effective when the 630LT-GR/630LT-GR-N is connecting WTS/Web Server using a Built-in LAN connection or connection with a LAN card.
- Getting the NTP Server information from the DHCP Server needs to satisfy the following:
 - * Connect the WTS/Web Server by using a Built-in LAN connection or connection with a LAN card
 - * Use the DHCP Server to get information such as IP address
 - * Set the NTP Server option at the DHCP Server.



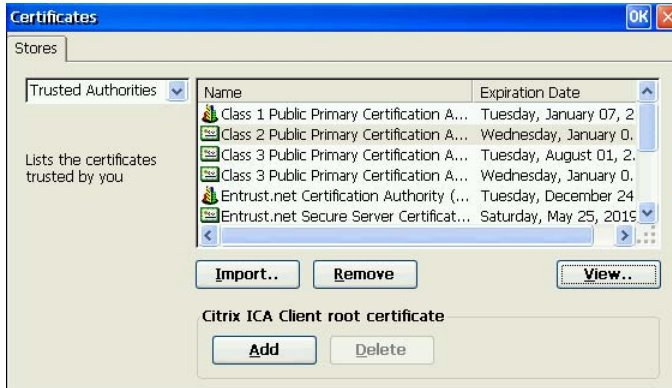

Certificates



Lists the certificates stored in the 630LT-GR/630LT-GR-N. A certificate can be registered, if an external disk is connected to this product, a certificate file can be imported.

NOTE

- When using the Secure Gateway, select its certificate and click [Add]. By clicking the button, the certificate can be used. (The certificate's icon changes from  to .)



DHCP Settings

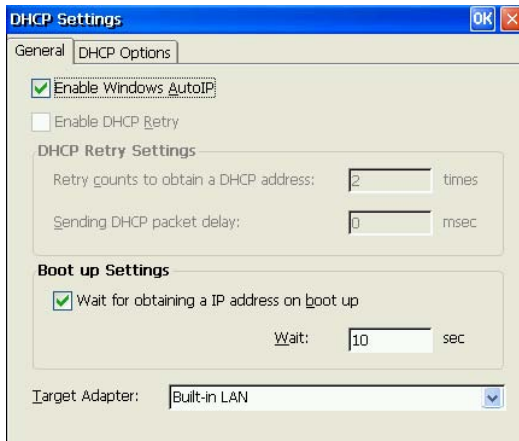

[General]This allows the user to receive IP information from a DHCP server.

[DHCP Options]Select the [Enable DHCP Options] check box to receive essential information about the 630LT-GR/630LT-GR-N from the DHCP server every time the 630LT-GR/630LT-GR-N is turned on. Refer to “Practical Setup” on page 56 for details.



Add-on

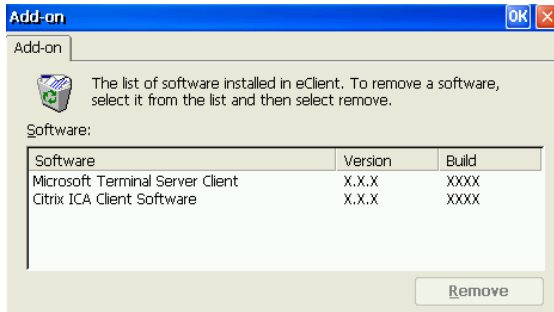

Add-on lists all application software installed in eClient. To remove software, select it and click [Remove].

NOTE

- Neither Microsoft Terminal Server Client nor Citrix ICA Client Software is removed.



Internet Options



[General]Setup the browser.
[Connection]Setup the connection method to the browser.
[Security]Setup the security for the connection to the browser.
[Advanced]Setup the display method for the browser.



Printers

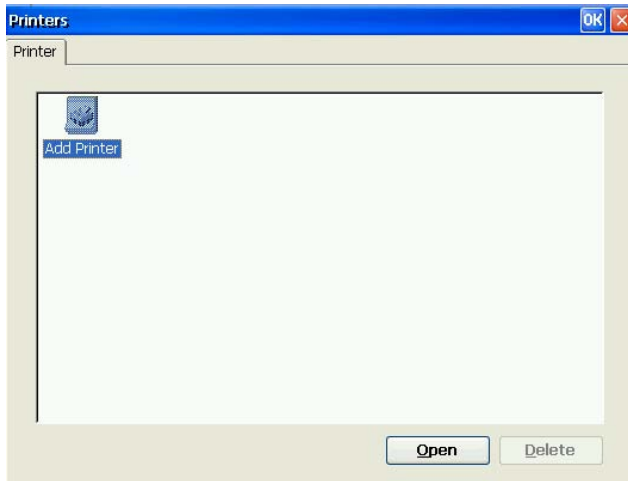

NOTE

- The eClient 630LT-GR/630LT-GR-N supports an LPTx port and a COM1 port.
- Use a RDP protocol to set the printer's adjustment.
- If you are using the ICA protocol, please refer to the instruction manual of the Citrix MetaFrame.

Adding another printer settings

Select [Add Printer] icon, and click [Open]. "Printer Properties" dialog box is displayed. Setup as following the wizard (See page 19 for the details).

Deleting a printer settings

Select the printer icon, and click [Delete].

Modifying the settings

Select the printer icon, and click [Properties]. [Printer Properties] dialog box is displayed, change the settings as needed.



Network and Dial-up Connections



Set up connection information according to the connection method to WTS/Web server (See page 15 for the details).

6-6. ICA Settings (ICA Protocol only)

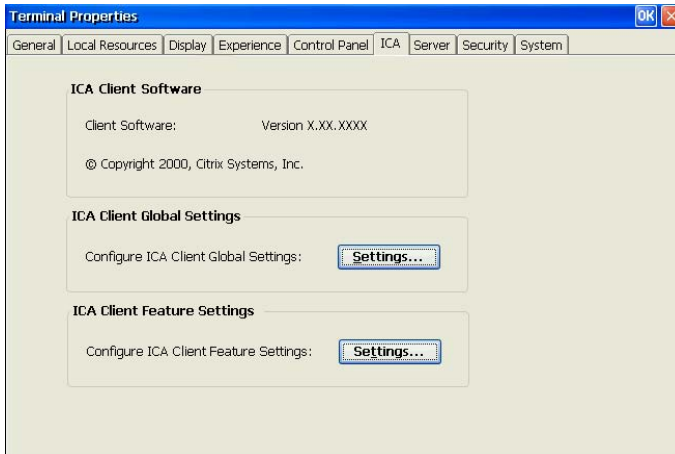

NOTE

- The settings will affect all the settings with ICA protocol.

ICA Client information

[ICA Client Software] Version of the Citrix ICA Client

ICA Client Configurations

[ICA Client Configurations]

..... You can set the configuration for the ICA Connection.

ICA Client Feature Settings

[Configure ICA Client Feature Settings]

..... You can configure ICA Client Feature Settings.

NOTE

- Do not select the [Client smartcard reader redirection] check box in the [Enable ICA Client Features]. This setting may not function properly.

6-7. Server

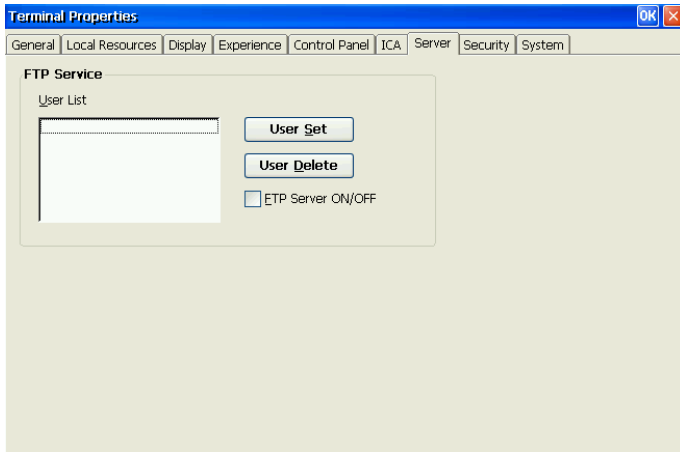

FTP Service

NOTE

- Before setting the FTP service, specify the [Password] in the [Control Panel] tab surely.

[FTP Service].....If using this eClient as a FTP server, select the FTP Server ON/OFF check box and set the user name, which is used for accessing the product from the other eClient, in the user list.

6-8. Security

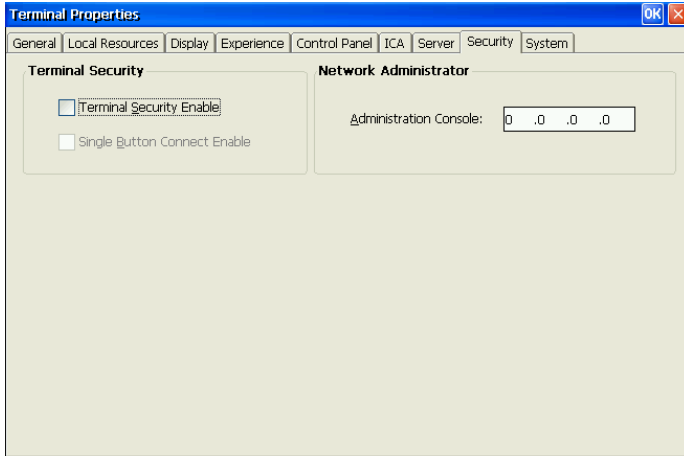

Security Settings

[Terminal Security Enable]

..... This enables settings on network information of the WTS invisible to prevent from undesirable change.

- **Security items**

Dialog box	Tab
Terminal Connection Manager	[Configure]
Terminal Properties	“Terminal Name” and “Reset” in the [General], [Local Resources], [Experience], [Control Panel (except Mouse, Keyboard and Stylus)], [ICA], [Server], [Security], “Update” in the [System]

Canceling Settings

- (1) Display “Terminal Connection Manager”.
- (2) Press [Shift] and [F2] keys at the same time.
- (3) “Enter Security Password” dialog box is displayed. Enter the password set in the [Password] of the [Control Panel].
- (4) All settings in the “Terminal Properties” will be active, remove the Terminal Security Enable check mark on [Security] tab.

[Single Button Connect Enable]

.....(Select the [Terminal Security Enable] check box to enable this check box.)

The procedure to connect to the WTS can be restricted. When this check box is selected, the “Single Button Connect” dialog box is displayed when the eClient 630LT-GR/630LT-GR-N starts up.

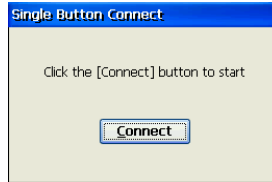

Clicking [Connect] in the “Single Button Connect” dialog box, the selected connection in the [Startup...] (see page 24) of “Terminal Connection Manager” starts up. (“Terminal Connection Manager” is not displayed.)

Canceling Settings

- (1) Display the “Single Button Connect” dialog box.
- (2) Press [Alt] and [F4] keys at the same time.
- (3) “Enter Security Password” dialog box is displayed. Enter the password set in the [Password] of the [Control Panel].
- (4) “Terminal Connection Manager” is displayed.

NOTE

- Terminal Security cannot be canceled by this setting.

Administration Console

[Administration Console]

.....Assign an IP address of a server with the Network Administrator. Other servers with the Network Administrator will not be able to control the eClient 630LT-GR/630LT-GR-N after setting the administration console.

6-9. System

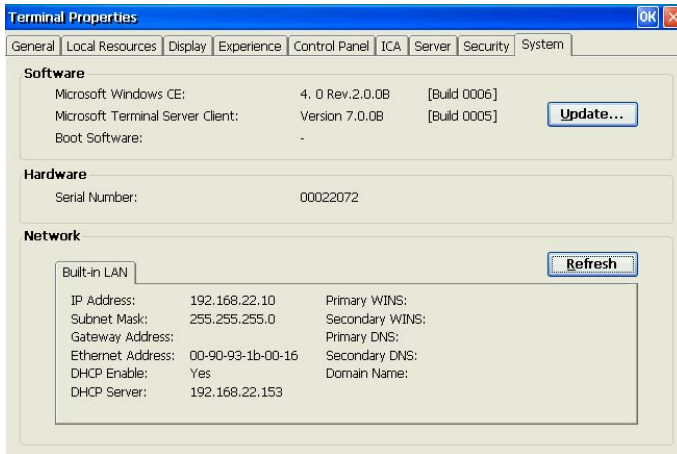

Product Information

[Software] Microsoft Windows CE Version, Revision
Window Terminal Server Client Revision
(Please refer to the page 52 on [Update...].)
[Hardware] Serial Number of the unit
[Network] Network information

7. SOFTWARE UPDATING/INSTALLATION

You can update the built-in/add-on software and install new add-on software. Updating/Installation is performed in the “Terminal Properties“.

(Built-in Software)

OS: Microsoft Windows CE.NET / BSQUARE’s JEM-CE™ Java Solutions

Applications: Microsoft Terminal Server Client (Microsoft RDP Client) / Citrix ICA Client

NOTE

- Before updating, please complete the following:
 - Copy the update/install file to the accessible file folder of the FTP Server.
 - If the WTS is connected with LAN, close all the connection to the WTS.
 - Make a dial-up connection if it is adopted to connect the WTS. Software Updating is not available if a dial-in is adopted to connect the WTS.
- When two or more 630LT-GR/630LT-GR-N exists on the same network, the firmware file (OS file only) can be updated by making any 630LT-GR/630LT-GR-N as a FTP server (see page 55 for the details).

1. Click the [Update...] of [System] tab.

The warning message appears, then confirm the message and click [Yes] to continue.

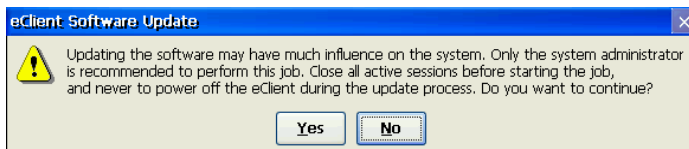

2. “Software Update” dialog box is displayed.

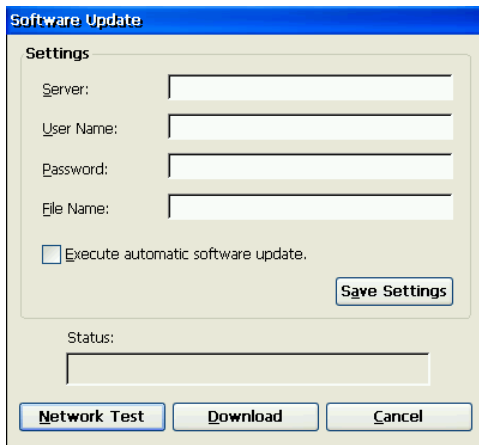

[Server:] Type IP address or full domain name of the FTP Server.

[User Name:]/[Password:] ... Type the user name and password to connect the FTP.

[File Name:] Type the folder and copied file name located in the FTP Server.

[Example]

Type the folder and file name as indicated below if the file is in the “update folder” in the “software folder”
\\software\update*.bin

NOTE

- Selecting the “Execute automatic software update.” check box will automatically consult the update file in the location indicated in the “Software Update” dialog box each time turning on the unit. If the update file consulted is newer, the software will be updated automatically while displaying the following dialog box. (This function is not available for a modem connection. Please do not click the check box.)
- When updating the software, please set the following:
 - * Keep the keyboard and the mouse connected. (Operate with the keyboard and the mouse if failed to update.)
 - * Click [Save Settings] to save settings.
- Click [Save Settings] if using the same settings for the next update.

3. Preventing from update failure, check if the settings are correct and the network environment is suitable. Click [Network Test].

If the settings are correct, the following message is displayed.

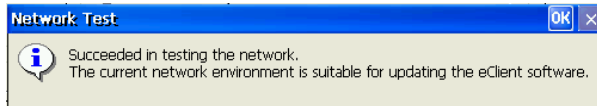

Click [OK].

4. Click [Download].

- **In case of updating the built-in software**

The following message is displayed when you successfully download the software.

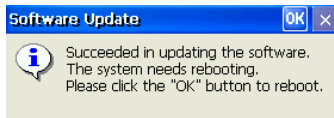

Click [OK] and restart the eClient 630LT-GR/630LT-GR-N.

- **In case of installing or updating the Add-on software**

The eClient restarts automatically when you successfully download the software.

NOTE

- Failing to download results in program's returning to the "Software Update" dialog box.

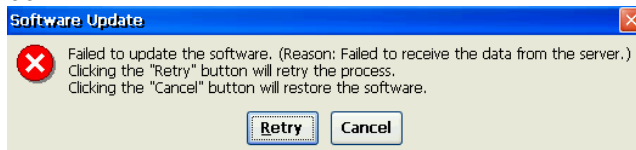

- In case of returning to the "Software Update" dialog box, confirm such as network settings and redo the [Settings] before clicking [Download].
- In case of retry dialog box is displayed, confirm connection or network settings by following the message, and click [Retry]. If the setting still fails, click [Cancel] to automatically restore the original software and restart the unit. After the unit restarts and resets the update settings. Set the "Software Update" settings once again and download the software from the FTP Server. Do not turn off the unit when this dialog box is displayed until all the process is completed. The eClient 630LT-GR/630LT-GR-N will not restart correctly.

Using the 630LT-GR/630LT-GR-N as a FTP server

The firmware file can be updated by the 630LT-GR/630LT-GR-N set as a FTP server when two or more 630LT-GR/630LT-GR-N exists on the same network

NOTE

- This updating is available for OS file (NK.bin) only.

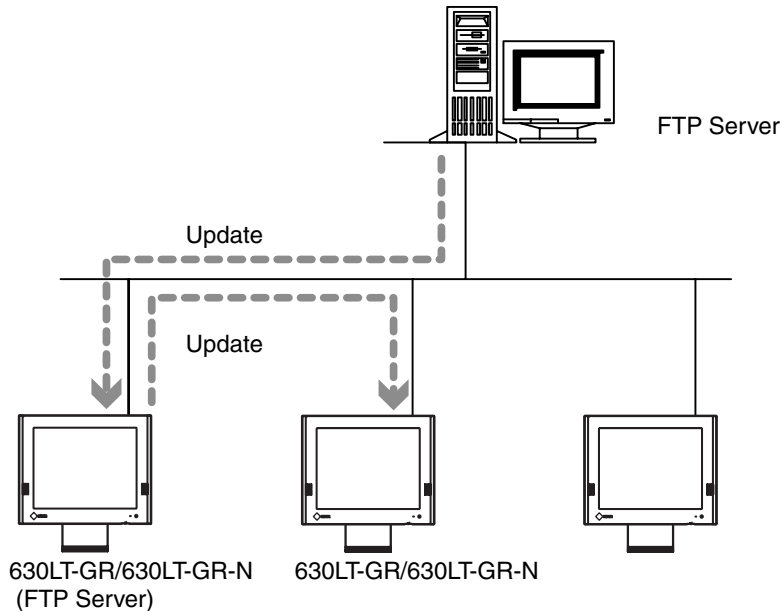

1. Update a 630LT-GR/630LT-GR-N firmware.

Refer to the previous section for the updating procedure.

2. Set the FTP Server setting of the 630LT-GR/630LT-GR-N updated on Step 1.

(Refer to page 48 for the FTP service settings.)

3. Update the other 630LT-GR/630LT-GR-N.

Specify the 630LT-GR/630LT-GR-N for FTP server in the [Settings] (Refer to below).

[Server:] Type IP address or full domain name of the 630LT-GR/630LT-GR-N.

[User Name:]/[Password:] ... Type the user name and password to connect the FTP.

[File Name:] Type the NK.bin

8. PRACTICAL SETUP

8-1. 630LT-GR/630LT-GR-N settings

By utilizing the DHCP Option function of the DHCP Server, necessary information are supplied by the DHCP Server, and each setting is automatically set every time the 630LT-GR/630LT-GR-N is turned on.

The following information can be obtained by the eClient 630LT-GR/630LT-GR-N.

- WTS/Web Server Connection Settings
- Automatic Software Update
- Security Settings
- Administration Console Setting

NOTE

- For DHCP Option settings, confirm the following:
 - The eClient 630LT-GR/630LT-GR-N is connected to the WTS/Web server through built-in LAN or connection with a LAN card
 - A DHCP Server is used for obtaining the IP address.
- If you need to change the following settings from the defaults, please change them before using the DHCP option function.

DHCP Server Settings

Please open DHCP settings to configure each DHCP Option as follows.

Items	Contents
Key	Set the value as "EIZO". (The eClient 630LT-GR/630LT-GR-N will not accept any value but "EIZO".)
Server	Type an IP address of the Server installing an update file and a registry file of the eClient 630LT-GR/630LT-GR-N.
User Name / Password	Type the user name to logon to the FTP Server. Type the password for the user name.
Automatic Update	Enable/unable an automatic connection.
File Name	Type the file name to update the software of the eClient 630LT-GR/630LT-GR-N.
Automatic Connection	Make a Registry File to connect to a WTS / Web server (Refer to the NOTE below for the settings).
Security Setting	Enable/unable the security settings.
Administration Console	Type the IP address of the Server where Network Administrator (eClient utility software) is installed.

NOTE

- Making a Registry File to Connect to a WTS/Web Server.
- Please refer to the example below, make a registry file, and save it in Unicode format. Please change the italic bold phrases as necessary.
 - **ConnectionName**: Type the connection name in the "Terminal Connection Manager".
 - **TerminalServerAddress**: Type the IP address or the full domain name of the WTS.
 - **URL**: Type the URL of the Web Server. (Including "http://".)

[HKEY_LOCAL_MACHINE\SOFTWARE\Microsoft\WBT]	
"SetupWizardEnabled"=dword:0	Specifies whether starting up "eClient Setup Wizard" or not. (Fixed to "0")
(for RDP Connection)	
[HKEY_LOCAL_MACHINE\SOFTWARE\Microsoft\WBT\Clients\Registration\RDP\Connections\ ConnectionName]	
"DeleteCmdLineArgs"="/d ConnectionName "	Command argument to delete connection information
"DeleteExe"="TSConMan"	Fixed - command (an executable file) to delete connection information.
"PropertiesCmdLineArgs"="/e ConnectionName "	Command argument to change connection information.
"PropertiesExe"="TSConMan"	Fixed - Command (executable file) to change connection information
"StartCmdLineArgs"=" ConnectionName "	Command argument to connect to a WTS
"StartExe"="mstsc.exe"	Fixed - Command (executable file) to connect to a WTS
"Description"=" ConnectionName "	Name displayed on the Connection Manager
[HKEY_CURRENT_USER\Software\Microsoft\Terminal Server Client\ ConnectionName]	
"Full Address"=" TerminalServerAddress "	IP address or full domain name of the WTS
(for ICA Connection)	
[HKEY_LOCAL_MACHINE\SOFTWARE\Microsoft\WBT\Clients\Registration\ICA\Global\WFClient]	
"Version"="2"	Event for use of ICA protocol. (Fixed to "2")
[HKEY_LOCAL_MACHINE\SOFTWARE\Microsoft\WBT\Clients\Registration\ICA\Connections\ ConnectionName]	
"DeleteCmdLineArgs"="/D: ConnectionName "	Command argument to delete connection information
"DeleteExe"="CEICAMGR"	Fixed - command (an executable file) to delete connection information.
"PropertiesCmdLineArgs"="/P: ConnectionName "	Command argument to change connection information.
"PropertiesExe"="CEICAMGR"	Fixed - Command (executable file) to change connection information
"StartCmdLineArgs"="/L " ConnectionName "	Command argument to connect to a WTS
"StartExe"="WFICACE"	Fixed - Command (executable file) to connect to a WTS
"ScreenPercent"="100"	Fixed - Assign the ratio of the client 630LT-GR/630LT-GR-N screen to the displayed Window of the WTS.
"Description"=" ConnectionName "	Name displayed on the Connection Manager
"Address"=" TerminalServerAddress "	IP address or full domain name of the Meta Frame Server

(for Web Connection)

[HKEY_LOCAL_MACHINE\SOFTWARE\Microsoft\WBT]	
"SetupWizardEnabled"=dword:0	Specifies whether starting up "eClient Setup Wizard" or not. (0; not starting up, 1; starting up)
[HKEY_LOCAL_MACHINE\SOFTWARE\Microsoft\WBT\Clients\Registration\Web\Connections\Web1]	
"StartCmdLineArgs"=" URL "	Specifies the URL (including http://) to access.
[HKEY_LOCAL_MACHINE\SOFTWARE\Microsoft\WBT\Shell]	
"EnableAutoConnect"=dword:1	Specifies whether to enable/disable automatic connection. (0;disable, 1;enable)
"ConnectionDefaultKey"=" ConnectionName "	Specify connection information name of the automatic connection.
"ConnectionDefaultType"="RDP"	Specify the type of the automatic connection. (The type is RDP, ICA, or Web.)

*1 One entry name can be set at the Administration Console function.

eClient 630LT-GR/630LT-GR-N Settings

Please confirm the following settings in the [Control Panel] tab of [Terminal Properties].

[Network and Dial-up Connections] tab

- In case of the connection to the WTS/Web server through built-in LAN
 - IP address setting
 - selecting of [Obtain an IP address via DHCP]
- In case of the connection with a LAN card
 - IP address setting
 - selecting of [Specify an IP address] and typing “255.255.255.255”.

[DHCP Settings]

- [General] tab
 - : Specifying the [Target Adapter] (Built-in LAN or LAN card) [DHCP Options] tab
- [DHCP Options] tab
 - : Selecting [Enable DHCP Options] and typing each option number settings.

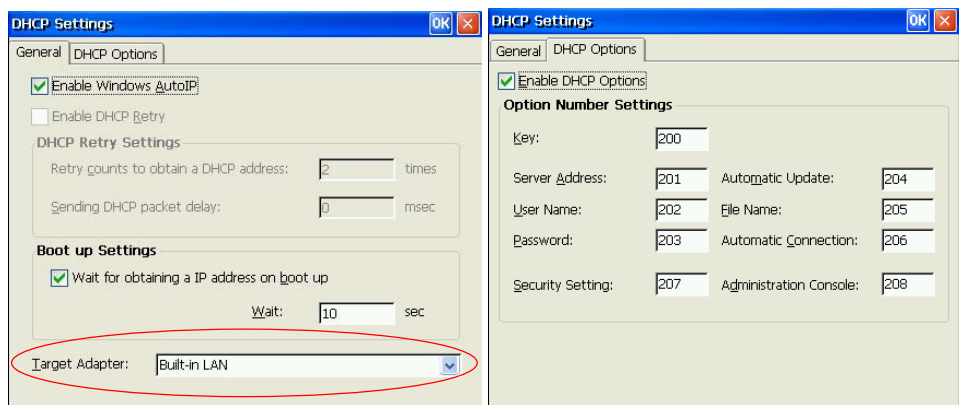

NOTE

- If the DHCP Option is used to setup the eClient 630LT-GR/630LT-GR-N for the first time, “Terminal Connection Manager” will appear because the unit automatically receives information from the DHCP Server. (“eClient Setup Wizard will not be displayed.)
- If the DHCP Option is set once and needs to be canceled, please change the key of the DHCP Server. Even if changing the DHCP Option in the eClient 630LT-GR/630LT-GR-N, the DHCP Server will overwrite the option next time the unit is restarted, and the changes in the eClient 630LT-GR/630LT-GR-N will not be effective.

8-2. Short cut command by keyboard

Function		Short cut command
Brightness	Increase	[Alt] key and [+] key
	Decrease	[Alt] key and [-] key
Display “Terminal Connection Manager” dialog box (after WTS / Web connection)		Press [Ctrl] + [Alt] + [End]
Display “Terminal Properties” dialog box		Press [F2] in the “Terminal Connection Manager” dialog box.
Canceling the security settings		Press [Shift] + [F2] in the “Terminal Connection Manager” dialog box.
Switching the Active Session of the WTS for the multi session		Press [Ctrl] + [Alt] + [↑] / [↓]

9. TROUBLESHOOTING

This page presents problem that can be corrected by the user. If a problem persists even after applying the suggested remedies, contact an EIZO dealer.

Problems	Points to check with possible solutions
<p>1. No picture is displayed on the screen.</p>	<ul style="list-style-type: none"> <input type="checkbox"/> Check if the power is OFF. <input type="checkbox"/> Check brightness setting. Minimum settings will cause screen to be blank. <input type="checkbox"/> Try pressing a key on the keyboard, or clicking the mouse. (The monitor may be in a power saving mode.)
<p>2. The following messages appear on screen after the power is on: (The operation automatically starts up after the message disappears.)</p> <ul style="list-style-type: none"> • “WARNING No Keyboard Connected!!” • “WARNING No Mouse Connected!!” 	<ul style="list-style-type: none"> <input type="checkbox"/> Check if the cable of the keyboard or the mouse is securely connected. <input type="checkbox"/> Check if the cable of the keyboard or the mouse is connected to the proper connector. (In use of a stylus or a finger as an input device, “No Mouse Connected!!” caution does not effect your operation.) <input type="checkbox"/> Turn off the power, and turn it on a few seconds later. <p>NOTE When using neither a mouse nor a keyboard intentionally, it is made to a setup on which an error is not displayed (See P.39).</p>
<p>3. Input devices (such as a keyboard or a mouse) do not work properly.</p>	<p>Solution on a mouse or a keyboard</p> <ul style="list-style-type: none"> <input type="checkbox"/> Check if the cable of the keyboard or the mouse is securely connected. <input type="checkbox"/> Check if the keyboard or the mouse is connected to the proper connector. <p>Solution on a stylus</p> <ul style="list-style-type: none"> <input type="checkbox"/> The touch panel may not be calibrated properly. Please recalibrate the touch panel. <p>Solution on a keyboard, a mouse, and a stylus</p> <ul style="list-style-type: none"> <input type="checkbox"/> Check if the network cable or the modem is cable is connected. (To make sure the Ethernet cable is connected securely; check if one of the indicators on the Ethernet connector turns green.)
<p>4. Afterimages appear on the screen.</p>	<ul style="list-style-type: none"> <input type="checkbox"/> Do you use the screen saver when displaying the same image for extended periods of time? <input type="checkbox"/> Afterimages are particular to LCD monitors. Avoid displaying the same image for extended periods of time.

Problems	Points to check with possible solutions
5. The screen has defective pixels (e.g. slightly light or dark).	<input type="checkbox"/> This is due to the characteristics of the panel itself, and not the failure.
6. Finger prints appear on the screen.	<input type="checkbox"/> Leaving the white screen on may solve the problem.

10. CLEANING

Periodic cleaning is recommended to keep the monitor looking new and to prolong its operation lifetime.

NOTE

- Never use thinner, benzene, alcohol (ethanol, methanol, or isopropyl alcohol), abrasive cleaners, or other strong solvents, as these may cause damage to the cabinet or LCD panel.

Cabinet

To remove stains, wipe the cabinet with a soft, lightly moistened cloth using a mild detergent. Do not spray wax or cleaner directly onto the cabinet.

LCD Panel

The LCD surface can be cleaned with a soft cloth, such as cotton or lens paper.

If necessary, stubborn stains can be removed by moistening part of a cloth with water to enhance its cleaning power.

Mouse

If you find that the pointer on the screen doesn't move smoothly, your mouse needs to be cleaned. Periodically clean the mouse for your operation.

- (1) Turn off the 630L.
- (2) Turn the mouse upside down and remove the mouse trackball cover. Press the cover towards "Open" while pulling the other side of the cover.

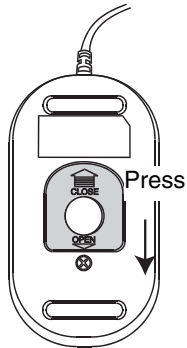

- (3) Remove the trackball.
- (4) Wipe the trackball with a soft cloth with neutral detergent.
- (5) Clean all the rollers, getting all the lint off of them.
You can use a wet cotton swab to clean the rollers. Turn them to clean the entire roller.

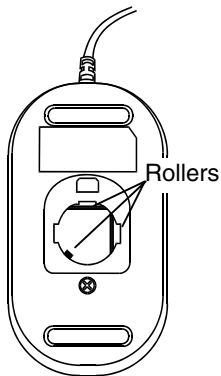

- (6) Remove the dust inside of the mouse.
- (7) Put the trackball back into the mouse.
- (8) Close the mouse trackball cover.

11. SPECIFICATIONS

Processing Unit	CPU	National Semiconductor Geode GX1, 300 MHz
	Memory	RAM: 64 MB, ROM: 32 MB
	LAN	10 BASE-T/100BASE-TX, Wake On LAN supported
	Speakers	Output Level: 1 W + 1 W, stereo
Display Device	LCD Panel	38 cm (15 inch) TFT color LCD panel Anti-Glare Hard Coating (Viewing Angle: Horizontal: 160°, Vertical: 150°)
	Dot Pitch	0.297 mm x 0.297 mm
	Resolution	1024 x 768
	Viewable Image Size	304.1 mm (H) x 228.1 mm (V) (11.9" (H) x 8.9" (V))
	Display Color	256 / 65536 colors
Touch Panel		Defective Method: Analog resistive type Surface Treatment: Non-Glare Coating
Complying Protocol		Microsoft Remote Desktop (RDP) Citrix Independent Computing Architecture (ICA)
Software		Microsoft Windows CE.NET BSQUARE's JEM-CE™ Java Solutions Microsoft RDP Client Citrix ICA Client 7.0 or later
Complying Software for a Windows Terminal Server		Microsoft Windows NT Server 4.0 Terminal Server Edition, Microsoft Windows 2000 Server / Advanced Server /DataCenter Server, Citrix MetaFrame 1.8 / 1.8 + FR1 / XP /XP + FR1
Mouse		PS/2 2 button Mouse
Power Supply		100-120/200-240 VAC ± 10 %, 50/60 Hz, 0.8/0.5 A
Power Consumption		Min. 31 W (Min.) Max. 45 W (with keyboard, Mouse, USB, LAN, PC card) Power saving mode less than 10 W
Interface Connector	LAN	10BASE-T/100BASE-TX (RJ-45) x 1
	Keyboard, Mouse	PS/2 (Mini DIN 6 pin) x 2
		USB Port (Downstream) x 2
	Parallel	IEEE1284 (D-Sub 25 pin) x 1
	Serial Port	RS-232C (D-Sub 9 pin) x 1
	PC Card Slot	PCMCIA Type II (68 pin) x 1
	Line Output	Stereo mini jack x 1
	Monaural Microphone**	Mini jack x 1
Dimensions (With the tilt stand)		395 mm (W) x 390 mm (H) x 164 mm (D) (15.6" (W) x 15.4" (H) x 6.5" (D))
Weight		5.2 kg (11.5 lbs.) (without the tilt stand: 4.0 kg (8.8 lbs.))
Environmental Specifications		Temperature Operating: 0°C to 35°C (32°F to 95°F) Storage: -20°C to 60°C (-4°F to 140°F) Humidity 30 % to 80 % R.H. Non-condensing

Certifications and Standards	
100-120 VAC range	TÜV/NRTL, c-TÜV, FCC class A, CB, TÜV Rheinland Ergonomics Approved, EPA ENERGY STAR® program, TCO'99 ²
200-240 VAC range	CE, CB, TÜV Rheinland/GS, TÜV Rheinland/Ergonomic Approved, EPA ENERGY STAR® program, TCO'99 ²

*1 Monaural microphone connector is not available now.

*2 Applicable to only gray (standard color) version.

Dimensions

mm (inches)

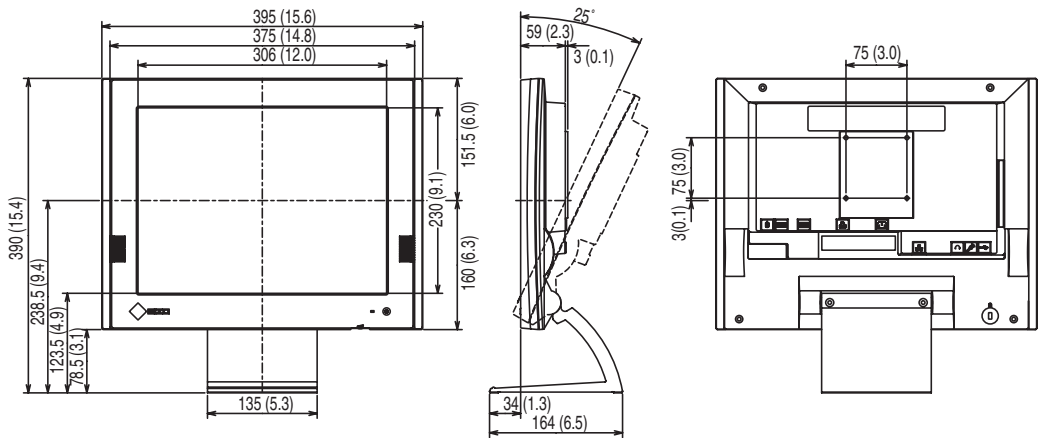

12. REFERENCE

12-1. Attaching an Arm Stand

The eClient 630LT-GR/630LT-GR-N can be used with an arm stand by removing the tilt stand and attaching the arm stand to the terminal.

NOTE

- Use an arm stand that satisfies the following.
 - When using the eClient 630LT-GR/630LT-GR-N with an arm stand, the arm stand must be VESA approved:
 - Use an arm stand with a 75 mm x 75 mm hole spacing on the arm mounting pad.
 - Use an arm stand that is able to support an object weighing 8.0 kg.
 - A GS approved arm stand.
 - Use an arm stand with sufficient stability (mechanical firmness) to support the weight of the monitor.
 - Use an arm stand remaining that position where it is manually moved.
 - Use an arm stand with the ability to tilt the monitor forward and backward.
- Please connect cables after attaching an arm stand.

Setup Procedure

- 1.** Lay the eClient 630LT-GR/630LT-GR-N down as shown below. Do not scratch the panel.
- 2.** Remove the stand by loosening the screws (M4 x 16 mm).
- 3.** Attach an arm stand to the eClient 630LT-GR/630LT-GR-N securely.

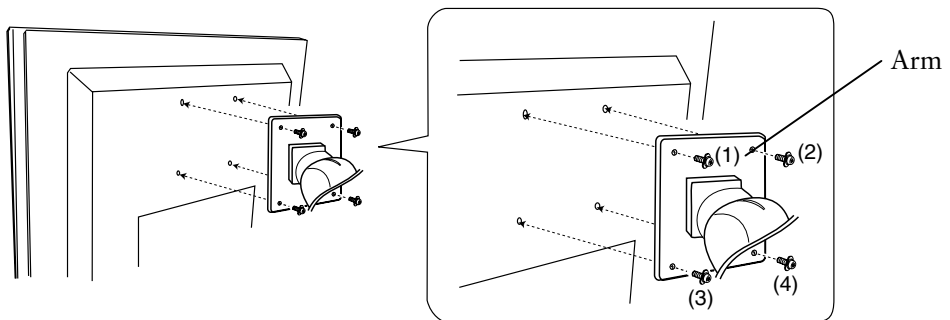

(1), (2), (3), (4): Enclosed Screws, M4 x 12 mm

INDEX

A

- ADDING & CHANGING A CONNECTION NAME 21
- Add-on 44
- Administration Console..... 50
- Attaching an Arm Stand 66
- Automatic Logon..... 22, 23
- Autostart Connection 24

B

- Brightness 6, 36

C

- Certificates 43
- Cleaning 62
- CONNECTING 9
- connection name..... 22, 23
- Connection speed 37
- Control Panel 38

D

- Date / Time..... 42
- desktop color..... 18, 23, 35
- Device..... 34
- DHCP..... 43, 56
- Dial-In 23
- dial-up connection..... 14, 17
- Disconnect..... 28
- Display 35

E

- eClient Setup Wizard 12
- Experience 37

F

- firewalls 23
- FTP Service..... 48

I

- ICA..... 21, 23, 47
- Internet Options 19, 44

K

- Keyboard..... 10, 39

L

- Local Resources..... 34
- Location name..... 20, 38
- Logon & Logoff 25

M

- Making a Registry File 57
- Mouse 6, 40
- Mouse Right Click Emulation 40
- Multi Session 26

N

- Network and Dial-up Connections..... 46

O

- Opening/Closing a Local Web Browser ... 29

P

- Password 39
- Power save..... 36
- PRACTICAL SETUP 56
- printer 19, 45
- Product Information 33, 51
- Protocol..... 22, 23

R

- RDP..... 21, 22
- Reference..... 66
- refresh rate 18, 35
- Resetting to Default..... 33
- resolution 18, 35

S

- Security..... 49
- Server 48
- Setting up 9, 11
- Short cut command by keyboard..... 60
- SOFTWARE UPDATING/INSTALLATION 52
- Sound 34, 41
- Specifications..... 64
- start up an application..... 23
- Subnet Mask..... 15, 16
- System 51

T

- Terminal Connection Manager 20, 22, 23
- Terminal Name..... 14
- Terminal Properties 31, 52
- Touch screen calibration..... 11
- Troubleshooting 60, 61

W

- WTS 5
- WTS Connection Wizard..... 22