

# User's Manual

## ColorEdge<sup>®</sup> CG247X

Color Management LCD Monitor

### Important

Please read PRECAUTIONS, this User's Manual, and the Setup Guide (separate volume) carefully to familiarize yourself with safe and effective usage.

- 
- Please refer to the Setup Guide for basic information ranging from connection of the monitor to a PC to using the monitor.
  - The latest User's Manual is available for download from our web site:  
<http://www.eizoglobal.com>
- 



## Location of Caution Statement

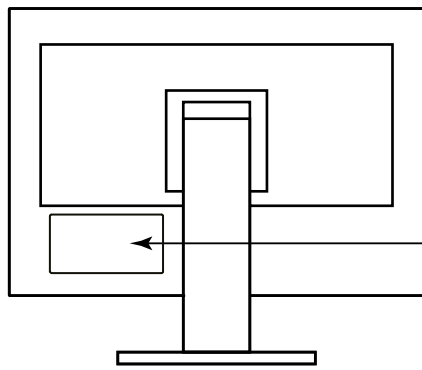

  
**WARNING**  
RISK OF ELECTRIC SHOCK. DO NOT OPEN.

**AVERTISSEMENT**  
RISQUE DE CHOC ELECTRIQUE. NE PAS OUVRIR.

**WARNUNG**  
GEFAHR DES ELEKTRISCHEN SCHLAGES. RÜCKWAND NICHT ENTFERNEN.

警告  
触电危険，请勿打开后盖。

警告  
感電の恐れあり，カバーをあげないでください。

The equipment must be connected to a grounded main outlet.  
L'appareil doit être relié à une prise avec terre.  
Jordet stikkontakt skal benyttes når apparatet tilkobles datanett.  
Apparaten skall anslutas till jordat nätuttag.  
设备必须连接到接地的电源插座。  
電源コードのアースは必ず接地してください。

This product has been adjusted specifically for use in the region to which it was originally shipped. If operated outside this region, the product may not perform as stated in the specifications.

No part of this manual may be reproduced, stored in a retrieval system, or transmitted, in any form or by any means, electronic, mechanical, or otherwise, without the prior written permission of EIZO Corporation. EIZO Corporation is under no obligation to hold any submitted material or information confidential unless prior arrangements are made pursuant to EIZO Corporation's receipt of said information. Although every effort has been made to ensure that this manual provides up-to-date information, please note that EIZO monitor specifications are subject to change without notice.

# Notice for this monitor

---

Aside from general purposes like creating documents and viewing multimedia content, this product is also suited to applications such as creating images and graphics, and digital photo processing, where accurate color reproduction is a priority.

---

This product has been adjusted specifically for use in the region to which it was originally shipped. If the product is used outside the region, it may not operate as specified in the specifications.

---

This product may not be covered by warranty for uses other than those described in this manual.

---

The specifications noted in this manual are only applicable when the following are used:

- Power cords provided with the product
  - Signal cables specified by us
- 

Only use optional products manufactured or specified by us with this product.

---

If you place this product on a lacquer-coated desk, the color may adhere to the bottom of the stand due to the composition of the rubber. Check the desk surface before use.

---

It takes about 3 minutes (under our measurement conditions) for the performance of electrical parts to stabilize. Please wait 3 minutes or more after the monitor power has been turned on, and then adjust the monitor. It is necessary to wait at least 30 minutes after turning on the power, in order to obtain correct measurement results.

---

Monitors should be set to a lower brightness to reduce changes in luminosity caused by long-term use and maintain a stable display.

---

When the screen image is changed after displaying the same image for extended periods of time, an afterimage may appear. Use the screen saver or power save function to avoid displaying the same image for extended periods of time.

---

If the monitor displays continuously over a long period of time, dark smudges or burn-in may appear. To maximize the life of the monitor, we recommend the monitor be turned off periodically.

---

Periodic cleaning is recommended to keep the monitor looking new and to prolong its operation lifetime (refer to [“Cleaning” \(page 4\)](#)).

---

The LCD panel is manufactured using high-precision technology. Although, missing pixels or lit pixels may appear on the LCD panel, this is not a malfunction. Percentage of effective dots: 99.9994% or higher.

---

The backlight of the LCD panel has a fixed lifetime. When the screen becomes dark or begins to flicker, please contact your local EIZO representative.

---

Do not press on the panel or edge of the frame strongly, as this may result in display malfunctions, such as interference patterns, etc. If pressure is continually applied to the panel, it may deteriorate or damage your panel. (If the pressure marks remain on the panel, leave the monitor with a black or white screen. The symptom may disappear.)

---

Do not scratch or press on the panel with any sharp objects, as this may result in damage to the panel. Do not attempt to brush with tissues as this may scratch the panel.

---

---

When the monitor is cold and brought into a room or the room temperature goes up quickly, dew condensation may occur on the interior and exterior surfaces of the monitor. In that case, do not turn the monitor on. Instead wait until the dew condensation disappears, otherwise it may cause some damage to the monitor.

---

## Cleaning

---

### **Attention**

- Chemicals such as alcohol and antiseptic solution may cause gloss variation, tarnishing, and fading of the cabinet or panel, and also quality deterioration of the image.
  - Never use any thinner, benzene, wax, and abrasive cleaner, which may damage the cabinet or panel.
- 

The stains on the cabinet and panel surface can be removed by using the provided ScreenCleaner.

## To use the monitor comfortably

---

- An excessively dark or bright screen may affect your eyes. Adjust the brightness of the monitor according to the environmental conditions.
- Staring at the monitor for a long time tires your eyes. Take a 10-minute rest every hour.

# Contents

<b>Notice for this monitor</b> .....	<b>3</b>	<b>3-5. Changing DUE (Digital Uniformity Equalizer) Setting</b> .....	<b>32</b>
Cleaning .....	4	<b>3-6. Reset to default</b> .....	<b>33</b>
To use the monitor comfortably .....	4	● Resetting the color adjustments .....	33
<b>Contents</b> .....	<b>5</b>	● Resetting all adjustments to defaults .....	33
<b>Chapter 1 Introduction</b> .....	<b>7</b>	<b>Chapter 4 SelfCalibration</b> .....	<b>34</b>
<b>1-1. Features</b> .....	<b>7</b>	<b>4-1. Setting the Color Mode for Executing SelfCalibration</b> .....	<b>34</b>
<b>1-2. Controls and Functions</b> .....	<b>9</b>	● CAL mode .....	34
● Front .....	9	● Standard Mode .....	35
● Rear .....	10	<b>4-2. Setting Monitor Date and Time</b> .....	<b>35</b>
<b>1-3. EIZO LCD Utility Disk</b> .....	<b>11</b>	<b>4-3. Setting Calibration Schedule</b> .....	<b>36</b>
● Disk contents .....	11	<b>4-4. Setting the calibration targets</b> .....	<b>38</b>
● To use ColorNavigator 6 .....	11	<b>4-5. Executing SelfCalibration</b> .....	<b>39</b>
<b>1-4. Basic Operations and Functions</b> .....	<b>12</b>	<b>4-6. Checking Adjustment Results</b> .....	<b>40</b>
● Basic Adjustment menu operations .....	12	● To check adjustment results with CAL mode .....	40
● Functions .....	13	● To check adjustment results with Standard Mode .....	40
<b>Chapter 2 Adjusting Screens</b> .....	<b>15</b>	<b>Chapter 5 Connecting Multiple External Devices</b> .....	<b>41</b>
<b>2-1. Setting Resolution</b> .....	<b>15</b>	<b>5-1. Switching among Input Signals</b> .....	<b>42</b>
● Compatible Resolutions/Formats .....	15	<b>5-2. Setting Input Signal Switching Procedure</b> .....	<b>42</b>
● To switch signal formats (Only for DisplayPort or HDMI signal input) .....	16	<b>5-3. Skipping Unused Input Signals</b> .....	<b>42</b>
● To set the display resolution for the OS .....	16	<b>5-4. Switching USB Port Automatically</b> .....	<b>43</b>
● To select screen size .....	17	<b>Chapter 6 Power Saving Functions</b> .....	<b>44</b>
<b>2-2. Selecting the display mode (color mode)</b> .....	<b>19</b>	<b>6-1. Setting Power Save</b> .....	<b>44</b>
<b>2-3. Adjusting the Color</b> .....	<b>20</b>	<b>6-2. Adjusting Brightness of Front Button</b> .....	<b>45</b>
● To adjust brightness .....	20	<b>6-3. Setting DisplayPort Power Save</b> .....	<b>45</b>
● To adjust the temperature .....	21	<b>Chapter 7 Troubleshooting</b> .....	<b>46</b>
● To adjust gamma .....	22	<b>7-1. No picture</b> .....	<b>46</b>
● To set color gamut .....	22	<b>7-2. Imaging problems</b> .....	<b>47</b>
● To perform advanced adjustments .....	23	<b>7-3. Other problems</b> .....	<b>48</b>
<b>2-4. Specifying Color Space</b> .....	<b>26</b>	<b>7-4. Built-in calibration sensor and SelfCalibration problems</b> .....	<b>49</b>
<b>2-5. Expanding Signal Output Range</b> .....	<b>27</b>	<b>Chapter 8 Reference</b> .....	<b>50</b>
<b>2-6. Setting HDMI</b> .....	<b>28</b>	<b>8-1. Attaching the Optional Arm</b> .....	<b>50</b>
● To reduce noise .....	28	<b>8-2. Making Use of USB (Universal Serial Bus)</b> .....	<b>51</b>
● To select how to display interlace signal .....	28	● System Requirements .....	51
● To set safe area .....	29	● How to connect .....	51
<b>Chapter 3 Setting the Monitor</b> .....	<b>30</b>	<b>8-3. Showing Monitor Information</b> .....	<b>52</b>
<b>3-1. Setting Adjustment Menu</b> .....	<b>30</b>	● Displaying signal information .....	52
● Selecting the Language .....	30	● Displaying Monitor Information .....	52
● Setting Orientation .....	30		
● To change adjustment menu display position .....	31		
<b>3-2. Skipping Unused Display Modes</b> .....	<b>31</b>		
<b>3-3. Showing and Hiding the EIZO Logo</b> .....	<b>31</b>		
<b>3-4. Locking Operation Buttons</b> .....	<b>32</b>		

8-4. Specifications ..... 53

**Chapter 9 Glossary ..... 56**

**Appendix ..... 59**

    Trademark ..... 59

    License / Copyright ..... 59

    FCC Declaration of Conformity ..... 60

    LIMITED WARRANTY ..... 61

    Recycling Information ..... 62

# Chapter 1 Introduction

## 1-1. Features

- 24.1" widescreen
- Wide color gamut (Adobe® RGB coverage: 99%)
- Achieves contrast ratio of 1500:1\*1
  - A high contrast ratio allows for display of crisper black with reduced whiteness.
  - \*1 Standard value. When "DUE Priority" is set to "Brightness"
- Supports a resolution of 1920 × 1200
- IPS panel with 178° wide viewing angle in landscape and portrait mode.
- Frame synchronization mode supported (23.75–30.5 Hz, 47.5–61.0 Hz)
- 3 signal input terminals (DVI-D × 1, HDMI × 1, DisplayPort × 1)
  - DisplayPort (supports 8 bit and 10 bit)\*1
  - HDMI (supports 8 bit, 10 bit, and 12 bit)\*1. \*2
    - Can handle PC signals in HDMI input
- \*1 Audio is not supported.
- \*2 The maximum screen display is 10 bits.
- Color mode function
  - Reproduces a color temperature, gamma, and gamut compliant with the following standards.
  - Broadcasting standards "EBU/REC709/SMPTE-C"
  - Digital cinema standard "DCI"
  - Adobe® RGB / sRGB
- See "2-2. Selecting the display mode (color mode)" (page 19)
- An Adjustment Certificate, which describes the factory measurement results of the grayscale and uniformity characteristics is attached for each monitor.
- This product is equipped with a built-in calibration sensor, and supports SelfCalibration in which the monitor executes calibration independently.
  - See "Chapter 4 SelfCalibration" (page 34)
- The provided Color Management Software "ColorNavigator 6" enables you to calibrate monitor characteristics and generate color profiles
  - See "1-3. EIZO LCD Utility Disk" (page 11)
- Monitor hood is included
  - Includes a monitor hood that can effectively shield the monitor from the reflection of external lighting, such as the reflected glare of a fluorescent light.
- Displays HDCP (High Bandwidth Digital Protection) protected content.

## **Attention**

---

**Be careful of the following points when using the built-in calibration sensor.**



**Do not touch the built-in calibration sensor.**

It may reduce the measurement accuracy of the built-in calibration sensor, or result in injury or equipment damage.

---

**Attention**

- A high temperature or high humidity environment may affect the measurement accuracy of the built-in calibration sensor. We suggest storing and using the monitor under the following conditions.

- Temperature 30 °C or less
- Humidity 70% or less

Avoid storing or using the sensor where it may be exposed to direct sunlight.

- Since the measurement result for the built-in sensor may be affected, ensure that the level of ambient light that enters the receiver part of the built-in sensor does not change significantly during measuring.
    - The use of a monitor hood is recommended.
    - While measuring, do not bring your face or any objects close to the monitor, do not look into the sensor.
    - Set the monitor in the environment so that external light does not enter the sensor directly.
- 
-



# 1-2. Controls and Functions

## ● Front

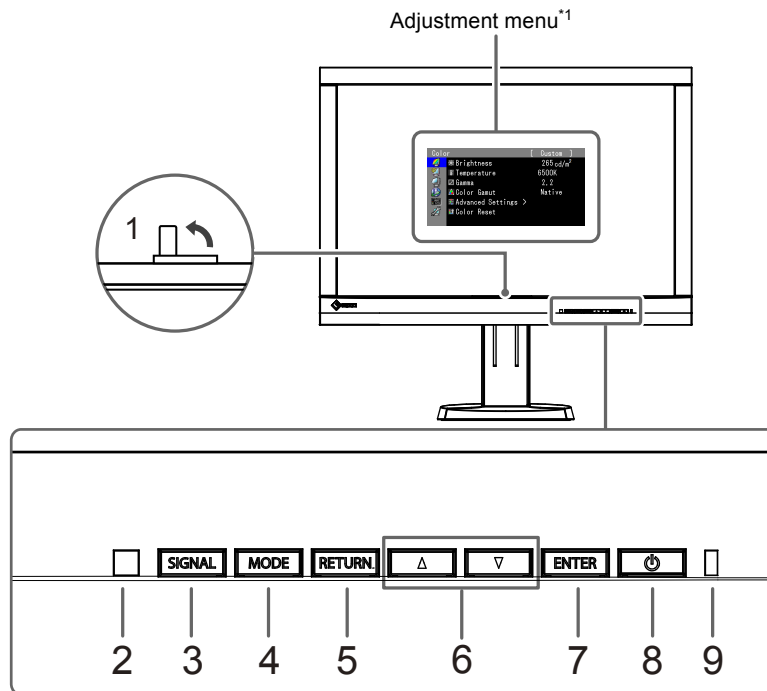

<b>1. Built-in calibration sensor</b>	Executes calibration for independent monitors. SelfCalibration function ( <a href="#">page 34</a> ) <b>Attention</b> • Do not touch the sensor as this will affect the measurement accuracy.
<b>2. Ambient Light Sensor</b>	Measures ambient light.
<b>3. SIGNAL button</b>	Switches input signals for display ( <a href="#">page 42</a> ).
<b>4. MODE button</b>	Changes Color Mode ( <a href="#">page 19</a> ).
<b>5. RETURN button</b>	Cancels the setting/adjustment and displays the Adjustment menu.
<b>6. ▲/▼ button</b>	<ul style="list-style-type: none"> <li>• Provides the menu selection as well as the adjustment and setting of a function.</li> <li>• Displays the Brightness menu (<a href="#">page 20</a>).</li> </ul>
<b>7. ENTER button</b>	Displays the Adjustment menu, determines adjustment items on the menus, and saves values adjusted.
<b>8. ⏻ button</b>	Turns the power on or off.
<b>9. Power indicator</b>	Indicates the monitor's operation status.  Blue : Operating  Flashing blue (2 quick flashes at a time) : Indicates that recalibration is required if the SelfCalibration schedule ( <a href="#">page 36</a> ) is set.  Orange : Power saving mode  OFF : Main power/Power off

\*1 See "1-4. Basic Operations and Functions" ([page 12](#)) for instructions on how to use.

## ● Rear

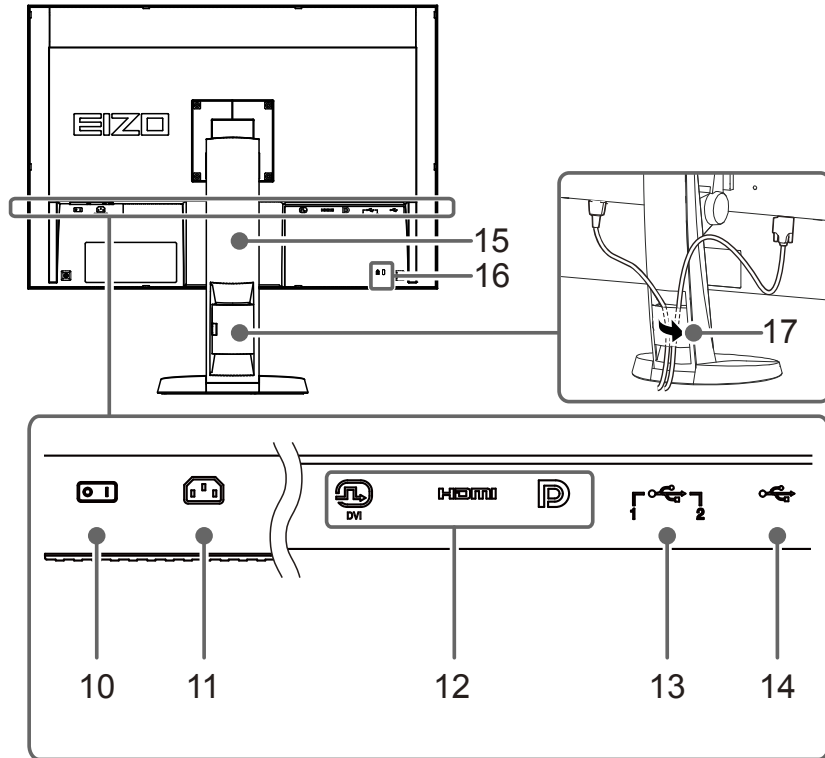

<b>10. Main power switch</b>	Turns the main power on or off.   : On    ○ : Off
<b>11. Power connector</b>	Connects the power cord.
<b>12. Input signal connectors</b>	Left: DVI-D connector Middle: HDMI connector Right: DisplayPort connector
<b>13. USB upstream port</b>	Connects to the USB cable when using software that requires a USB connection, or when using the USB Hub function. (page 51)
<b>14. USB downstream port</b>	Connects to a peripheral USB device.
<b>15. Stand<sup>*2</sup></b>	Used to adjust the height and angle of the monitor screen. <b>Attention</b> • Do not hold the sensor section on the front side of the monitor when adjusting the height or angle.
<b>16. Security lock slot</b>	Complies with Kensington's MicroSaver security system.
<b>17. Cable holder</b>	Covers the monitor cables.

<sup>\*2</sup> An optional arm (or an optional stand) can be attached by removing the stand section (see "1-4. Basic Operations and Functions" (page 12)).

## 1-3. EIZO LCD Utility Disk

An “EIZO LCD Utility Disk” (CD-ROM) is supplied with this product. The disk contents are shown below:

### ● Disk contents

The disk includes application software programs for calibration, and the User's Manual. Refer to “Readme.txt” or the “read me” file on the disk for software startup procedures or file reference procedures.

Contents	Windows	Macintosh
• A “Readme.txt” or “read me” file	√	√
• ColorNavigator 6 - An application software for measuring and calibrating monitor characteristics and generating ICC profiles (for Windows) and Apple ColorSync profiles (for Macintosh). (The monitor and PC must be connected using the USB cable.)	√	√
• Screen adjustment pattern files*1 - Used when adjusting the image for analog signal input manually.	√	-
• User's Manual of this monitor (PDF file)	√	√

\*1 This monitor does not support analog signal input, so these files are not used.

### ● To use ColorNavigator 6

Refer to the User's Manual on the CD-ROM disk for details on how to install and use the software. When using this software, you will need to connect a PC to the monitor with the supplied USB cable. For details of the USB cable connection, see [“8-2. Making Use of USB \(Universal Serial Bus\)” \(page 51\)](#).

# 1-4. Basic Operations and Functions

## ● Basic Adjustment menu operations

### 1. Displaying Adjustment Menu

1. Press any button (except  $\text{O}$ ).  
A guide indicating the button functions is displayed.

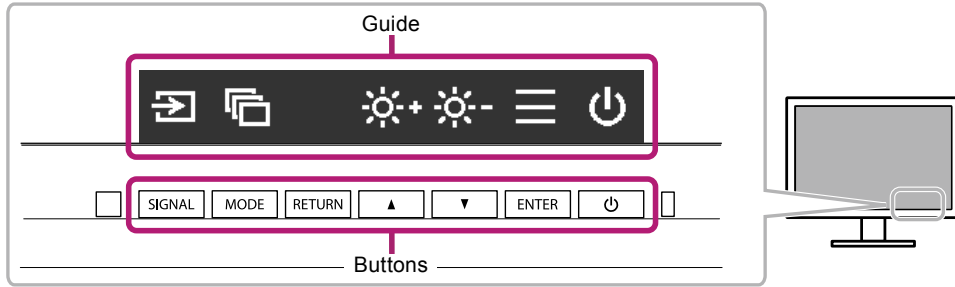

2. Press ENTER. The Adjustment menu appears.

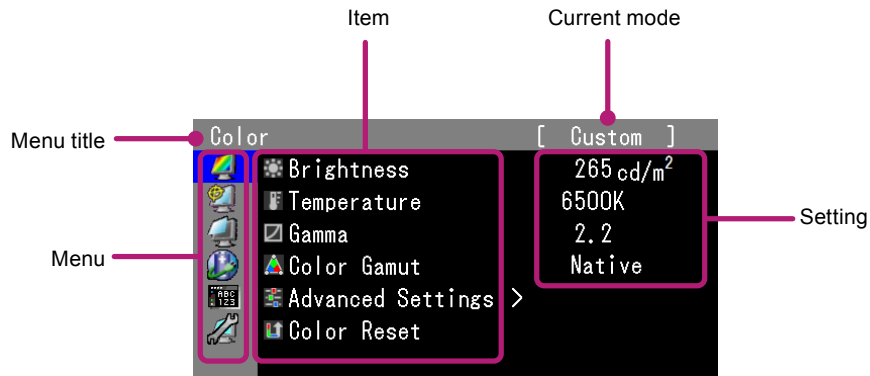

### 2. Adjusting/setting

1. Using  $\blacktriangle/\blacktriangledown$ , select the menu you want to adjust/set and press ENTER.

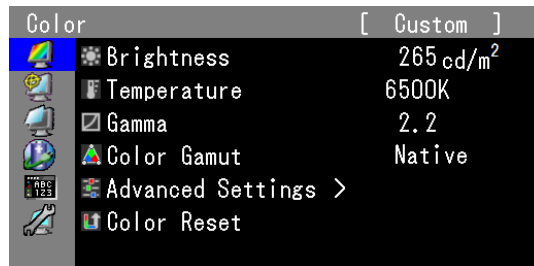

2. Using  $\blacktriangle/\blacktriangledown$ , select the item you want to adjust/set and press ENTER.

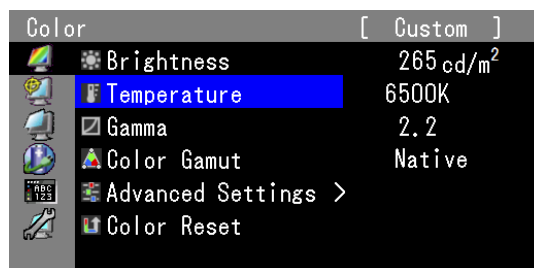

3. Using ▲/▼, adjust/set the selected item and press ENTER.

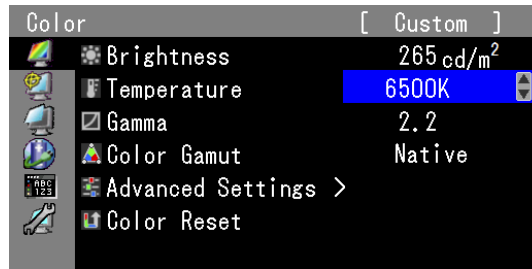































### 3. Exiting

1. Press RETURN a few times to exit the Adjustment menu.

### ● Functions

The following table shows the menus for adjustment and setting items of each menu.

Main Menu	Item	Reference	
Color (Standard Mode)* <sup>1</sup> 	 Brightness	"2-3. Adjusting the Color" (page 20)	
	 Temperature		
	 Gamma		
	 Color Gamut		
	 Advanced Settings		 Hue
			 Saturation
			 Clipping
			 Gain
			 Black Level
			 6 Colors
 Color Reset	"3-6. Reset to default" (page 33)		
Color (CAL Mode)* <sup>2</sup> 	 Target	"4-1. Setting the Color Mode for Executing SelfCalibration" (page 34)	
	 SelfCalibration		
	 Brightness		"4-4. Setting the calibration targets" (page 38)
	 White Point		
	 Color Gamut		
	 Gamut Settings		
	 Gamma		
	 Results	 Calibration Result	"4-6. Checking Adjustment Results" (page 40)
		 Ambient Light	
	 Color Reset	"3-6. Reset to default" (page 33)	

SelfCalibration 	Execute	"4-5. Executing SelfCalibration" (page 39)	
	Standard Mode	SelfCalibration	"4-1. Setting the Color Mode for Executing SelfCalibration" (page 34)
		Results	"4-6. Checking Adjustment Results" (page 40)
	Settings	Schedule	"4-3. Setting Calibration Schedule" (page 36)
		Clock Adjustment	"4-2. Setting Monitor Date and Time" (page 35)
Screen 	Screen Size	"To select screen size" (page 17)	
	Color Space	"2-4. Specifying Color Space" (page 26)	
	Input Range	"2-5. Expanding Signal Output Range" (page 27)	
	HDMI Settings <sup>*3</sup>	Noise Reduction	"2-6. Setting HDMI" (page 28)
		Film detection	
		Safe Area Marker	
		Safe Area Size	
		Border Color	
Power Manager 	Power Save	"6-1. Setting Power Save" (page 44)	
	Indicator brightness	"6-2. Adjusting Brightness of Front Button" (page 45)	
Menu Settings 	Language	"Selecting the Language" (page 30)	
	Orientation	"Setting Orientation" (page 30)	
	Menu Position	"To change adjustment menu display position" (page 31)	
Tools 	Input Selection	"5-2. Setting Input Signal Switching Procedure" (page 42)	
	Input Skip	"5-3. Skipping Unused Input Signals" (page 42)	
	Mode Skip	"3-2. Skipping Unused Display Modes" (page 31)	
	USB Selection	"5-4. Switching USB Port Automatically" (page 43)	
	Signal Info	"8-3. Showing Monitor Information" (page 52)	
	Monitor info		
	All Reset	"3-6. Reset to default" (page 33)	

\*1 Functions available for adjustment and setting in Standard Mode (page 19) are displayed.

\*2 Functions available for adjustment and setting in CAL Mode are displayed.

\*3 This function is available with HDMI signal input.

# Chapter 2 Adjusting Screens

## 2-1. Setting Resolution

### ● Compatible Resolutions/Formats

The monitor supports the following resolutions.

**When using PC signal input (DVI-D, DisplayPort, HDMI: PC)**

Resolution	Vertical scan frequency
640 × 480	60 Hz
720 × 400	70 Hz
800 × 600	60 Hz
1024 × 768	60 Hz
1280 × 960	60 Hz
1280 × 1024	60 Hz
1600 × 1200	60 Hz
1680 × 1050	60 Hz
1920 × 1080	60 Hz
1920 × 1200 *1	60 Hz

\*1 Recommended resolution

**When using Video signal input**

Formats	Vertical scan frequency	Resolution	Scan Type	DVI*3	Display Port*3	HDMI	
						Video*1,2	PC*3
640 × 480	60 Hz	640 × 480	Progressive	√	√	√	√
480i	60 Hz	720 × 480	Interlace	-	-	√	-
480p	60 Hz	720 × 480	Progressive	-	√	√	-
576i	50 Hz	720 × 576	Interlace	-	-	√	-
576p	50 Hz	720 × 576	Progressive	-	-	√	-
720p	50 Hz / 60 Hz	1280 × 720	Progressive	√	√	√	√
1080i	50 Hz / 60 Hz	1920 × 1080	Interlace	-	-	√	-
1080p	24 Hz / 25 Hz / 30 Hz / 50 Hz / 60 Hz	1920 × 1080	Progressive	√	√	√	√

\*1 YUV data input is supported.

\*2 To display video signals by HDMI signal input, you must change the monitor settings beforehand (see “[To switch signal formats \(Only for DisplayPort or HDMI signal input\)](#)” (page 16)).

\*3 The output device must be defined. Refer to the User’s Manual of the output device for further details.

## ● To switch signal formats (Only for DisplayPort or HDMI signal input)

The monitor's displayable resolution can be changed. To display video signals when using HDMI signal input, set to "Video".

### **Setting Range**

- DisplayPort: "RGB" / "RGB/YUV"
- HDMI: "Video" / "PC"

### **Procedure**

1. Press  $\odot$  to turn off the monitor.
2. Holding MODE down, press  $\odot$  for at least two seconds to turn on the monitor.  
The "Optional Settings" menu appears.
3. Choose "Signal Selection" from "Optional Settings", and press ENTER.
4. Choose the input signal to set with  $\blacktriangle$  or  $\blacktriangledown$ , and press ENTER.
5. Select "Signal Format" with the selected input signal and press ENTER.
6. Switch the signal format with  $\blacktriangle$  or  $\blacktriangledown$ .
7. Select "Finish" with  $\blacktriangle$  or  $\blacktriangledown$ .
8. Press ENTER.

## ● To set the display resolution for the OS

When you connect the monitor to the PC and find that the resolution is improper, or when you want to change the resolution, follow the procedure below.

### **Windows 10**

1. Right-click the mouse anywhere on the desktop except on icons.
2. From the displayed menu, click "Display settings".
3. In the "Customize Display" dialog box, click "Advanced Settings".
4. Select the monitor, and select the resolution from the "Resolution" pull-down menu.
5. Click "Apply".
6. When a confirmation dialog box appears, click "Keep changes".

### **Windows 8.1 / Windows 7**

1. For Windows 8.1, click the "Desktop" tile on the Start Screen to display the desktop.
2. Right-click anywhere on the desktop except for on icons.
3. From the displayed menu, click "Screen resolution".
4. Select a monitor, then choose a resolution from the "Resolution" pull-down menu.
5. Click "OK".
6. When a confirmation dialog box is displayed, click "Keep changes".

---

#### **Note**

- If you want to change the size of displayed characters and other items, select "Display" from Control Panel and change the zoom percentage.
-



## OS X Mountain Lion (10.8) or later

1. Select "System Preferences" from the Apple menu.
2. When the "System Preferences" dialog box is displayed, click "Displays". (For OS X Mountain Lion (10.8), click "Displays" for "Hardware".)
3. In the displayed dialog box, select the "Display" tab and select "Change" in the "Resolutions" field.
4. Select the desired resolution from the list of possible resolution settings. If the desired resolution is not displayed in the list, hold down the Option key and select "Change".
5. Your selection will be reflected immediately. When you are satisfied with the selected resolution, close the window.

## Mac OS X 10.7

1. Select "System Preferences" from the Apple menu.
2. When the "System Preferences" dialog box is displayed, click "Displays" for "Hardware".
3. In the displayed dialog box, select the "Display" tab and select the resolution in the "Resolutions" field.
4. Your selection will be reflected immediately. When you are satisfied with the selected resolution, close the window.

### ● To select screen size

The image with the resolution other than the recommended resolution is displayed in full screen automatically. You can change the screen size by using the "Screen Size" function from "Screen".

### When using PC signal input

Setting	Function
Full	Displays an image in full screen. Images are distorted in some cases because the vertical rate is not equal to the horizontal rate.
Enlarged	As far as possible, images are enlarged to full screen without changing the aspect ratio. Blank horizontal or vertical borders may appear to maintain aspect ratio.
Normal	Displays images with the specified resolution.

Example: Image size 1280 × 1024

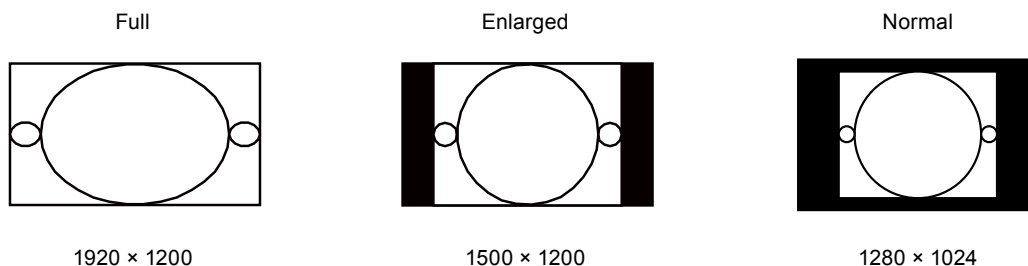

### **Procedure**

1. Choose "Screen" from the Adjustment menu, and press ENTER.
2. Choose "Screen Size" from "Screen", and press ENTER.
3. Select "Full", "Enlarged", or "Normal" with ▲ or ▼.
4. Press ENTER after completing the setting.

## When using video signal input

### ● When displaying HD signals (720p, 1080i, 1080p)

Setting	Function
Enlarged	As far as possible, images are enlarged to full screen without changing the aspect ratio. Blank borders may appear at the top and bottom of the screen to maintain the aspect ratio.
Dot by Dot	Displays images with the specified resolution.

Example: 720p

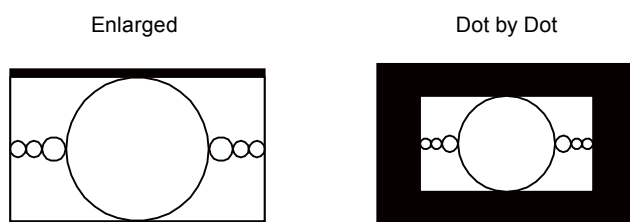

#### **Procedure**

1. Choose "Screen" from the Adjustment menu, and press ENTER.
2. Choose "Screen Size" from "Screen", and press ENTER.
3. Select "Enlarged", or "Dot by Dot" with ▼ or ▲.
4. Press ENTER after completing the setting.

### ● When displaying SD signals (640 × 480, 480i, 480p, 576i, 576p)

Setting	Function
Auto	The monitor automatically changes the screen size according to the aspect ratio sent from the auto input signal.
4:3	Displays images in a 4:3 format screen. Black bars appear on both sides of the screen. 16:9 images are horizontally compressed.
Letter Box	Displays 16:9 letterboxed images in full screen. Images other than the letterboxed ones are partly cut on top and bottom.
16:9	Displays the entire 16:9 image in full screen. Black bars appear on the top and bottom of the screen. 4:3 images are horizontally expanded.

Example: 480i/480p (16:9)

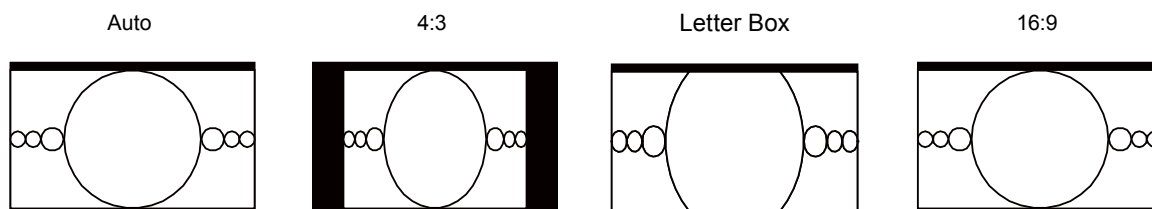

#### **Procedure**

1. Choose "Screen" from the Adjustment menu, and press ENTER.
2. Choose "Screen Size" from "Screen", and press ENTER.
3. Select "Auto", "4:3", "Letter Box", or "16:9" with ▲ or ▼.
4. Press ENTER after completing the setting.

## 2-2. Selecting the display mode (color mode)

This function allows easy selection of a desired mode according to monitor application.

### ● Display Modes

Mode	Purpose
Standard Mode	Adjust color using the monitor's Adjustment menu.
1-Custom	Available for the color settings according to your preference.
2-Adobe®RGB	Suitable for color matching with Adobe®RGB compatible peripherals.
3-sRGB	Suitable for color matching with sRGB compatible peripherals.
4-EBU	Suitable for reproducing the color gamut and gamma as defined in the EBU (European Broadcasting Union) standards.
5-REC709	Suitable for reproducing the color gamut and gamma as defined in the ITU-R Rec. 709 standard.
6-SMPTE-C	Suitable for reproducing the color gamut and gamma as defined in the SMPTE-C standard.
7-DCI	Suitable for reproducing the color gamut and gamma as defined in the DCI standard.
CAL Mode	Adjust the monitor's color using software.
8-CAL1	Displays the screen adjusted by the Color Management Software "ColorNavigator 6" and SelfCalibration.
9-CAL2	
10-CAL3	

#### Attention

- Avoid adjusting the screen or color while using ColorNavigator 6.

#### Procedure

1. Press any button (except  $\text{⏻}$ ).  
The guide is displayed.
2. Press MODE.  
The mode menu appears at the bottom left of the screen.

Example

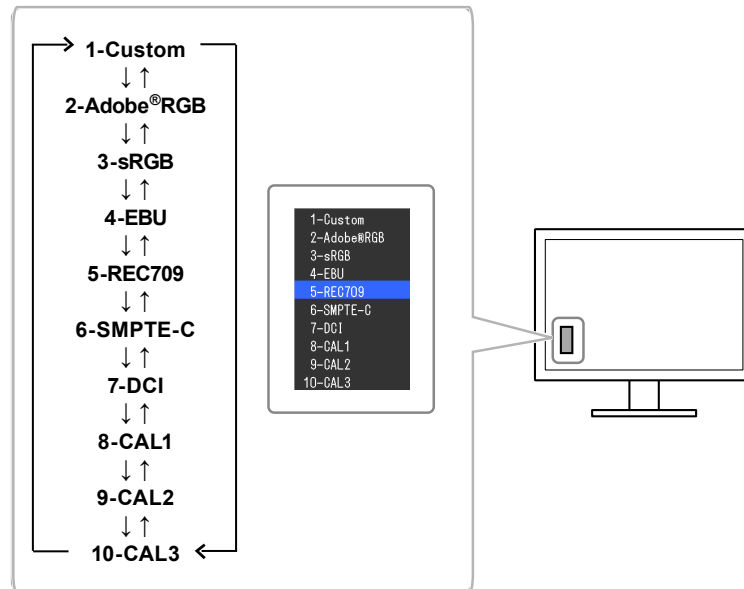

3. The mode among the list is highlighted in turn each time MODE is pressed.  
You can switch the mode with  $\blacktriangle$  or  $\blacktriangledown$  while the mode menu is displayed.

---

**Note**

- The Adjustment menu and the Mode menu cannot be displayed at the same time.
  - You can disable a specific mode to be selected. For more information, see “3-2. Skipping Unused Display Modes” (page 31).
  - The adjustment result of ColorNavigator 6 is reflected in each of the following modes, depending on the connector used for connecting the monitor and PC.
    - CAL1: DVI
    - CAL2: DisplayPort
    - CAL3: HDMI
- 

## 2-3. Adjusting the Color

---

When displaying in Standard Mode, the “Color” menu of the Adjustment menu allows you to set and save independent color adjustments for each mode.

---

**Attention**

- It takes about 3 minutes (under our measurement conditions) for the performance of electrical parts to stabilize. Please wait 3 minutes or more after the monitor has been turned on before adjusting the monitor.
  - The same image may be seen in different colors on multiple monitors due to their monitor-specific characteristics. Make fine color adjustment visually when matching colors on multiple monitors.
- 

**Note**

- Use the adjustment criteria shown in “cd/m<sup>2</sup>”, “K” and “%” as a guide.
- 

### ● To adjust brightness

The screen brightness is adjusted by changing the brightness of the backlight (light source from the LCD back panel).

**Setting Range**

40 cd/m<sup>2</sup> to 400 cd/m<sup>2</sup>

**Procedure**

1. Press any button (except  $\odot$ ).  
The guide is displayed.
  2. Press  $\blacktriangle$  or  $\blacktriangledown$ .  
The Brightness menu appears.
  3. Use  $\blacktriangle$  or  $\blacktriangledown$  for adjustment.
  4. Press ENTER after completing the setting.
- 

**Attention**

- If the entered value cannot be set, the value will appear in magenta. In such a case, change the value.
- 

**Note**

- Alternatively, you can use “Brightness” under “Color” in the Adjustment menu to adjust it.
-

## ● To adjust the temperature

The color temperature can be adjusted.

The color temperature is used to express the hue of “white” and/or “black” by a numerical value.

The value is expressed in “K” (Kelvin).

The screen becomes reddish at a low color temperature, and bluish at a high color temperature, like the temperature of a flame. The gain preset values are set for each color temperature setting value.

Setting	Purpose
4000K - 10000K	Specify color temperature in units of 100 K.
Native	The original color of the monitor (Gain: 100% for each RGB) is displayed.
Adobe®RGB	Change to color temperature in conformance with Adobe®RGB.
sRGB	Change to color temperature in conformance with sRGB.
EBU	Change to color temperature in conformance with EBU.
REC709	Change to color temperature in conformance with REC709.
REC1886	Change to color temperature in conformance with REC1886.
SMPTE-C	Change to color temperature in conformance with SMPTE-C.
DCI	Change to color temperature in conformance with DCI.
User	Displayed when gain is changed.

### **Procedure**

1. Choose “Color” from the Adjustment menu, and press ENTER.
2. Choose “Temperature” from “Color”, and press ENTER.
3. Use ▲ or ▼ for adjustment.
4. Press ENTER after completing the setting.

---

#### **Note**

- “Gain” allows you to perform more advanced adjustment (see [“Adjusting Gain” \(page 25\)](#)).
-

## ● To adjust gamma

Gamma can be adjusted. The brightness of the monitor varies depending on the input signal, however, the variation rate is not simply proportional to the input signal. The control performed to keep the balance between the input signal and the brightness of the monitor is called “Gamma correction”.

Setting	Purpose
1.6 to 2.7	Set the gamma value.
Adobe®RGB	Set the gamma curve defined by Adobe®RGB.
sRGB	Set the gamma curve defined by sRGB.
EBU	Set the gamma curve defined by EBU.
REC709	Set the gamma curve defined by REC709.
REC1886	Set the gamma curve defined by REC1886.
SMPTE-C	Set the gamma curve defined by SMPTE-C.
DCI	Set the gamma curve defined by DCI.

### Procedure

1. Choose “Color” from the Adjustment menu, and press ENTER.
2. Choose “Gamma” from “Color”, and press ENTER.
3. Use ▲ or ▼ for adjustment.
4. Press ENTER after completing the setting.

#### Note

- The gamma curve can be adjusted to L\* by using SelfCalibration or ColorNavigator 6. For details, see “4-4. Setting the calibration targets” (page 38) or the ColorNavigator 6 User's Manual (stored on the CD-ROM).
- L\* is a gamma curve defined in CIE1976 that is perceptually uniform.

## ● To set color gamut

Set the color reproduction area (color gamut). “Color gamut” is the range of colors that devices such as monitors, digital cameras and printers can express. Various standards are defined.

Setting	Purpose
Native	Display images in the monitor's original color gamut.
Adobe®RGB	Display images in the color gamut defined by Adobe®RGB.
sRGB	Display images in the color gamut defined by sRGB.
EBU	Display images in the color gamut defined by EBU.
REC709	Display images in the color gamut defined by REC709.
REC1886	Display images in the color gamut defined by REC1886.
SMPTE-C	Display images in the color gamut defined by SMPTE-C.
DCI	Display images in the color gamut defined by DCI.

### Procedure

1. Choose “Color” from the Adjustment menu, and press ENTER.
2. Choose “Color Gamut” from “Color”, and press ENTER.
3. Use ▲ or ▼ for adjustment.
4. Press ENTER after completing the setting.

#### Note

- The method of displaying colors outside the monitor's displayable range within the defined color gamut can be set. For details, see “To set clipping” (page 24).

## ● To perform advanced adjustments

Make further advanced color adjustments.

### To adjust hue

The hue can be adjusted.

#### **Setting Range**

-100 to 100

#### **Procedure**

1. Choose “Color” from the Adjustment menu, and press ENTER.
2. Choose “Advanced Settings” from “Color”, and press ENTER.
3. Choose “Hue”, and press ENTER.
4. Use ▲ or ▼ for adjustment.
5. Press ENTER after completing the setting.

---

#### **Attention**

- After this adjustment, some color gradations may not be displayed.
- 

### Adjusting Saturation

The color saturation can be adjusted.

#### **Setting Range**

-100 to 100

#### **Procedure**

1. Choose “Color” from the Adjustment menu, and press ENTER.
2. Choose “Advanced Settings” from “Color”, and press ENTER.
3. Choose “Saturation”, and press ENTER.
4. Use ▲ or ▼ for adjustment.
5. Press ENTER after completing the setting.

---

#### **Attention**

- After this adjustment, some color gradations may not be displayed.
- 

#### **Note**

- The minimum value (-100) changes the screen to monochrome.
-

## To set clipping

The method of displaying colors outside the monitor's displayable range within the color gamut set under "To set color gamut" (page 22) can be set.

### Procedure

1. Choose "Color" from the Adjustment menu, and press ENTER.
2. Choose "Advanced Settings" from "Color", and press ENTER.
3. Choose "Clipping", and press ENTER.
4. Select "On" or "Off" with ▲ or ▼.

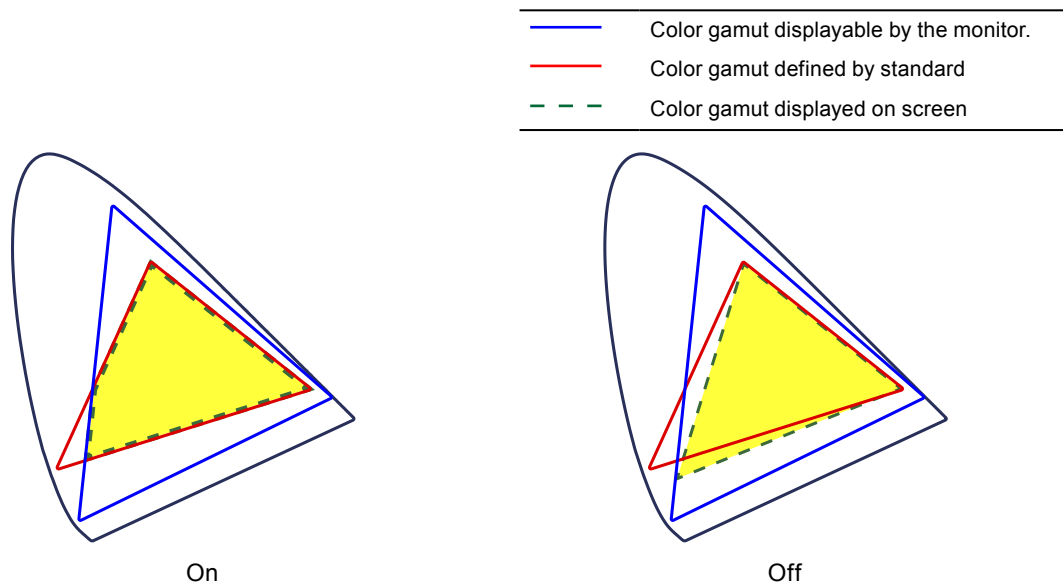

The range of colors that are displayable on the monitor will be accurately displayed in accordance with the standard. Colors outside the displayable range will be saturated.

Displays colors with priority on the color gradation rather than the color accuracy. The vertices of the color gamut defined in the standard move to a range that can be displayed by the monitor. This allows the closest colors displayable by the monitor to be displayed.

#### Attention

- This is a conceptual diagram, and does not display the actual color gamut of the monitor.

5. Press ENTER to exit.

#### Attention

- This setting will be disabled if "Native" is selected at "To set color gamut" (page 22).



## Adjusting Gain

The brightness of each color component red, green, and blue is called Gain. You can change the hue of “white” by adjusting gain.

### Setting Range

0% to 100%

### Procedure

1. Choose “Color” from the Adjustment menu, and press ENTER.
2. Choose “Advanced Settings” from “Color”, and press ENTER.
3. Choose “Gain”, and press ENTER.
4. Choose the color for adjustment from “Red”, “Green”, and “Blue”, and press ENTER.
5. Use ▲ or ▼ for adjustment.
6. Press ENTER after completing the setting.

---

### Attention

- After this adjustment, some color gradations may not be displayed.

### Note

- The “Temperature” setting invalidates this setting.
  - The value of gain changes with that of color temperature.
  - When gain is changed, the color temperature is changed to “User”.
- 

## To adjust the brightness and color of black

You can adjust the brightness and chromaticity of black by adjusting the black level of red, green, and blue respectively. Please use a black test pattern or background for adjustment of the black level.

### Adjustable Range

0% to 100%

### Procedure

1. Choose “Color” from the Adjustment menu, and press ENTER.
2. Choose “Advanced Settings” from “Color”, and press ENTER.
3. Choose “Black Level”, and press ENTER.
4. Choose the color for adjustment from “Red”, “Green”, and “Blue”, and press ENTER.
5. Use ▲ or ▼ for adjustment.
6. Press ENTER after completing the setting.

---

### Note

- To further darken the black when the value of the black level is 0, lower the brightness value.
-

## To adjust 6 Colors

The hue, saturation and lightness can be adjusted for each of six colors: Magenta, Red, Yellow, Green, Cyan, and Blue.

### Adjustable Range

-100 to 100

### Procedure

1. Choose “Color” from the Adjustment menu, and press ENTER.
2. Choose “Advanced Settings” from “Color”, and press ENTER.
3. Choose “6 Colors”, and press ENTER.
4. Choose the color for adjustment from “Magenta”, “Red”, “Yellow”, “Green”, “Cyan”, and “Blue”, and press ENTER.
5. Select “Hue”, “Saturation” or “Lightness”, and press ENTER.
6. Use ▲ or ▼ for adjustment.
7. Press ENTER after completing the setting.

## 2-4. Specifying Color Space

The color space of the input signal can be specified. Set to other than “Auto” if this product cannot display correct color.

Setting	Function
Auto	Identifies the color space of the input signal automatically.
YUV 4:2:2	Converts the color space of the input signal to a YUV 4:2:2 format.
YUV 4:4:4	Converts the color space of the input signal to a YUV 4:4:4 format.
RGB	Converts the color space of the input signal to an RGB format.

### Procedure

1. Choose “Screen” from the Adjustment menu, and press ENTER.
2. Choose “Color Space” from “Screen”, and press ENTER.
3. Select “Auto”, “YUV 4:2:2”, “YUV 4:4:4”, or “RGB” with ▲ or ▼.
4. Press ENTER after completing the setting.

### Attention

- This setting may be required when a DVI device is connected to the monitor via the HDMI connector port using a DVI-HDMI conversion connector.
- Even if “Auto” is set, correct color might not be displayed.

### Note

- The color space at the DVI input is converted to an RGB format.
- See “2-5. Expanding Signal Output Range” (page 27) to set the range of input signals.

## 2-5. Expanding Signal Output Range

Depending on the external device, the black and white levels in the video signal output to the monitor may be restricted. If the signal is displayed on the monitor in its restricted form, the blacks will be faint, the whites dull, and contrast will be reduced. The brightness range of such signals can be extended to match the actual contrast ratio of the monitor.

Setting	Function
Auto	The monitor automatically recognizes the brightness range of input signals and displays images appropriately.
Full	The input signal brightness range is not extended.
109% white	The brightness range of the input signal is extended from 16–254 (10-bit: 64–1019) to 0–255 (10-bit: 0–1023) for display.
Limited	The brightness range of the input signal is extended from 16–235 (10-bit: 64–940) to 0–255 (10-bit: 0–1023) for display.

### Procedure

1. Choose “Screen” from the Adjustment menu, and press ENTER.
2. Choose “Input Range” from “Screen”, and press ENTER.
3. Select “Auto”, “Full”, “109% white”, or “Limited” with ▲ or ▼.

---

### Attention

- When the DVI signal is input, “Auto” cannot be selected.
- 

4. Press ENTER after completing the setting.

## 2-6. Setting HDMI

---

### ● To reduce noise

The fine noise that occurs in dark areas of an image can be reduced. Use this function to reduce noise and roughness in images.

#### **Procedure**

1. Choose “Screen” from the Adjustment menu, and press ENTER.
2. Choose “HDMI Settings” from “Screen”, and press ENTER.
3. Choose “Noise Reduction”, and press ENTER.
4. Select “On” or “Off” using ▲ or ▼.
5. Press ENTER after completing the setting.

---

#### **Attention**

- Using the Noise Reduction function may lead to deterioration of fine images.
- 

### ● To select how to display interlace signal

The display method can be selected for displaying the interlace signal.

### To identify video images automatically and convert them to suitable images

Signals of 24 frames or 30 frames per second for images such as movies, computer graphics, and animations are automatically identified and the most suitable images are displayed.

#### **Procedure**

1. Choose “Screen” from the Adjustment menu, and press ENTER.
2. Choose “HDMI Settings” from “Screen”, and press ENTER.
3. Choose “Film Detection”, and press ENTER.
4. Select “On” or “Off” using ▲ or ▼.
5. Press ENTER after completing the setting.

---

#### **Attention**

- If distorted images are displayed when “Film Detection” is “On”, set “Film Detection” to “Off”.
-

## ● To set safe area

The “safe area” is an area in which images can be displayed on any display device. This function displays the safe area frame during for instance video editing, to enable positioning while confirming at a glance that subtitles and menu windows come within the safe area.

### To show or hide

Select whether or not to display the safe area.

#### **Procedure**

1. Choose “Screen” from the Adjustment menu, and press ENTER.
2. Choose “HDMI Settings” from “Screen”, and press ENTER.
3. Choose “Safe Area Marker”, and press ENTER .
4. Select “On” or “Off” using ▲ or ▼.
5. Press ENTER after completing the setting.

### To set safe area size

The size of the safe area can be set.

#### **Adjustable Range**

80% to 99%

#### **Procedure**

1. Choose “Screen” from the Adjustment menu, and press ENTER.
2. Choose “HDMI Settings” from “Screen”, and press ENTER.
3. Choose “Safe Area Size”, and press ENTER.
4. The size of the safe area is set using ▲ or ▼.
5. Press ENTER after completing the setting.

### To set safe area frame color

#### **Procedure**

1. Choose “Screen” from the Adjustment menu, and press ENTER.
2. Choose “HDMI Settings” from “Screen”, and press ENTER.
3. Choose “Border Color”, and press ENTER.
4. Choose and set the color for the safety area from “White”, “Red”, “Green”, “Blue”, “Cyan”, “Magenta”, and “Yellow”.
5. Press ENTER after completing the setting.

# Chapter 3 Setting the Monitor

## 3-1. Setting Adjustment Menu

The language, orientation, and display position of the Adjustment menu can be set.

### ● Selecting the Language

This function allows you to select a language for the Adjustment menu and messages.

#### **Selectable languages**

English/German/French/Spanish/Italian/Swedish/Japanese/Simplified Chinese/Traditional Chinese

#### **Procedure**

1. Choose “Menu Settings” from the Adjustment menu, and press ENTER.
2. Choose “Language” from “Menu Settings”, and press ENTER.
3. Select a language using ▲ or ▼.
4. Press ENTER after completing the setting.

### ● Setting Orientation

This function allows you to change the orientation of the Adjustment menu.

#### **Procedure**

1. Choose “Menu Settings” from the Adjustment menu, and press ENTER.
2. Choose “Orientation” from “Menu Settings”, and press ENTER.
3. Select “Landscape” or “Portrait” using ▲ or ▼.
4. Press ENTER after completing the setting.
5. When selecting “Portrait”, turn the monitor screen 90° in clockwise direction.

#### **Attention**

- Make sure that the cables are correctly connected.
- Before turning the monitor, make sure to raise the screen to its uppermost position of the stand and tilt the screen upward.

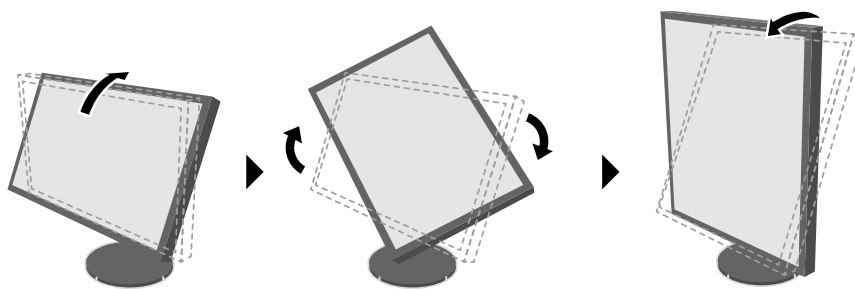

#### **Note**

- When using the monitor screen in a portrait position, the graphics board supporting portrait display is required. When placing the monitor in a portrait position, settings of your graphics board need to be changed. Refer to the User's Manual of the graphics board for details.

## ● To change adjustment menu display position

You can change the display position of the Adjustment menu.

### **Procedure**

1. Choose “Menu Settings” from the Adjustment menu, and press ENTER.
2. Choose “Menu Position” from “Menu Settings”, and press ENTER.
3. Choose the position using ▲ or ▼.
4. Press ENTER after completing the setting.

## 3-2. Skipping Unused Display Modes

When selecting a mode, you can skip particular modes. This setting is suitable when you are using limited display modes and you do not want to change the customized display state.

### **Procedure**

1. Choose “Tools” from the Adjustment menu, and press ENTER.
2. Choose “Mode Skip” from “Tools”, and press ENTER.
3. Use ▲ or ▼ to select the mode to change, and press ENTER.
4. Select “-” or “Skip” using ▲ or ▼.
5. Press ENTER after completing the setting.

---

### **Attention**

- You cannot set all modes to “Skip”.

---

### **Note**

- In the factory settings, available CAL modes differ depending on input signal.
- 

## 3-3. Showing and Hiding the EIZO Logo

When the monitor is turned on, the EIZO logo appears on the screen. You can choose to show or hide the display of the EIZO logo.

### **Procedure**

1. Press ⏻ to turn off the monitor.
2. Holding MODE down, press ⏻ for at least two seconds to turn on the monitor.  
The “Optional Settings” menu appears.
3. Choose “Logo” from “Optional Settings”, and press ENTER.
4. Select “On” or “Off” using ▲ or ▼, and press ENTER.
5. Select “Apply” using ▲ or ▼.
6. Press ENTER.

## 3-4. Locking Operation Buttons

This function allows you to lock the settings status to prevent them from being changed.

### Procedure

1. Press  $\mathcal{O}$  to turn off the monitor.
2. Holding MODE down, press  $\mathcal{O}$  for at least two seconds to turn on the monitor.  
The “Optional Settings” menu appears.
3. Choose “Key Lock” from “Optional Settings”, and press ENTER.
4. Choose “Off”, “Menu”, or “All” using  $\blacktriangle$  or  $\blacktriangledown$ , and press ENTER.

Setting	Buttons that can be locked
Off (Default setting)	None (All buttons are enabled)
Menu	ENTER button
All	All buttons excluding $\mathcal{O}$

5. Select “Apply” using  $\blacktriangle$  or  $\blacktriangledown$ .
6. Press ENTER.

## 3-5. Changing DUE (Digital Uniformity Equalizer) Setting

This product is equipped with a Digital Uniformity Equalizer (DUE) function that reduces display unevenness. This DUE setting can be changed.

Setting	Function
Brightness	Prioritizes high brightness and high contrast ratio.
Uniformity	Prioritizes reduction of display unevenness.

### Attention

- When changing the DUE setting, the monitor whose display is adjusted must be re-calibrated. Perform the target calibration and correlation again using ColorNavigator 6. For details, refer to the ColorNavigator 6 User's Manual (stored on the CD-ROM).
- Re-calibration is also necessary when using SelfCalibration ([page 34](#)) to calibrate the screen.

### Procedure

1. Press  $\mathcal{O}$  to turn off the monitor.
2. Holding MODE down, press  $\mathcal{O}$  for at least two seconds to turn on the monitor.  
The “Optional Settings” menu appears.
3. Choose “DUE Priority” from “Optional Settings”, and press ENTER.
4. Select “Uniformity” or “Brightness” using  $\blacktriangle$  or  $\blacktriangledown$ , and press ENTER.
5. Select “Apply” using  $\blacktriangle$  or  $\blacktriangledown$ .
6. Press ENTER.



## 3-6. Reset to default

---

The setting values are reset to the default settings.

---

**Attention**

- After resetting, you cannot undo the operation.

---

**Note**

- Regarding the default settings, see [“Main Default Settings” \(page 54\)](#).
- 

### ● Resetting the color adjustments

Only the color adjustment value for the currently selected mode can be reset to the default settings.

**Procedure**

1. Choose “Color” from the Adjustment menu, and press ENTER.
2. Choose “Color Reset” from “Color”, and press ENTER.
3. Select “Execute” using ▲ or ▼.
4. Press ENTER.

### ● Resetting all adjustments to defaults

This function resets all adjustments to the default settings (except the “Optional Settings” menu and “USB Selection”.)

**Procedure**

1. Choose “Tools” from the Adjustment menu, and press ENTER.
2. Choose “All Reset” from “Tools”, and press ENTER.
3. Select “Execute” using ▲ or ▼.
4. Press ENTER.

# Chapter 4 SelfCalibration

This product is equipped with a built-in calibration sensor. By setting the calibration targets and execution schedule in advance, the calibration sensor automatically operates and regularly calibrates the monitor.

This automatic calibration function is called “SelfCalibration”.

The adjustment content of SelfCalibration differs depending on the color mode that is executed.

- Calibration Mode (CAL mode: CAL1 / CAL2 / CAL3):
  - When performing SelfCalibration on the monitor itself, calibrate the monitor to match the set targets.
  - When using ColorNavigator 6, use ColorNavigator 6 and a measurement device to maintain the calibrated state of the monitor.
- Standard Mode (color mode excluding CAL1 / CAL2 / CAL3): the monitor's color reproduction gamut is updated and each display mode in Standard Mode is adjusted as follows:
  - The temperature is adjusted so that it is as close as possible to the specified value.
  - The gamut values are adjusted so that they are close to each specified value.
  - Information on brightness is updated.

You can set the calibration targets and execution schedule in the monitor's Adjustment menu or in ColorNavigator 6.

In this section, the settings for executing SelfCalibration on the monitor as a standalone unit are explained.

For the settings in ColorNavigator 6, refer to the ColorNavigator 6 User's Manual (stored on the CD-ROM).

---

## Note

- The measurement results from the built-in calibration sensor can be correlated with the measurement results from the measurement device you use. For details, refer to the ColorNavigator 6 User's Manual (stored on the CD-ROM).
  - When the main power of the monitor is on, SelfCalibration can also be performed when there are no PC signals being input.
- 

## 4-1. Setting the Color Mode for Executing SelfCalibration

### ● CAL mode

The Cal Mode setting is performed in “Color” of the Adjustment menu.

---

## Note

- Multiple CAL modes can be enabled for one input signal. For more information, see [“3-2. Skipping Unused Display Modes” \(page 31\)](#).
- 

## Procedure

1. Switch to desired color mode.
2. Choose “Color” from the Adjustment menu, and press ENTER.
3. Choose “Target” from “Color”, and press ENTER.  
The target setting window appears.
4. Choose “SelfCalibration” from the “Target” menu, and press ENTER.
5. Select “On” or “Off” with ▲ or ▼, and press ENTER.
6. Press ENTER to exit.

## ● Standard Mode

The Standard Mode setting is performed in “SelfCalibration” of the Adjustment menu.

### **Procedure**

1. Choose “SelfCalibration” from the Adjustment menu, and press ENTER.
2. Choose “Standard Mode” from “SelfCalibration”, and press ENTER.  
The Standard Mode adjustment menu appears.
3. Choose “SelfCalibration” from the “Standard Mode” menu, and press ENTER.
4. Select “On” or “Off” with ▲ or ▼, and press ENTER.
5. Press RETURN to exit.

## 4-2. Setting Monitor Date and Time

---

Set the monitor date and time.

---

### **Attention**

- If the main power supply is disconnected for an extended period of time, the clock may need resetting.

---

### **Note**

- When ColorNavigator 6 is started, the date and time are automatically set. For details, refer to the ColorNavigator 6 User's Manual (stored on the CD-ROM).
- 

### **Procedure**

1. Choose “SelfCalibration” from the Adjustment menu, and press ENTER.
2. Choose “Settings” from “SelfCalibration”, and press ENTER.
3. Choose “Clock Adjustment” from “Settings”, and press ENTER.
4. The Clock Adjustment menu appears.
5. Set date with ▲ or ▼, and press ENTER.
6. Set time with ▲ or ▼, and press ENTER.

## 4-3. Setting Calibration Schedule

Set the calibration schedule for SelfCalibration.

### Procedure

1. Choose "SelfCalibration" from the Adjustment menu, and press ENTER.
2. Choose "Settings" from "SelfCalibration", and press ENTER.
3. Choose "Schedule" from "Settings", and press ENTER.

The schedule setting menu appears.

4. Choose "Starting Time", and press ENTER.
5. Set the "Starting Time" with ▲ or ▼.

Select the timing to execute SelfCalibration upon reaching the time set in the schedule.

Setting	Function
Off	SelfCalibration is not executed.
Power Save	To be executed under any of the following conditions. <ul style="list-style-type: none"> <li>• When the monitor is in "Power Save" mode or power is off at the set time.</li> <li>• The monitor shifts to the power saving mode or the power is turned off when the time period set in the schedule has elapsed.</li> </ul>
Immediately	SelfCalibration is executed immediately at the set time.

Press ENTER after completing the setting.

6. Choose "Setting Type, and press ENTER.  
Select the method for setting the adjustment schedule.

Setting	Function	Setting Example
Type-1	Execute once in every few months.	Execute once a month on Wednesday at 1:00 AM of the first week.
Type-2	Execute once every few weeks.	Execute once every four weeks on Wednesday at 1:00 AM.
Type-3	Execute when the monitor usage time exceeds the set time.	Execute when the monitor usage time exceeded 200 hours.

Press ENTER after completing the setting.

7. Select the interval for execution.  
The setting details differ depending on the type of "Setting Type" set.

### Type-1

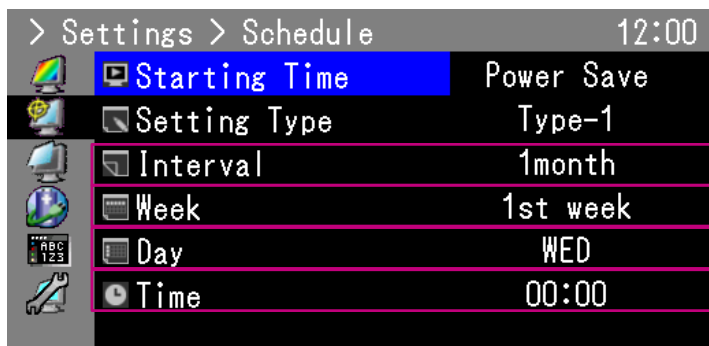

Set the interval between executions in months.  
Set within 1 month to 12 months.

Select the week of the month for execution. Choose between week 1 to week 5.

Select the day for execution. Select from SUN/MON/TUE/WED/THU/FRI and SAT.

Set the time at which SelfCalibration is executed.  
Set within 0:00 to 23:30.

### Attention

- If the fifth week is selected but the fifth week doesn't have the selected day, adjustment will be executed on the fourth week.

## Type-2

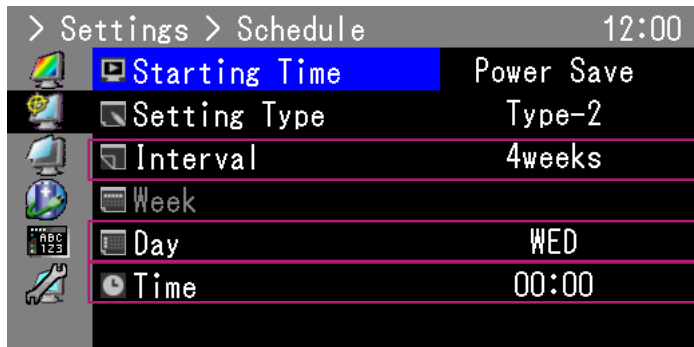

Set the interval between executions in weeks.  
Set within 1 week to 5 weeks.

Select the day for execution.  
Select from SUN/MON/TUE/WED/THU/FRI and SAT.

Set the time at which SelfCalibration is executed.  
Set within 0:00 to 23:30.

## Type-3

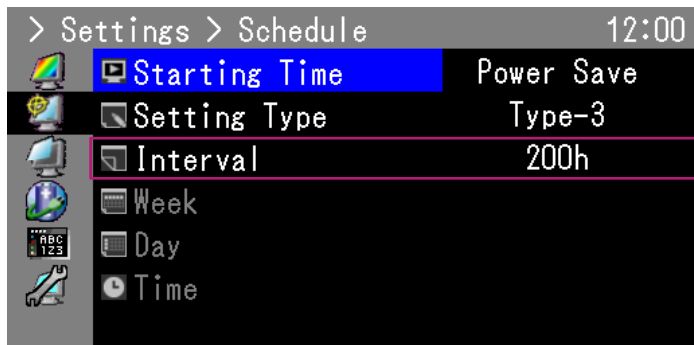

Set the number of hours of monitor usage to elapse until execution.  
Set within 50 to 500 hours.

Press ENTER to exit.

8. After completing all settings, press RETURN. This sets the calibration schedule.

---

### Note

- Upon reaching the set timing, the power indicator will blink in blue (quickly twice).
-

## 4-4. Setting the calibration targets

In CAL mode, white point, color gamut and gamma can be set as adjustment targets.

### Attention

- Adjustment targets will be applied only to the currently displayed CAL mode.

### Procedure

1. Choose “Color” from the Adjustment menu, and press ENTER.
2. Choose “Target” from “Color”, and press ENTER.  
The target setting window appears.
3. Choose “Brightness”, and press ENTER.
4. Set the target brightness with ▲ or ▼, and press ENTER.
5. Choose “White Point”, and press ENTER.

The white point setting window appears.

- When setting color coordinates, select “White(x)” and “White(y)” and press ENTER.  
Then set the respective values. Set within 0.2400 to 0.4500.
- To specify the color temperature, select “Temperature” and press ENTER.

Setting	Function
4000K - 10000K	Specify color temperature in units of 100 K.
Adobe®RGB	Change to color temperature in conformance with Adobe®RGB.
sRGB	Change to color temperature in conformance with sRGB.
EBU	Change to color temperature in conformance with EBU.
REC709	Change to color temperature in conformance with REC709.
REC1886	Change to color temperature in conformance with REC1886.
SMPTE-C	Change to color temperature in conformance with SMPTE-C.
DCI	Change to color temperature in conformance with DCI.

### Attention

- When color coordinates are changed, the color temperature is automatically changed to “User”.

Press ENTER after completing the setting.

6. Choose “Color Gamut”, and press ENTER.

The color gamut setting window appears. The color gamut defined by each standard can be selected.

Setting	Function
Native	Display images in the monitor’s original color gamut.
Adobe®RGB	Display images in the color gamut defined by Adobe®RGB.
sRGB	Display images in the color gamut defined by sRGB.
EBU	Display images in the color gamut defined by EBU.
REC709	Display images in the color gamut defined by REC709.
REC1886	Display images in the color gamut defined by REC1886.
SMPTE-C	Display images in the color gamut defined by SMPTE-C.
DCI	Display images in the color gamut defined by DCI.

### Attention

- To set a color gamut other than those specified by each standard, specify the color coordinates of each RGB color at “Gamut Settings”. The “Color Gamut” setting will automatically change to “User” at this time.
- Clipping can be set at “Gamut Settings”. For details on clipping, see (“To set clipping” (page 24)).

7. Choose “Gamma”, and press ENTER.

Setting	Function
1.6-2.7	Set the gamma value.
Adobe®RGB	Set the gamma curve defined by Adobe®RGB.
sRGB	Set the gamma curve defined by sRGB.
EBU	Set the gamma curve defined by EBU.
REC709	Set the gamma curve defined by REC709.
REC1886	Set the gamma curve defined by REC1886.
SMPTE-C	Set the gamma curve defined by SMPTE-C.
DCI	Set the gamma curve defined by DCI.
L*	Set the perceptually uniform gamma curve defined by CIE1976.

**Note**

- The color gradation adjustment results are reflected and automatically become “Fixed” when adjusted with ColorNavigator 6.

Press ENTER after completing the setting.

8. After completing all settings, press RETURN.

## 4-5. Executing SelfCalibration

SelfCalibration can be executed manually regardless of the schedule.

**Procedure**

1. Choose “SelfCalibration” from the Adjustment menu, and press ENTER.
2. Choose “Execute” from “SelfCalibration”, and press ENTER.

The built-in calibration sensor is activated, and SelfCalibration is executed.

**Attention**

- To execute SelfCalibration, it is necessary to set the calibration details. For more information, see “4-4. Setting the calibration targets” (page 38).
- After selecting “Execute”, warming up (after the power to the monitor is switched on, leaving the monitor on for a certain period of time until the display becomes stable) may be executed before the built-in calibration sensor comes out.

## 4-6. Checking Adjustment Results

---

The previous SelfCalibration results can be checked.

### ● To check adjustment results with CAL mode

#### **Procedure**

1. Choose “Color” from the Adjustment menu, and press ENTER.
2. Choose “Result” from “Color”, and press ENTER.
3. Choose “Calibration Result” from “Result”, and press ENTER.

The adjustment result window appears.

---

#### **Attention**

- The measurement results of the ambient light sensor are used to check the difference between the current environmental light level and the level of ambient light when SelfCalibration was executed, and are not reflected in the SelfCalibration results.

---

#### **Attention**

- If “Ambient Light” is selected, the current environmental light is also displayed.
  - If the environment in which the product is used is significantly different to the previous environment, the ambient light measurement results may vary substantially between the previous and current calibrations.
- 

### ● To check adjustment results with Standard Mode

#### **Procedure**

1. Choose “SelfCalibration” from the Adjustment menu, and press ENTER.
2. Choose “Standard Mode” from “SelfCalibration”, and press ENTER.
3. Choose “Result” from “Standard Mode”, and press ENTER.

The adjustment result window appears.

4. Choose “Ambient Light” from “Result”, and press ENTER.

The measurement result screen of ambient light is displayed.



# Chapter 5 Connecting Multiple External Devices

The product allows you to connect multiple external devices and switch between them for display.

## Connection examples

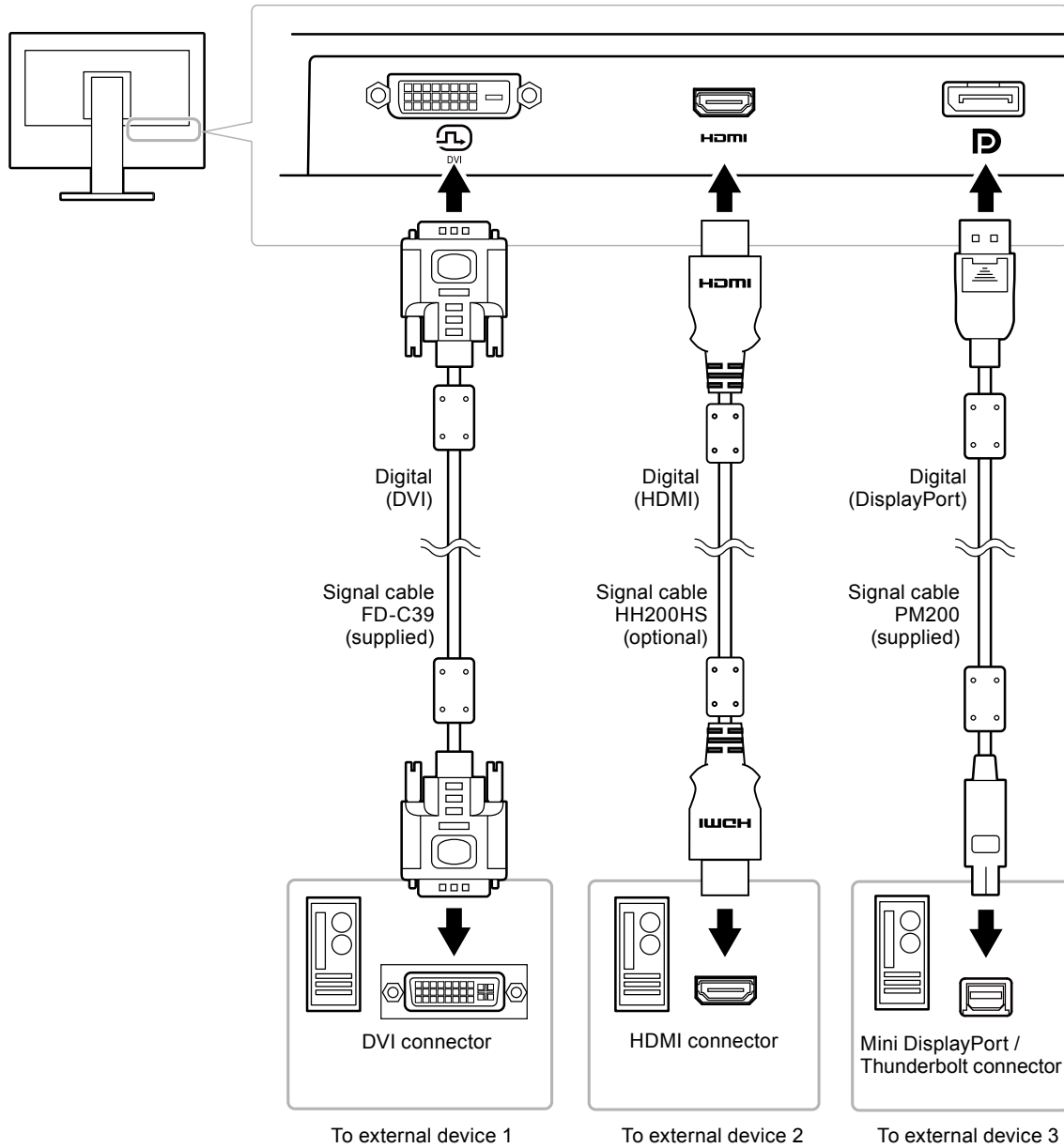

## 5-1. Switching among Input Signals

The input signal switches each time SIGNAL is pressed.

When the signal is switched, the active input port name appears at the top right corner of the screen.

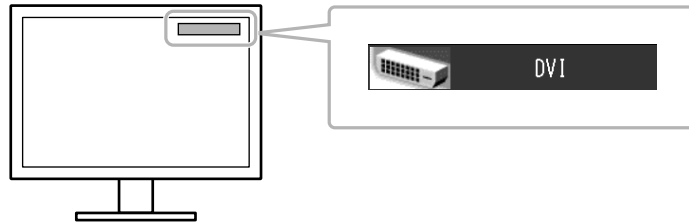

## 5-2. Setting Input Signal Switching Procedure

Setting	Function
Auto	The monitor automatically recognizes the connector through which signals are input and displays images on the screen accordingly. When an external device enters the power saving mode, the monitor automatically displays another signal.
Manual	The monitor displays the signal from the selected connector irrespective of whether there is signal input. Select the input signal for display using the SIGNAL operation button.

### Procedure

1. Choose "Tools" from the Adjustment menu, and press ENTER.
2. Choose "Input Selection" from "Tools", and press ENTER.
3. Select "Auto" or "Manual" using ▲ or ▼.
4. Press ENTER after completing the setting.

### Note

- When "Auto" is selected for "Input Selection", the monitor's power saving function works only when all external devices are in the power saving mode.

## 5-3. Skipping Unused Input Signals

This function allows skipping unneeded input signals when the input signals are switched.

### Procedure

1. Choose "Tools" from the Adjustment menu, and press ENTER.
2. Choose "Input Skip" from "Tools", and press ENTER.
3. Use ▲ or ▼ to select the input signal to change, and press ENTER.
4. Select "-" or "Skip" with ▲ or ▼.
5. Press ENTER after completing the setting.

### Note

- You cannot skip all input signals.

## 5-4. Switching USB Port Automatically

---

This function allows for linking the input signal and the USB upstream port when one monitor is connected to two PCs. This can switch the USB port automatically according to the switch of the input signal. To calibrate one monitor using two PCs, the USB cables do not need to be connected again. USB devices such as the mouse and keyboard connected to one monitor can be used with two PCs.

---

### **Attention**

- A cap is attached to USB-2 at shipment. Remove the cap when using USB-2.
- To switch between USB ports two USB cables are required. Ensure cables are available.
- If a storage device such as a USB thumb drive is connected to the monitor, remove the device before changing the setting. Otherwise, data may be lost or damaged.
- The key arrangement of the keyboard cannot be changed.

---

### **Note**

- When the “Input Selection” function is set to “Auto”, the USB port automatically switches according to the switch of the input signal.
  - The USB downstream port can be operated using the currently displayed PC.
- 

### **Procedure**

1. Choose “Tools” from the Adjustment menu, and press ENTER.
2. Choose “USB Selection” from “Tools”, and press ENTER.
3. Choose the input signal to set using ▲ or ▼, and press ENTER.
4. Select “USB-1” or “USB-2” using ▲ or ▼.
5. Press ENTER after completing the setting.

# Chapter 6 Power Saving Functions

## 6-1. Setting Power Save

This function allows you to specify whether to set the monitor in the power saving mode, depending on the state of an external device connected to it. When the monitor has shifted to the power saving mode, the images on the screen are not displayed.

### Attention

- When not using the monitor, you can turn off the main power supply or disconnect the power plug so that the power is cut completely.
- When the monitor is in power saving mode, or when the monitor is turned off, devices connected to the USB downstream port will still work. Therefore, power consumption of the monitor varies depending on the connected devices, even in the power saving mode.
- Five seconds before the monitor enters the power saving mode, it displays a preliminary message.

### Procedure

1. Choose “PowerManager” from the Adjustment menu, and press ENTER.
2. Choose “Power Save” from “PowerManager”, and press ENTER.
3. Select “On” or “Off” using ▲ or ▼.
4. Press ENTER after completing the setting.

### Power Saving System

#### When the external device connected is a PC

##### At DVI signal input

This monitor complies with the “DVI DMPM” standard.

##### At DisplayPort signal input

This monitor complies with the “DisplayPort Standard V1.1a”.

PC	Monitor	Power indicator
On	Operation mode	Blue
Power saving mode	Power saving mode	Orange

#### When the external device connected is not a PC

Ext. Device	Monitor	Power indicator
On	Operation mode	Blue
Power saving mode	Power saving mode	Orange

### Exiting power saving mode

If the monitor receives input, it automatically exits power saving mode and returns to the normal display mode.

## 6-2. Adjusting Brightness of Front Button

The brightness of the power button (blue) and the control button when the screen is displayed can be set. (Default setting: 4)

### **Procedure**

1. Choose “PowerManager” from the Adjustment menu, and press ENTER.
2. Choose “Indicator” from “PowerManager”, and press ENTER.
3. Select indicator brightness “Off” or in the range from 1 to 7 using ▲ or ▼ as desired.
4. Press ENTER after completing the setting.

## 6-3. Setting DisplayPort Power Save

If the PC is connected to the DisplayPort connector, and when the power is turned on or off or when the monitor recovers from power saving mode, window or icon positions may be shifted. In such cases, set this function to “Off”.

### **Procedure**

1. Press ⏻ to turn off the monitor.
2. Holding MODE down, press ⏻ for at least two seconds to turn on the monitor.  
The “Optional Settings” menu appears.
3. Choose “DP Power Save” from “Optional Settings”, and press ENTER.
4. Select “On” or “Off” using ▲ or ▼, and press ENTER.
5. Select “Apply” using ▲ or ▼.
6. Press ENTER.

# Chapter 7 Troubleshooting

## 7-1. No picture

Problem	Possible cause and remedy
<p><b>1. No picture</b></p> <ul style="list-style-type: none"> <li>Power indicator does not light up.</li> </ul> <hr/> <ul style="list-style-type: none"> <li>Power indicator is lighting blue.</li> </ul> <hr/> <ul style="list-style-type: none"> <li>Power indicator is lighting orange.</li> </ul> <hr/> <ul style="list-style-type: none"> <li>Power indicator is flashing orange and blue.</li> </ul>	<ul style="list-style-type: none"> <li>Check whether the power cord is connected properly.</li> <li>Turn on the main power switch on the rear side of the monitor.</li> <li>Press .</li> <li>Turn off the main power on the rear side of the monitor, and then turn it on again a few minutes later.</li> </ul> <hr/> <ul style="list-style-type: none"> <li>Increase "Brightness" and/or "Gain" in the Adjustment menu (see "2-3. Adjusting the Color" (page 20)).</li> </ul> <hr/> <ul style="list-style-type: none"> <li>Switch the input signal with SIGNAL.</li> <li>Operate the mouse or keyboard.</li> <li>Check whether the PC is turned on.</li> </ul> <hr/> <ul style="list-style-type: none"> <li>This problem may occur when a PC is connected via the DisplayPort connector. Connect via the signal cable specified by EIZO, turn off the monitor, and then turn it on again.</li> </ul>
<p><b>2. The message below appears.</b></p> <ul style="list-style-type: none"> <li>This message appears when no signal is input. Example:</li> </ul> <div data-bbox="274 1072 671 1341" data-label="Image"> </div> <hr/> <ul style="list-style-type: none"> <li>The message shows that the input signal is out of the frequency specification range. (Such signal frequency is displayed in magenta.) Example:</li> </ul> <div data-bbox="274 1487 671 1805" data-label="Image"> </div> <p>fD: Dot Clock fH: Horizontal Scan Frequency fV: Vertical scan frequency</p>	<p>This message appears when the signal is not input correctly even though the monitor is functioning properly.</p> <ul style="list-style-type: none"> <li>The message shown left may appear, because some PCs do not output the signal immediately after power-on.</li> <li>Check whether the PC is turned on.</li> <li>Check whether the signal cable is connected properly.</li> <li>Switch the input signal with SIGNAL.</li> </ul> <hr/> <ul style="list-style-type: none"> <li>Check whether the PC is configured to meet the resolution and vertical scan frequency requirements of the monitor (see "Compatible Resolutions/Formats" (page 15)).</li> <li>Reboot the PC.</li> <li>Change to the appropriate setting using the graphics board's utility. Refer to the User's Manual of the graphics board for details.</li> </ul>

## 7-2. Imaging problems

Problem	Possible cause and remedy
1. The screen is too bright or too dark.	<ul style="list-style-type: none"> <li>Use "Brightness" in the Adjustment menu to adjust it. (The LCD monitor backlight has a limited life span. When the screen becomes dark or begins to flicker, contact your local EIZO representative.)</li> </ul>
2. Characters are blurred.	<ul style="list-style-type: none"> <li>Check whether the PC is configured to meet the resolution and vertical scan frequency requirements of the monitor (see "<a href="#">Compatible Resolutions/Formats</a>" (page 15)).</li> </ul>
3. Afterimages appear	<ul style="list-style-type: none"> <li>Afterimages are particular to LCD monitors. Avoid displaying the same image for a long time.</li> <li>Use the screen saver or power saving function to avoid displaying the same image for extended periods of time.</li> </ul>
4. Green/red/blue/white dots or defective dots remain on the screen.	<ul style="list-style-type: none"> <li>This is due to LCD panel characteristics and not a malfunction.</li> </ul>
5. Interference patterns or pressure marks remain on the screen.	<ul style="list-style-type: none"> <li>Display a white or black image over the entire screen. The symptom may disappear.</li> </ul>
6. Noise appears on the screen.	<ul style="list-style-type: none"> <li>When entering the signals of HDCP, normal images may not be displayed immediately.</li> </ul>
7. (DisplayPort signal input) When you switch the power back on or return from power save mode, windows or icons have shifted position.	<ul style="list-style-type: none"> <li>In the Adjustment menu, set "DP Power Save" to "Off" (see "<a href="#">Compatible Resolutions/Formats</a>" (page 15)).</li> </ul>
8. (DisplayPort or HDMI input) The screen colors look strange.	<ul style="list-style-type: none"> <li>Use "Screen" - "Color Space" under the Adjustment menu to adjust it (see "<a href="#">2-4. Specifying Color Space</a>" (page 26)).</li> <li>For HDMI signal input, change the "Signal Format" setting (see "<a href="#">To switch signal formats (Only for DisplayPort or HDMI signal input)</a>" (page 16)).</li> </ul>
9. The image does not display on the entire screen.	<ul style="list-style-type: none"> <li>Change the "Screen Size" setting under the Adjustment menu (see "<a href="#">To select screen size</a>" (page 17)).</li> <li>For HDMI signal input, check whether "Signal Format" is set to "PC" in the Adjustment menu (see "<a href="#">To switch signal formats (Only for DisplayPort or HDMI signal input)</a>" (page 16)).</li> </ul>

## 7-3. Other problems

Problem	Possible cause and remedy
1. The Adjustment menu/Mode menu cannot be displayed	<ul style="list-style-type: none"><li>• Check whether the operation button lock function is on (see “3-4. Locking Operation Buttons” (page 32)).</li><li>• Operation buttons are locked when the main window of ColorNavigator 6 is displayed. Exit the software.</li></ul>
2. The monitor connected with the USB cable is not detected. / USB device connected to the monitor does not work.	<ul style="list-style-type: none"><li>• Check whether the USB cable is connected correctly (see “8-2. Making Use of USB (Universal Serial Bus)” (page 51)).</li><li>• Check the “USB Selection” settings under the Adjustment menu (see “5-4. Switching USB Port Automatically” (page 43)).</li><li>• Try changing to a different USB port on the PC.</li><li>• Try changing to a different USB port on the monitor.</li><li>• Reboot the PC.</li><li>• If the peripheral devices work correctly when the PC and peripheral devices are connected directly, please contact your local EIZO representative.</li><li>• Check whether the PC and OS are USB compliant. (For USB compliance of the respective devices, consult their manufacturers.)</li><li>• Check the PC’s BIOS setting for USB when using Windows. (Refer to the User’s Manual of the PC for details.)</li></ul>
3. Audio is not output.	<ul style="list-style-type: none"><li>• This monitor does not support the HDMI/DisplayPort audio signals.</li></ul>



## 7-4. Built-in calibration sensor and SelfCalibration problems

Problem	Possible cause and remedy
1. The built-in calibration sensor does not come out/stays out.	<ul style="list-style-type: none"> <li>Turn off the main power on the rear side of the monitor, wait for a few minutes before turning the power back on, and then execute SelfCalibration again.</li> </ul>
2. SelfCalibration cannot be executed.	<ul style="list-style-type: none"> <li>Check whether the date and time are set correctly (see "4-2. Setting Monitor Date and Time" (page 35)).</li> <li>Check whether the calibration schedule has been set (see "4-3. Setting Calibration Schedule" (page 36)).</li> <li>Check whether the calibration targets are set correctly (see "4-4. Setting the calibration targets" (page 38)).</li> <li>Set the SelfCalibration target using ColorNavigator 6.</li> </ul>
3. SelfCalibration failure	<ul style="list-style-type: none"> <li>Refer to the error code table.</li> </ul>

### Error Code Table

Error Code	Possible cause and remedy
0011	<ul style="list-style-type: none"> <li>Calibration cannot be performed because the target brightness is too low. Increase the target brightness, and then execute SelfCalibration again.</li> </ul>
0013	<ul style="list-style-type: none"> <li>There may be a problem with the target value setting. Recheck the target value of the Color Gamut.</li> <li>It is possible that measurement could not be performed correctly. <ul style="list-style-type: none"> <li>Ensure that the built-in calibration sensor is not exposed to strong light such as direct sunlight.</li> <li>Try executing correlation using ColorNavigator 6.</li> </ul> </li> </ul>
0014	<ul style="list-style-type: none"> <li>The target brightness may be too high. Lower the target brightness, and then execute SelfCalibration again.</li> <li>Calibration may have failed. Ensure that the built-in calibration sensor is not exposed to strong light such as direct sunlight, and then execute SelfCalibration again.</li> </ul>
0030 0032	<ul style="list-style-type: none"> <li>The built-in calibration sensor may have failed. Contact your local EIZO representative.</li> </ul>
0033	<ul style="list-style-type: none"> <li>It is possible that measurement could not be performed correctly. <ul style="list-style-type: none"> <li>Try executing correlation using ColorNavigator 6.</li> </ul> </li> </ul>
0034	<ul style="list-style-type: none"> <li>Measurement failed. Execute SelfCalibration again.</li> </ul>
0036	<ul style="list-style-type: none"> <li>There may be a problem with the target value setting. Recheck the target value of the Color Gamut.</li> <li>It is possible that measurement could not be performed correctly. <ul style="list-style-type: none"> <li>Ensure that the built-in calibration sensor is not exposed to strong light such as direct sunlight.</li> <li>Try executing correlation using ColorNavigator 6.</li> </ul> </li> </ul>
0037	<ul style="list-style-type: none"> <li>It is possible that measurement could not be performed correctly. <ul style="list-style-type: none"> <li>Try executing correlation using ColorNavigator 6.</li> </ul> </li> </ul>
0038 0039 0040 0041 0050	<ul style="list-style-type: none"> <li>The built-in calibration sensor may have failed. Contact your local EIZO representative</li> </ul>
0060 0061	<ul style="list-style-type: none"> <li>The built-in calibration sensor failed to open/close.</li> <li>Turn off the main power on the rear side of the monitor, wait for a few minutes before turning the power back on, and then execute SelfCalibration again.</li> </ul>

# Chapter 8 Reference

## 8-1. Attaching the Optional Arm

An optional arm (or an optional stand) can be attached by removing the stand section. Please refer to our web site for the corresponding optional arm (or optional stand). <http://www.eizoglobal.com>

### Attention

- When attaching an arm or stand, follow the instructions of their User's Manual.
- When using another manufacturer's arm or stand, confirm the following in advance and select one conforming to the VESA standard.
  - Clearance between screw holes: 100 mm × 100 mm
  - Plate thickness: 2.6 mm
  - Must be strong enough to support weight of the monitor unit (excluding the stand) and attachments such as cables.
- When using another manufacturer's arm or stand, use the following screws to secure it.
  - Screws fixing the stand to the monitor.
- When using an arm or stand, attach it to meet the following tilt angles of the monitor.
  - Up 45°, down 45°
- Connect the cables after attaching an arm or stand.
- Do not move the removed stand up and down. Doing so may result in injury or equipment damage.
- The monitor, arm, and stand are heavy. Dropping them may result in injury or equipment damage.
- When installing the monitor in portrait mode, turn the monitor screen 90° in clockwise direction.

### Attachment procedure

**1. To avoid damaging the panel surface, lay the monitor on a soft cloth spread on a stable surface with the panel surface facing down.**

**2. Remove the stand.**

Prepare a screwdriver. Using a screwdriver, remove the screws (four) securing the unit and the stand.

**3. Attach the arm or stand to the monitor.**

Secure the monitor to the arm or stand using the screws fixing the stand to the monitor.

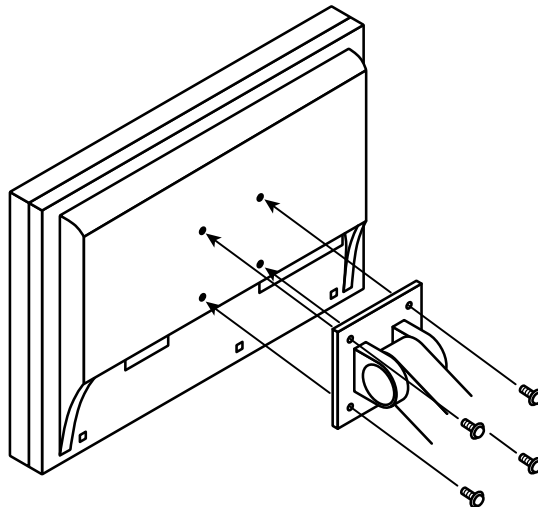

## 8-2. Making Use of USB (Universal Serial Bus)

This monitor has a USB hub. It works as a USB hub when connected to a USB-compatible PC, allowing the connection of peripheral USB devices.

### ● System Requirements

- A PC (including devices with a USB host function) and OS in conformance with USB Specification Revision 2.0
- USB cable

#### Attention

- This monitor may not work depending on the used PC, OS or peripheral devices. For USB compatibility of peripheral devices, contact their manufactures.
- When the monitor is in power saving mode, devices connected to the USB downstream port will still work. Therefore, power consumption of the monitor varies depending on the connected devices, even in the power saving mode.
- When the main power of the monitor is off, a device connected to the USB downstream port will not operate.

### ● How to connect

1. Connect the signal cable between a PC and the monitor, and turn on the PC.
2. Using the USB cable, connect the computer's USB downstream port and the monitor's USB upstream port 1.
3. Connect the peripheral USB device to the USB downstream port of the monitor.

#### Note

- By default, USB upstream port 1 is enabled. To connect two PCs, see [“5-4. Switching USB Port Automatically”](#) (page 43).

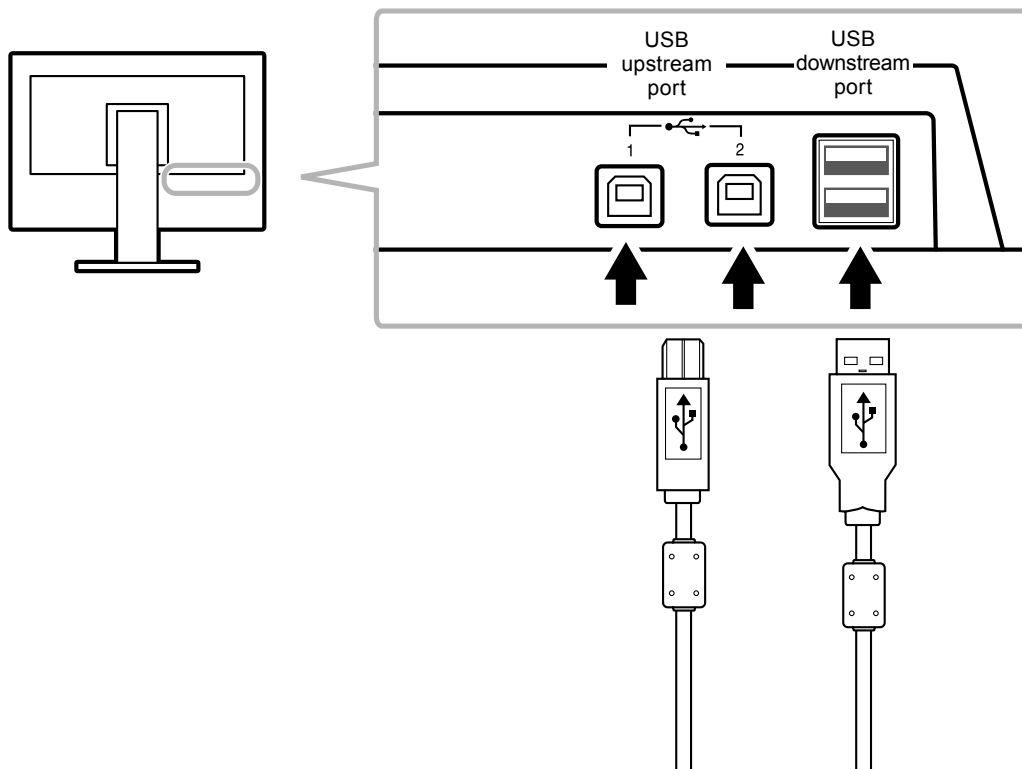

## 8-3. Showing Monitor Information

### ● Displaying signal information

This function displays the information about the current input signals displayed.

#### Procedure

1. Choose “Tools” from the Adjustment menu, and press ENTER.
2. Choose “Signal Info” from “Tools”, and press ENTER.

The “Signal Info” appears.

(Example)

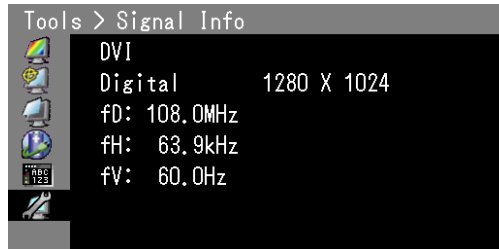

### ● Displaying Monitor Information

This function displays the information about the monitor.

#### Procedure

1. Choose “Tools” from the Adjustment menu, and press ENTER.
2. Choose “Monitor Info” from “Tools”, and press ENTER.

The “Monitor Info” appears.

This function displays the model name, serial number, firmware version, usage time, and ColorNavigator license status.

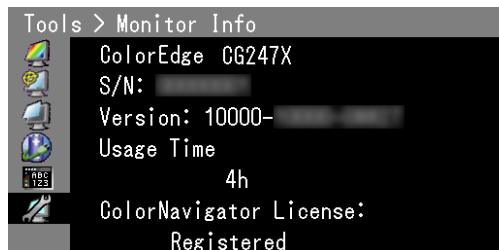

#### Attention

- Due to inspection at the factory, the usage time when the power to the monitor is first turned on may not be “0”.

## 8-4. Specifications

LCD Panel	Size		61.1 cm (24.1) format
	Type		Color TFT(IPS)
	Backlight		LED
	Display area (H × V)		518.4 mm × 324.0 mm
	Viewing angles		Horizontal: 178°, vertical: 178°
	Recommended Brightness		120 cd/m <sup>2</sup> or less (Temperature: 5000 K to 6500 K)
	Recommended resolution		1920 × 1200
	Contrast ratio		1500:1 (When “DUE Priority” setting is “Brightness”)
	Dot pitch		0.27 mm × 0.27 mm
	Response time	Black-white-black	Approx. 18 ms
		Gray-to-gray	Approx. 10 ms
Color gamut display (typical)	Adobe® RGB Coverage	99%	
	NTSC ratio	108%	
Video Signals	Input Terminals		DVI-D × 1 (Single Link , HDCP-compatible) HDMI × 1 (HDCP-compatible) DisplayPort × 1 (HDCP-compatible)
	Dot clock (Max.)		165 MHz
	Horizontal scanning frequency	DVI / DisplayPort / HDMI (PC)	26 kHz to 78 kHz
		HDMI (Video)	15 kHz to 78 kHz
	Vertical scan frequency	DVI / DisplayPort	23 Hz to 63 Hz (720 × 400: 69 Hz to 71 Hz)
		HDMI	24 Hz to 61 Hz (720 × 400: 69 Hz to 71 Hz)
		Frame Synchronization mode	23.75 Hz to 30.5 Hz 47.5 Hz to 61 Hz
	Max. display color	DisplayPort	Approx. 1073.74 million colors (for 10-bit input)
		HDMI	Approx. 1073.74 million colors (for 10-bit, 12-bit input)
		DVI	Approx. 16.77 million colors
	Plug & Play	DVI / HDMI	VESA DDC2B / EDID structure 1.3
DisplayPort		VESA DisplayPort / EDID structure 1.4	
Power			100–240 VAC ±10%, 50/60 Hz 0.65 A–0.35 A
	Power consumption	Screen display On	60 W or less
		Power saving mode	0.7 W or less (when only the DisplayPort is connected, “Input Selection” is set to “Manual”, and no USB device is connected)
		Power Off	0.5 W or less (when no USB device is connected, DP Power Save is set to “On”)
		Main power Off	0 W
	Power saving settings	DVI	DVI DMPM
DisplayPort		DisplayPort Standard V1.1a	

Physical Specifications	Dimensions (width) × (height) × (depth)	Main unit	575.0 mm × 417.0 mm–545.0 mm × 245.5 mm (When the Tilt is 0°)
		Main unit (without stand)	575.0 mm × 398.0 mm × 75.0 mm
		With monitor hood	596.0 mm × 427.8 mm–555.8 mm × 356.7 mm–380.0 mm (When the Tilt is 0°)
	Net. weight	Main unit	Approx. 8.9 kg
		Main unit (without stand)	Approx. 6.2 kg
		With monitor hood	Approx. 9.7 kg
	Movable range	Tilt	Up 30°, down 0°
		Swivel	344°
		Height adjustment	128.0 mm (When Tilt angle is 0°)
		Rotation:	90° (clockwise)
Environmental conditions	Temperature	Operating	0 °C to 35 °C (32 °F to 95 °F)
		Transportation/ Storage	-20 °C to 60 °C (-4 °F to 140 °F)
	Humidity (R.H, no condensation)	Operating	20% to 80%
		Transportation/ Storage	10% to 90%
	Air Pressure	Operating	540 hPa to 1060 hPa
		Transportation/ Storage	200 hPa to 1060 hPa
USB	Input Terminals		Upstream port × 2, Downstream port × 2
	Standard		USB Specification Revision 2.0
	Supply Current		Max. 500 mA / 1 port

## Main Default Settings

Color Mode		Custom
Screen Size	PC signal	Full
	video: HD signal (HDMI)	Enlarged
	video: SD signal (HDMI)	Auto
Color Space		Auto
Input Range	DVI	Full
	DisplayPort / HDMI	Auto
Noise Reduction		Off
Power Save		On
Language		English
Menu Position		Center
Input Selection		Manual
USB Selection		USB-1
Signal Format	DisplayPort	RGB
	HDMI	PC

# Outside Dimensions

Unit: mm

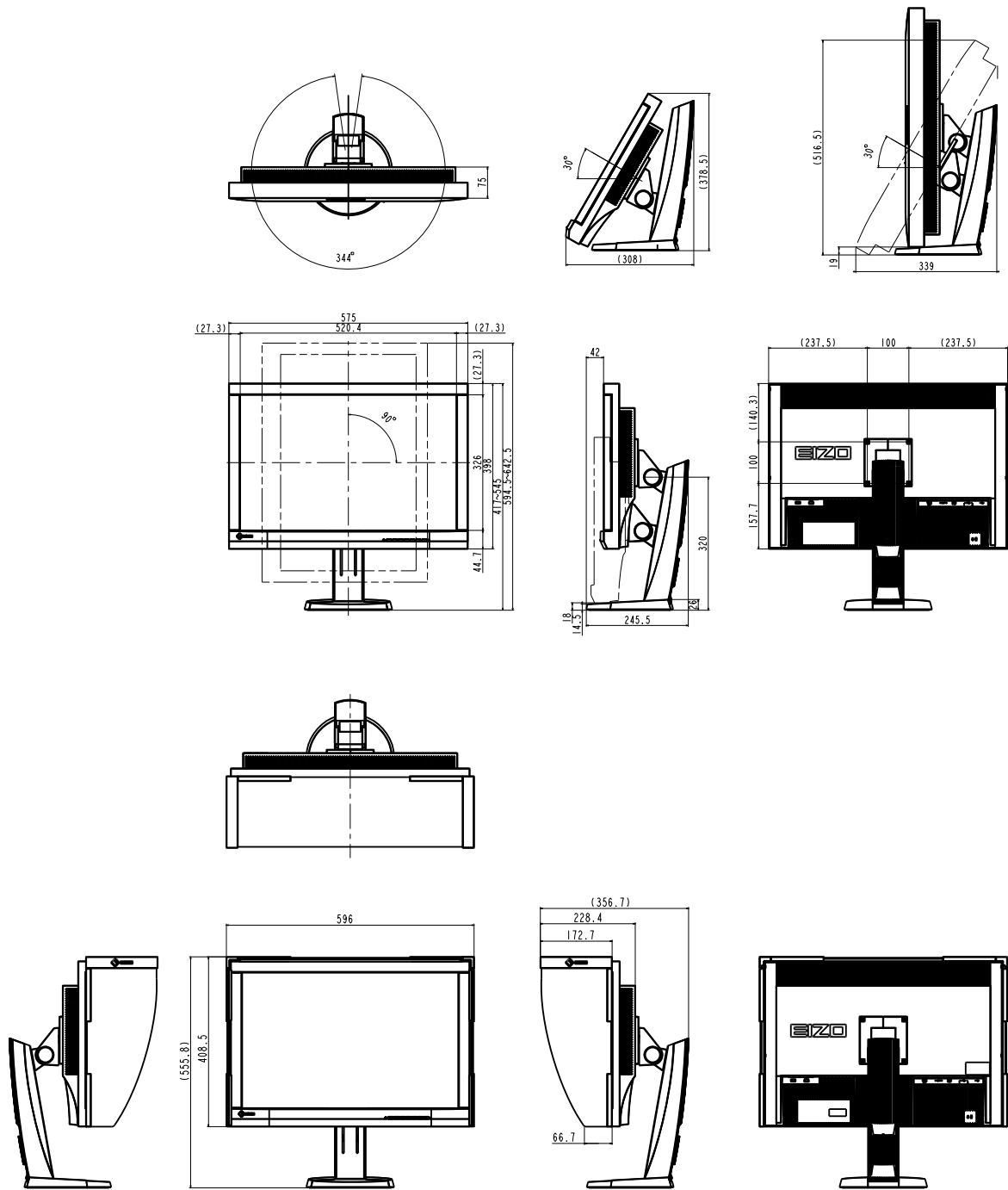

## Accessories

Signal cable	HH200HS (HDMI - HDMI) PP200 (DisplayPort - DisplayPort)
--------------	--

For the latest information about the accessories, refer to our web site.

<http://www.eizoglobal.com>

# Chapter 9 Glossary

## **Adobe®RGB**

This is a definition of the practical RGB color space proposed by Adobe Systems in 1998. The color reproduction range (color gamut) is broader than sRGB, and is highly adaptable to such fields as printing etc.

## **Color Space**

YUV and RGB, etc. are available. YUV expresses the color by using the luminance (Y), the color difference of Blue (U), and the color difference of Red (V).

RGB does this by using the gradation of the 3 colors, Red (R), Green (G), and Blue (B).

## **DCI (Digital Cinema Initiatives)**

The company was founded by an association of U.S. film studios, and this company decides the specifications for digital cinema.

## **DisplayPort**

This is the interface standard for image signals standardized in accordance with VESA. It was developed with the aim of replacing the conventional DVI and analog interfaces, and it can transmit high resolution signals and sound signals, which DVI does not support. The standard size and mini size connectors have been standardized.

## **DVI (Digital Visual Interface)**

DVI is a digital interface standard. DVI allows direct transmission of the PC's digital data without loss.

This adopts the TMDS transmission system and DVI connectors. There are two types of DVI connectors. One is a DVI-D connector for digital signal input only. The other is a DVI-I connector for both digital and analog signal inputs.

## **DVI DMPM (DVI Digital Monitor Power Management)**

DVI DMPM is a digital interface power saving function. The "Monitor ON (operating mode)" and "Active Off (power saving mode)" are indispensable for DVI DMPM as the monitor's power mode.

## **EBU (European Broadcasting Union)**

The organization also includes broadcasting offices from Europe and North Africa, and its role is to decide various technical standards etc.

## **Gain**

This is used to adjust each color parameter for red, green and blue. An LCD monitor displays the color by the light passing through the panel color filter. Red, green and blue are the three primary colors. All the colors on the screen are displayed by combining these three colors. The color tone can be changed by adjusting the light intensity (volume) passing through each color's filter.



## **Gamma**

Generally, the monitor brightness varies nonlinearly with the input signal level, which is called “Gamma Characteristic”. When the gamma value is low, the middle tone area is displayed brighter, and darker when high. Changes to the gamma value will not affect contrast. A gamma value appropriate for the display content should be selected.

## **HDCP (High-bandwidth Digital Content Protection)**

Digital signal coding system developed to copy-protect the digital contents, such as video, music, etc.

This helps to transmit the digital contents safely by coding the digital contents sent via the DVI or HDMI connector on the output side and decoding them on the input side.

Any digital contents cannot be reproduced if both of the equipments on the output and input sides are not applicable to HDCP system.

## **HDMI (High-Definition Multimedia Interface)**

HDMI is a digital interface standard, developed for consumer electrical appliance or AV device.

This standard is issued on the basis of the DVI standard which is one of an interface specification for the connection between a PC and a monitor. The projected image, sound and control signal without compressed enable to be transmitted with one cable.

## **L\***

L\* is a lightness value based on the CIELUV and CIELAB color spaces. CIELUV and CIELAB are color spaces that describe the relationship between color and human vision, in which L\* corresponds to perceived brightness.

## **Rec709**

Digital broadcasting (HDTV) standards defined by the ITU-R (International Telecommunication Union Radio Communication Sector).

## **Rec1886**

Standards for the input/output characteristics of flat panel displays used in studio production for digital broadcasting (HDTV) specified by the ITU-R based on CRT characteristics.

## **Resolution**

The LCD panel consists of numerous pixels of specified size, which are illuminated to form images. This monitor consists of horizontal 1920 pixels and 1200 vertical pixels. At a resolution of 1920 × 1200, all pixels are illuminated as a full screen (1:1).

## **SMPTE-C**

One of the standards provided by the SMPTE (Society of Motion Picture and Television Engineers).

## **sRGB (Standard RGB)**

International standard for color reproduction and color space among peripheral devices (such as monitors, printers, digital cameras, scanners). As a form of simple color matching for the Internet, colors can be displayed using tones close to those of the transmission and reception devices.

## Temperature

Color temperature is a method to measure the white color tone, generally indicated in degrees Kelvin. The screen becomes reddish at a low temperature, and bluish at a high temperature, like the flame temperature.

5000 K: Slightly reddish white

6500 K: White referred to as daylight-balanced color

9300 K: Slightly bluish white

# Appendix

## Trademark

The terms HDMI and HDMI High-Definition Multimedia Interface, and the HDMI Logo are trademarks or registered trademarks of HDMI Licensing, LLC in the United States and other countries.

The DisplayPort Compliance Logo and VESA are registered trademarks of the Video Electronics Standards Association.

Kensington and Microsaver are registered trademarks of ACCO Brands Corporation.

Intel, Intel Core, Pentium, and Thunderbolt are trademarks of Intel Corporation in the U.S. and/or other countries.

Microsoft, Windows and Windows Vista are registered trademarks of Microsoft Corporation in the United States and other countries.

Adobe is a registered trademark of Adobe Systems Incorporated in the United States and other countries.

Apple, Mac OS, Macintosh and ColorSync are registered trademarks of Apple Inc.

EIZO, the EIZO Logo, ColorEdge, DuraVision, FlexScan, FORIS, RadiCS, RadiForce, RadiNET, Raptor and ScreenManager are registered trademarks of EIZO Corporation in Japan and other countries.

ColorEdge Tablet Controller, ColorNavigator, CuratOR, EcoView NET, EIZO EasyPIX, EIZO Monitor Configurator, EIZO ScreenSlicer, G-Ignition, i•Sound, Re/Vue, Screen Administrator and UniColor are trademarks of EIZO Corporation.

All other company and product names are trademarks or registered trademarks of their respective owners.

## License / Copyright

A round gothic bold bit map font designed by Ricoh is used for the characters displayed on this product.

# FCC Declaration of Conformity

For U.S.A. , Canada, etc. (rated 100-120 Vac) Only

## FCC Declaration of Conformity

We, the Responsible Party

EIZO Inc.

5710 Warland Drive, Cypress, CA 90630

Phone: (562) 431-5011

declare that the product

Trade name: EIZO

Model: ColorEdge CG247X

is in conformity with Part 15 of the FCC Rules. Operation of this product is subject to the following two conditions: (1) this device may not cause harmful interference, and (2) this device must accept any interference received, including interference that may cause undesired operation.

This equipment has been tested and found to comply with the limits for a Class B digital device, pursuant to Part 15 of the FCC Rules. These limits are designed to provide reasonable protection against harmful interference in a residential installation. This equipment generates, uses, and can radiate radio frequency energy and, if not installed and used in accordance with the instructions, may cause harmful interference to radio communications. However, there is no guarantee that interference will not occur in a particular installation. If this equipment does cause harmful interference to radio or television reception, which can be determined by turning the equipment off and on, the user is encouraged to try to correct the interference by one or more of the following measures.

- \* Reorient or relocate the receiving antenna.
- \* Increase the separation between the equipment and receiver.
- \* Connect the equipment into an outlet on a circuit different from that to which the receiver is connected.
- \* Consult the dealer or an experienced radio/TV technician for help.

Changes or modifications not expressly approved by the party responsible for compliance could void the user's authority to operate the equipment.

### Note

Use the attached specified cable below or EIZO signal cable with this monitor so as to keep interference within the limits of a Class B digital device.

- AC Cord
- Shielded Signal Cable (enclosed)

## Canadian Notice

This Class B digital apparatus complies with Canadian ICES-003.

Cet appareil numérique de la classe B est conforme à la norme NMB-003 du Canada.

# LIMITED WARRANTY

## LIMITED WARRANTY

EIZO Corporation (hereinafter referred to as “**EIZO**”) and distributors authorized by EIZO (hereinafter referred to as the “**Distributors**”) warrant, subject to and in accordance with the terms of this limited warranty (hereinafter referred to as the “**Warranty**”), to the original purchaser (hereinafter referred to as the “**Original Purchaser**”) who purchased the product specified in this document (hereinafter referred to as the “**Product**”) from EIZO or Distributors, that EIZO and Distributors shall, at their sole discretion, either repair or replace the Product at no charge if the Original Purchaser becomes aware within the Warranty Period (defined below) that the Product malfunctions or is damaged in the course of normal use of the Product in accordance with the description in the instruction manual attached to the Product (hereinafter referred to as the “**User’s Manual**”).

The period of this Warranty is limited to (i) five (5) years from the date of purchase of the Product; or, limited to the expiration of (ii) 30,000 hours of its use of the Product (hereinafter referred to as the “**Warranty Period**”). However, the brightness of the Product shall be warranted only if the Product has been used within the recommended brightness described in the User’s Manual. The Warranty Period for the brightness is also limited to five (5) years from the date of purchase of the Product subject to the usage time being less than or equal to 10,000 hours. EIZO and Distributors shall bear no liability or obligation with regard to the Product in relation to the Original Purchaser or any third parties other than as provided under this Warranty.

EIZO and Distributors will cease to hold or store any parts (excluding design parts) of the Product upon the expiration of five (5) years after the production of such parts is discontinued. In repairing the monitor, EIZO and Distributors will use renewal parts which comply with our QC standards. If the unit cannot be repaired due to its condition or the stockout of a relevant part, EIZO and Distributors may offer the replacement by a product with equivalent performance instead of repairing it.

The Warranty is valid only in the countries or territories where the Distributors are located. The Warranty does not restrict any legal rights of the Original Purchaser.

Notwithstanding any other provision of this Warranty, EIZO and Distributors shall have no obligation under this Warranty whatsoever in any of the cases as set forth below:

- (a) Any defect of the Product caused by freight damage, modification, alteration, abuse, misuse, accident, incorrect installation, disaster, faulty maintenance and/or improper repair by third party other than EIZO and Distributors;
- (b) Any incompatibility of the Product due to possible technical innovations and/or regulations;
- (c) Any deterioration of the sensor;
- (d) Any deterioration of display performance caused by the deterioration of expendable parts such as the LCD panel and/or backlight, etc. (e.g. changes in brightness, changes in brightness uniformity, changes in color, changes in color uniformity, defects in pixels including burnt pixels, etc.);
- (e) Any deterioration of the Product caused by the use at higher brightness than the recommended brightness described in the User’s Manual;
- (f) Any defect of the Product caused by external equipment;
- (g) Any defect of the Product on which the original serial number has been altered or removed;
- (h) Any normal deterioration of the product, particularly that of consumables, accessories, and/or attachments (e.g. buttons, rotating parts, cables, User’s Manual, etc.); and
- (i) Any deformation, discoloration, and/or warp of the exterior of the product including that of the surface of the LCD panel.

To obtain service under the Warranty, the Original Purchaser must deliver the Product, freight prepaid, in its original package or other adequate package affording an equal degree of protection, assuming the risk of damage and/or loss in transit, to the local Distributor. The Original Purchaser must present proof of purchase of the Product and the date of such purchase when requesting services under the Warranty.

The Warranty Period for any replaced and/or repaired product under this Warranty shall expire at the end of the original Warranty Period.

EIZO OR DISTRIBUTORS ARE NOT RESPONSIBLE FOR ANY DAMAGE TO, OR LOSS OF, DATA OR OTHER INFORMATION STORED IN ANY MEDIA OR ANY PART OF ANY PRODUCT RETURNED TO EIZO OR DISTRIBUTORS FOR REPAIR.

EIZO AND DISTRIBUTORS MAKE NO FURTHER WARRANTIES, EXPRESSED OR IMPLIED, WITH RESPECT TO THE PRODUCT AND ITS QUALITY, PERFORMANCE, MERCHANTABILITY OR FITNESS FOR ANY PARTICULAR USE. IN NO EVENT SHALL EIZO OR DISTRIBUTORS BE LIABLE FOR ANY INCIDENTAL, INDIRECT, SPECIAL, CONSEQUENTIAL OR OTHER DAMAGE WHATSOEVER (INCLUDING, WITHOUT LIMITATION, DAMAGES FOR LOSS OF PROFIT, BUSINESS INTERRUPTION, LOSS OF BUSINESS INFORMATION, OR ANY OTHER PECUNIARY LOSS) ARISING OUT OF THE USE OR INABILITY TO USE THE PRODUCT OR IN ANY CONNECTION WITH THE PRODUCT, WHETHER BASED ON CONTRACT, TORT, NEGLIGENCE, STRICT LIABILITY OR OTHERWISE, EVEN IF EIZO OR DISTRIBUTORS HAVE BEEN ADVISED OF THE POSSIBILITY OF SUCH DAMAGES. THIS EXCLUSION ALSO INCLUDES ANY LIABILITY WHICH MAY ARISE OUT OF THIRD PARTY CLAIMS AGAINST THE ORIGINAL PURCHASER. THE ESSENCE OF THIS PROVISION IS TO LIMIT THE POTENTIAL LIABILITY OF EIZO AND DISTRIBUTORS ARISING OUT OF THIS LIMITED WARRANTY AND/OR SALES.

# Recycling Information

---

## Recycling Information

This product, when disposed of, is supposed to be collected and recycled according to your country's legislation to reduce environmental burden. When you dispose of this product, please contact a distributor or an affiliate in your country.

The contact addressees are listed on the EIZO website below.

<http://www.eizoglobal.com>

For recycling information for customers in Switzerland, please refer to the following website.

<http://www.swico.ch>

## Informationen zum Thema Recycling

Dieses Produkt muss gemäß den Vorschriften Ihres Landes zur Entlastung der Umwelt recyclet werden. Wenden Sie sich bei der Entsorgung dieses Produkts an einen Verteiler oder eine Tochtergesellschaft in Ihrem Land.

Die Adressen zur Kontaktaufnahme sind auf der unten angegebenen Website von EIZO aufgeführt.

<http://www.eizoglobal.com>

Kunden in der Schweiz entnehmen Informationen zum Recycling der folgenden Website:

<http://www.swico.ch>

## Informations sur le recyclage

Ce produit doit être jeté aux points de collecte prévus à cet effet et recyclé conformément à la législation de votre pays, afin de réduire l'impact sur l'environnement. Lorsque vous jetez ce produit, veuillez contacter un distributeur ou une société affiliée de votre pays.

Les adresses des distributeurs sont répertoriées sur le site Web EIZO ci-dessous.

<http://www.eizoglobal.com>

Pour les clients en Suisse, veuillez consulter le site Web suivant afin d'obtenir des informations sur le recyclage.

<http://www.swico.ch>

## Información sobre reciclaje

Este producto debe desecharse y reciclarse según la legislación del país para reducir el impacto medioambiental. Cuando desee deshacerse de este producto, póngase en contacto con un distribuidor o una filial de su país.

Encontrará las direcciones de contacto en el sitio web de EIZO que se indica a continuación.

<http://www.eizoglobal.com>

## Informazioni sul riciclaggio

Per lo smaltimento e il riciclaggio del presente prodotto, attenersi alle normative vigenti nel proprio paese per ridurre l'impatto ambientale. Per lo smaltimento, rivolgersi ad un distributore o un affiliato presenti nel proprio paese.

Gli indirizzi sono elencati nel sito Web EIZO riportato di seguito.

<http://www.eizoglobal.com>

Per informazioni sul riciclaggio per i clienti in Svizzera, consultare il sito Web riportato di seguito.

<http://www.swico.ch>

## Återvinningsinformation

När denna produkt kasseras ska den hanteras och återvinnas enligt landets föreskrifter för att reducera miljöpåverkan. När du kasserar produkten ska du kontakta en distributör eller representant i ditt land.

Kontaktadresserna listas på EIZO-webbplatsen nedan.

<http://www.eizoglobal.com>

## Πληροφορίες ανακύκλωσης

Το προϊόν αυτό, όταν απορρίπτεται, πρέπει να συλλέγεται και να ανακυκλώνεται σύμφωνα με τη νομοθεσία της χώρας σας έτσι ώστε να μην επιβαρύνει το περιβάλλον. Για να απορρίψετε το προϊόν, επικοινωνήστε με έναν αντιπρόσωπο ή μια θυγατρική εταιρεία στη χώρα σας.

Οι διευθύνσεις επικοινωνίας αναγράφονται στην τοποθεσία web της EIZO παρακάτω.  
<http://www.eizoglobal.com>

## Сведения по утилизации

По истечении срока службы данного продукта его следует принести на сборный пункт и утилизировать в соответствии с действующими предписаниями в вашей стране, чтобы уменьшить вредное воздействие на окружающую среду. Прежде чем выбросить данный продукт, обратитесь к дистрибьютору или в местное представительство компании в вашей стране.

Контактные адреса можно найти на веб-узле EIZO.

<http://www.eizoglobal.com>

## Informatie over recycling

Wanneer u dit product wilt weggooien, moet het uit milieu-overwegingen worden verzameld en gerecycled volgens de betreffende wetgeving van uw land. Wanneer u dit product wilt weggooien, moet u contact opnemen met een distributeur of een partner in uw land.

De contactadressen worden vermeld op de volgende EIZO-website.

<http://www.eizoglobal.com>

## Informação sobre reciclagem

Este produto, quando o deitar fora, deve ser recolhido e reciclado de acordo com a legislação do seu país para reduzir a poluição. Quando deitar fora este produto, contacte um distribuidor ou uma filial no seu país.

Os endereços de contacto estão listados no website do EIZO, abaixo.

<http://www.eizoglobal.com>

## Oplysninger om genbrug

Dette produkt forventes ved bortskaffelse at blive indsamlet og genbrugt i overensstemmelse med lovgivningen i dit land for at reducere belastningen af miljøet. Når du bortskaffer denne produkt, skal du kontakte en distributør eller et tilknyttet selskab i dit land.

Adresserne på kontaktpersonerne er angivet på EIZO's websted nedenfor.

<http://www.eizoglobal.com>

## Kierrätystä koskevia tietoja

Tuote tulee hävittää kierrättämällä maan lainsäädännön mukaisesti ympäristön kuormittumisen vähentämiseksi. Kun hävität tuotteen, ota yhteyttä jälleenmyyjään tai tytäryhtiöön maassasi.

Yhteystiedot löytyvät EIZOn Internet-sivustolta.

<http://www.eizoglobal.com>

## Wykorzystanie surowców wtórnych

Ten produkt po zużyciu powinien być zbierany i przetwarzany zgodnie z krajowymi przepisami dotyczącymi ochrony środowiska. Wyrzucając ten produkt, należy skontaktować się z lokalnym dystrybutorem lub partnerem. Adresy kontaktowe można znaleźć we wskazanej poniżej witrynie internetowej firmy EIZO.

<http://www.eizoglobal.com>

## Informace o recyklaci

Při likvidaci produktu musí být produkt vyzvednut a recyklován podle zákonů příslušné země, aby nedocházelo k zatěžování životního prostředí. Zbavujete-li se produktu, kontaktujte distributora nebo pobočku ve své zemi. Kontaktní adresy jsou uvedeny na následující webové stránce společnosti EIZO.  
<http://www.eizoglobal.com>

## Ringlussevõtu alane teave

Keskkonnakoormuse vähendamiseks tuleks kasutatud tooted kokku koguda ja võtta ringlusse vastavalt teie riigi seadustele. Kui kõrvaldate käesoleva toote, võtke palun ühendust turustaja või filiaaliga oma riigis. Kontaktisikud on toodud EIZO veebilehel järgmisel aadressil:  
<http://www.eizoglobal.com>

## Újrahasznosítási információ

Jelen terméket, amikor eldobjuk, az illető ország törvényei alapján kell összegyűjteni és újrahasznosítani, hogy csökkentsük a környezet terhelését. Amikor ezt a terméket eldobja, kérjük lépjen kapcsolatba egy országon belüli forgalmazóval vagy társvállalkozással.  
A kapcsolat címei az EIZO alábbi weboldalán találhatók felsorolva:  
<http://www.eizoglobal.com>

## Podatki o recikliranju

Ob koncu uporabe odslužen izdelek izročite na zbirno mesto za recikliranje v skladu z okoljevarstveno zakonodajo vaše države. Prosimo, da se pri odstranjevanju izdelka obrnete na lokalnega distributerja ali podružnico.  
Kontaktne naslovi so objavljeni na spodaj navedenih spletnih straneh EIZO:  
<http://www.eizoglobal.com>

## Informácie o recyklácii

Pri likvidácii musí byť tento výrobok recyklovaný v súlade s legislatívou vašej krajiny, aby sa znížilo zaťaženie životného prostredia. Keď sa chcete zbaviť tohto výrobku, kontaktujte prosím distribútora alebo pobočku vo vašej krajine.  
Zoznam kontaktných adries je uvedený na nasledovnej webovej stránke firmy EIZO:  
<http://www.eizoglobal.com>

## Pārstrādes informācija

Utilizējot šo produktu, tā savākšana un pārstrāde veicama atbilstoši jūsu valsts likumdošanas prasībām attiecībā uz slodzes uz vidi samazināšanu. Lai veiktu šī produkta utilizāciju, sazinieties ar izplatītāju vai pārstāvniecību jūsu valstī.  
Kontaktadrese ir norādītas zemāk minētajā EIZO tīmekļa vietnē.  
<http://www.eizoglobal.com>

## Informacja apie gražinamąjį perdirbimą

Šalinant (išmetant) šiuos gaminius juos reikia surinkti ir perdirbti gražinamuoju būdu pagal jūsų šalies teisės aktus, siekiant sumažinti aplinkos teršimą. Kai reikia išmesti šį gaminį, kreipkitės į jūsų šalyje veikiančią gaminių pardavimo atstovybę arba jos filiaalą.  
Kontaktiniai adresatai nurodyti EIZO interneto svetainėje.  
<http://www.eizoglobal.com>



## Информация относно рециклиране

При изхвърлянето на този продукт се предлага събирането и рециклирането му съобразно законите на вашата страна за да се намали замърсяването на околната среда. Когато искате да се освободите от този продукт, моля свържете се с търговския му представител или със съответните органи отговарящи за това във вашата страна.

Данните за връзка с нас са описани на следния Интернет сайт на EIZO:  
<http://www.eizoglobal.com>

## Informație referitoare la reciclare

Acest produs, când debarasat, trebuie colectat și reciclat conform legislației țării respective ca să reducem sarcina mediului. Când se debarasează de acest produs, vă rugăm să contactați un distribuitor sau un afiliat al țării respective.

Adresele de contact le găsiți pe pagina de web al EIZO:  
<http://www.eizoglobal.com>

## معلومات عن إعادة التدوير

عند التخلص من هذا المنتج، من الضروري تجميعه وإعادة تدويره وفقاً للقوانين المتبعة في بلدك لتقليل العبء المسلط على البيئة. عندما تتخلص من هذا المنتج، يرجى الاتصال بموزع أو طرف متنسب إليه في بلدك. عناوين الاتصال مدرجة في موقع ايزو EIZO ادناه على شبكة الانترنت.

<http://www.eizoglobal.com>

## Geri Dönüşüm Bilgisi

Bu ürünün, atılacağı zaman, ülkenizin çevre kirliliğinin azaltılması konusundaki mevzuatına göre toplanması ve yeniden değerlendirilmesi gerekmektedir. Ürünü atacağınız zaman lütfen ülkenizdeki bir distribütör veya ilgili kuruluşla temasa geçiniz.

İrtibat adresleri aşağıdaki EIZO web sitesinde verilmiştir.  
<http://www.eizoglobal.com>

