

# User's Manual

# ColorEdge®

# CG241W

## Calibration Color LCD Monitor

### Important

Please read PRECAUTIONS, this User's Manual and Setup Manual (separate volume) carefully to familiarize yourself with safe and effective usage.





The latest User's Manual is available for download from our site:  
<http://www.eizo.com>

SAFETY SYMBOLS .....	2
⚠ PRECAUTIONS.....	3
1. Introduction .....	7
1-1. Features .....	7
1-2. Buttons and Indicators .....	8
1-3. Utility Disk .....	9
2. Installation.....	10
2-1. Connecting Two PCs to the Monitor .....	10
2-2. Making Use of USB (Universal Serial Bus).....	12
3. Screen Adjustment and Settings .....	13
3-1. Basic Operation and Functions .....	13
3-2. Screen Adjustment.....	15
3-3. Color Adjustment.....	18
3-4. Power-save Setup .....	21
3-5. Off Timer .....	22
3-6. Locking the settings.....	22
3-7. Power Indicator Setting .....	23
3-8. Automatic brightness adjustment .....	23
3-9. Displaying Lower Resolutions .....	24
3-10. Setting the orientation of the Adjustment menu.....	25
3-11. EIZO Logo Appearing Function.....	25
4. Troubleshooting .....	26
5. Reference .....	29
5-1. Attaching an arm .....	29
5-2. Environmental Settings (Digital signals only).....	30
5-3. Cleaning .....	31
5-4. Specifications .....	32
5-5. Glossary .....	35
6. APPENDIX/ANHANG/ANNEXE .....	37
About TCO'03 .....	39
FCC Declaration of Conformity.....	40
Hinweise zur Auswahl des richtigen Schwenkarms für Ihren Monitor / Hinweis zur Ergonomie.....	41
<b>How to Setup</b> Please read the Setup Manual (separate volume)	



## SAFETY SYMBOLS

This manual uses the safety symbols below. They denote critical information. Please read them carefully.

	<p><b>WARNING</b> Failure to abide by the information in a WARNING may result in serious injury and can be life threatening.</p>
	<p><b>CAUTION</b> Failure to abide by the information in a CAUTION may result in moderate injury and/or property or product damage.</p>
	<p>Indicates a prohibited action.</p>
	<p>Indicates to ground for safety.</p>

Copyright© 2007-2013 EIZO Corporation All rights reserved. No part of this manual may be reproduced, stored in a retrieval system, or transmitted, in any form or by any means, electronic, mechanical, or otherwise, without the prior written permission of EIZO Corporation.

EIZO Corporation is under no obligation to hold any submitted material or information confidential unless prior arrangements are made pursuant to EIZO Corporation's receipt of said information. Although every effort has been made to ensure that this manual provides up-to-date information, please note that EIZO monitor specifications are subject to change without notice.

ENERGY STAR is a registered trademark of the United States Environmental Protection Agency in the United States and other countries.

Apple, Macintosh, Power Macintosh and Power Mac are registered trademarks of Apple Inc.

VESA is a registered trademark or a trademark of Video Electronics Standards Association in the United States and other countries.

Windows and Windows Vista are registered trademarks of Microsoft Corporation in the United States and/or other countries.

ColorNavigator and UniColor Pro are trademarks of EIZO Corporation.

EIZO, EIZO Logo, ColorEdge and ScreenManager are registered trademarks of EIZO Corporation in Japan and other countries.

	<p>As an ENERGY STAR® Partner, EIZO Corporation has determined that this product meets the ENERGY STAR guidelines for energy efficiency.</p>
---	--

<p>Product specifications may vary depending on the region. Confirm the specifications in the manual written in the language of the region of purchase.</p>
---

# PRECAUTIONS

## IMPORTANT!

- This product has been adjusted specifically for use in the region to which it was originally shipped. If operated outside the region to which it was originally shipped, the product may not perform as stated in the specifications.
- To ensure personal safety and proper maintenance, please read this section and the caution statements on the unit (refer to the figure below).

### [Location of the Caution Statements]

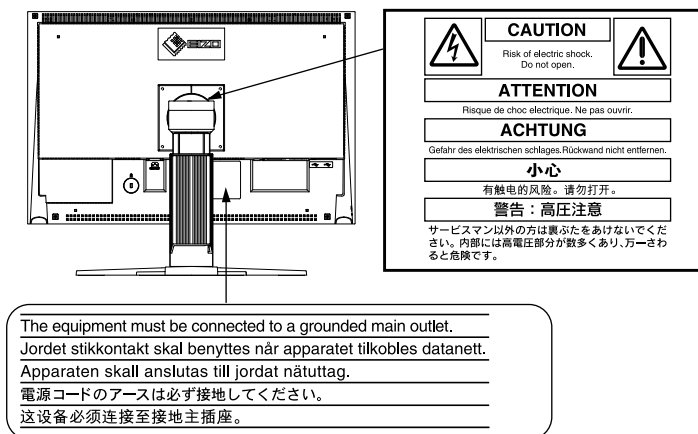

## WARNING

**If the unit begins to emit smoke, smells like something is burning, or makes strange noises, disconnect all power connections immediately and contact your dealer for advice.**

Attempting to use a malfunctioning unit may result in fire, electric shock, or equipment damage.

**Do not open the cabinet or modify the unit.**

Opening the cabinet or modifying the unit may result in fire, electric shock, or burn.



**Refer all servicing to qualified service personnel.**

Do not attempt to service this product yourself as opening or removing covers may result in fire, electric shock, or equipment damage.

**Keep small objects or liquids away from the unit.**

Small objects accidentally falling through the ventilation slots into the cabinet or spillage into the cabinet may result in fire, electric shock, or equipment damage. If an object or liquid falls/spills into the cabinet, unplug the unit immediately. Have the unit checked by a qualified service engineer before using it again.

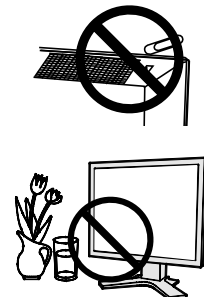

---

**⚠ WARNING**

---

**Place the unit at the strong and stable place.**

A unit placed on an inadequate surface may fall and result in injury or equipment damage.  
If the unit falls, disconnect the power immediately and ask your dealer for advice.  
Do not continue using a damaged unit. Using a damaged unit may result in fire or electric shock.

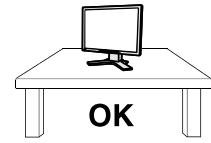

---

**Set the unit in an appropriate location.**

Not doing so may result in fire, electric shock, or equipment damage.

- Do not place outdoors.
- Do not place in the transportation system (ship, aircraft, trains, automobiles, etc.)
- Do not place in a dusty or humid environment.
- Do not place in a location where the steam comes directly on the screen.
- Do not place near heat generating devices or a humidifier.

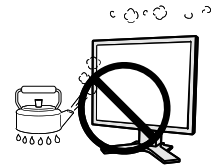

---

**To avoid danger of suffocation, keep the plastic packing bags away from babies and children.**

---

**Use the enclosed power cord and connect to the standard power outlet of your country.**

Be sure to remain within the rated voltage of the power cord. Not doing so may result in fire or electric shock.

Power supply: 100-120/200-240 Vac, 50/60 Hz

---

**To disconnect the power cord, grasp the plug firmly and pull.**

Tugging on the cord may damage and result in fire or electric shock.

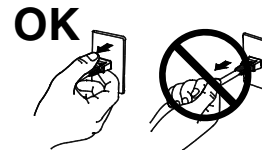

---

**The equipment must be connected to a grounded main outlet.**

Not doing so may cause in fire or electric shock.



---

**Use the correct voltage.**

- The unit is designed for use with a specific voltage only. Connection to another voltage than specified in this User's Manual may cause fire, electric shock, or equipment damage.

Power supply: 100-120/200-240 Vac, 50/60 Hz

- Do not overload your power circuit, as this may result in fire or electric shock.

---

**Handle the power cord with care.**

- Do not place the cord underneath the unit or other heavy objects.
- Do not pull on or tie the cord.

If the power cord becomes damaged, stop using it. Use of a damaged cord may result in fire or electric shock.



---

**Never touch the plug and power cord if it begins to thunder.**

Touching them may result in electric shock.



## WARNING

**When attaching an arm stand, please refer to the user's manual of the arm stand and install the unit securely.**

Not doing so may cause the unit to come unattached, which may result in injury or equipment damage. When the unit is dropped, please ask your dealer for advice. Do not continue using a damaged unit. Using a damaged unit may result in fire or electric shock. When reattaching the tilt stand, please use the same screws and tighten them securely.

**Do not touch a damaged LCD panel directly with bare hands.**

The liquid crystal which leaks from the panel is poisonous if it enters the eyes or mouth.

If any part of the skin or body comes in direct contact with the panel, please wash thoroughly. If some physical symptoms result, please consult your doctor.



**Lamps contain mercury, dispose according to local, state or federal laws.**

## CAUTION

**Handle with care when carrying the unit.**

Disconnect the power cord and cables when moving the unit. Moving the unit with the cord attached is dangerous. It may result in injury.

**When handling the unit, grip the bottom of the unit firmly with both hands ensuring the panel faces outward before lifting.**

Dropping the unit may result in injury or equipment damage.

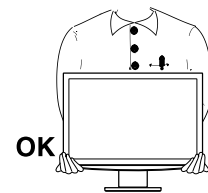

**Do not block the ventilation slots on the cabinet.**

- Do not place any objects on the ventilation slots.
- Do not install the unit in a closed space.
- Do not use the unit laid down or upside down.

Blocking the ventilation slots prevents proper airflow and may result in fire, electric shock, or equipment damage.



**Do not touch the plug with wet hands.**

Doing so may result in electrical shock.



**Use an easily accessible power outlet.**

This will ensure that you can disconnect the power quickly in case of a problem.

**Periodically clean the area around the plug.**

Dust, water, or oil on the plug may result in fire.

**Unplug the unit before cleaning it.**

Cleaning the unit while it is plugged into a power outlet may result in electric shock.

**If you plan to leave the unit unused for an extended period, disconnect the power cord from the wall socket after turning off the power switch for the safety and the power conservation.**

## **Notice for this monitor**

---

---

In order to suppress the luminosity change by long-term use and to maintain the stable luminosity, use of a monitor in lower brightness is recommended.

---

The LCD panel is manufactured using high-precision technology. However, note that the appearance of any missing pixels or lit pixels does not indicate damage to the LCD monitor.  
Percentage of effective pixels : 99.9994% or higher.

---

The backlight of the LCD panel has a fixed life span. When the screen becomes dark or begins to flicker, please contact your dealer.

---

Do not press on the panel or edge of the frame strongly, as this may result in damage to the screen. There will be prints left on the screen if the pressed image is dark or black. If pressure is repeatedly applied to the screen, it may deteriorate or damage your LCD panel. Leave the screen white or black to decrease the prints.

---

When the screen image is changed after displaying the same image for extended periods of time, an afterimage may appear. Use the screen saver or timer to avoid displaying the same image for extended periods of time.

---

When the monitor is cold and brought into a room or the room temperature goes up quickly, dew condensation may occur inside and outside the monitor. In that case, do not turn the monitor on and wait until dew condensation disappears, otherwise it may cause some damages to it.

---

Do not scratch or press on the panel with any sharp objects, such as a pencil or pen as this may result in damage to the panel. Do not attempt to brush with tissues as this may scratch the LCD panel.

---

---

## **To use the monitor comfortably**

---

---

An excessively dark or bright screen may affect your eyes. Adjust the brightness of the monitor according to the environmental conditions.

---

Staring at the monitor for a long time tires your eyes. Take a 10-minute rest every hour.

---

---

---

# 1. Introduction

Thank you very much for choosing an EIZO Color Monitor.

## 1-1. Features

---

- 24" wide format LCD
- Wide color gamut of 96% of Adobe RGB
- Applicable to HDCP
- Dual inputs compliant (DVI-I x 2)
- DVI Digital input (TMDS ) compliant
- [Horizontal scanning frequency]  
Analog: 24 - 94kHz  
Digital: 26 - 78 kHz
- [Vertical scanning frequency]  
Analog: 47.5 - 86Hz (1600x1200: 47.5 - 76Hz / 1920x1200: 47.5 - 61Hz)  
Digital: 47.5 - 63Hz (VGA text: 69 - 71Hz)
- [Resolution] 1920 dots x 1200 lines
- Frame Synchronous mode supported (47.5 - 63Hz)
- The Portrait/Landscape display capability (rotate 90 degrees clockwise)
- The provided Color Management Software "ColorNavigator" enables you to calibrate monitor characteristics and generate ICC profiles (for Windows) and Apple ColorSync profiles (for Macintosh) (refer to the EIZO LCD Utility Disk)
- Color Vision Deficiency Simulation Software "UniColor Pro" supported  
(This software can be downloaded from <http://www.eizo.com>)
- Smoothing function incorporated for the adjustment of an enlarged image
- FineContrast modes, to select the most suitable mode for screen display
- Height adjustable stand
- BrightRegulator function incorporate
- Attaching the "Adjustment Certificate" to describe the grayscale and uniformity characteristics of the monitor individually
- Monitor hood attached

---

### Tips

- This monitor supports the Portrait/Landscape display. This function allows you to change the orientation of the Adjustment menu when using the monitor screen in vertical display position. (Refer to "3-10. Setting the orientation of the Adjustment menu" on page 25.)
  - If you use the monitor with "Portrait" position, the setting may be required to change depending on the graphics board used in your PC. Refer to the manual of the graphics board for details.
-

## 1-2. Buttons and Indicators

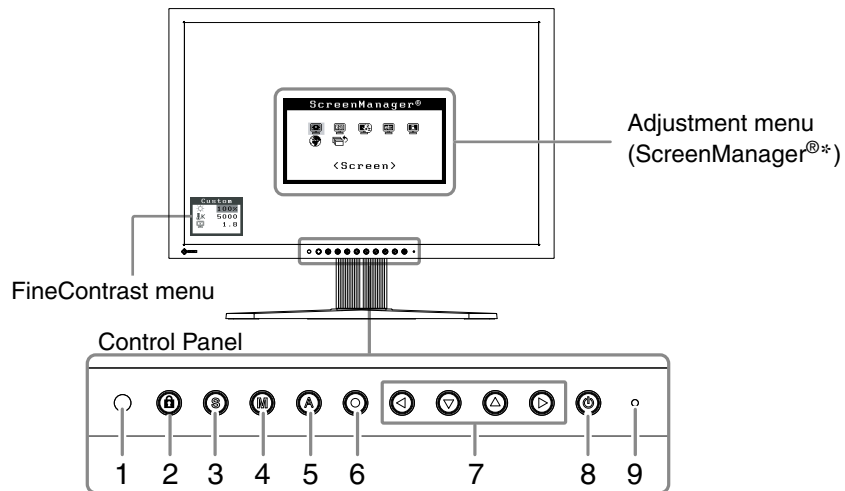

1. Sensor (BrightRegulator)
2. Adjustment Lock button
3. Input Signal Selection button
4. Mode button
5. Auto Adjustment button
6. Enter button
7. Control buttons (Left, Down, Up, Right)
8. Power button
9. Power indicator

Indicator status	Operation status
Blue	The screen is displayed
Flashing blue (2 times for each)	When the timer is set for ColorNavigator, notifies that a recalibration is required (for CAL mode or EMU mode)
Orange	Power saving
Off	Power off

\*ScreenManager® is an EIZO's nickname of the Adjustment menu.



## 1-3. Utility Disk

An "EIZO LCD Utility Disk" (CD-ROM) is supplied with the monitor. The following table shows the disk contents and the overview of the software programs.

### Disk contents and software overview

The disk includes software programs for adjustment, and User's Manual. Refer to "Readme.txt" or the "read me" file on the disk for software startup procedures or file access procedures.

Item	Overview	For Windows	For Macintosh
A "Readme.txt" or "read me" file		√	√
ColorNavigator	An application software for calibrating monitor characteristics and generating ICC profiles (for Windows) and Apple ColorSync profiles (for Macintosh). (A PC must be connected to the monitor with the supplied USB cable.) Refer to the description later.	√	√
Screen adjustment pattern files	Used when adjusting the image of the analog signal input manually.	√	—
User's Manual (PDF file)		√	√

### To use ColorNavigator

Refer to the corresponding User's Manual on the CD-ROM disk in order to install and use the software. When using this software, you will need to connect a PC to the monitor with the supplied USB cable. For more information refer to the "2-2. Making Use of USB (Universal Serial Bus)" (page 12).

# 2. Installation

## 2-1. Connecting Two PCs to the Monitor

Two PCs can be connected to the monitor through the DVI-I connector on the back of the monitor.

### Connection examples

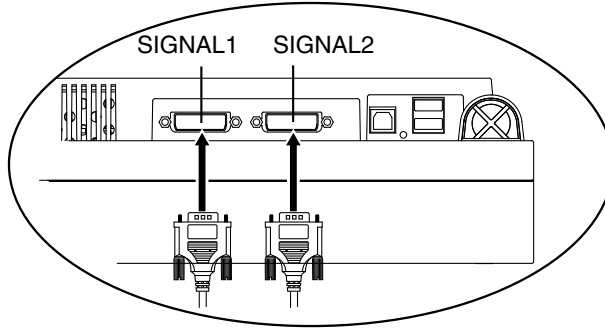

PC 1			PC 2			
(Ex.1)	Digital	DVI	Signal Cable (FD-C39 enclosed)	Signal Cable (FD-C16 enclosed)	D-Sub mini 15 pin	Analog
(Ex.2)	Analog	D-Sub mini 15 pin	Signal Cable (FD-C16 enclosed)	Signal Cable (FD-C16 optional)	D-Sub mini 15 pin	Analog

### Selecting input signal

Switch the input signal with . Input signal switches each time is pressed. When the signal is switched, the active signal type (Signal 1 or 2/ Analog or Digital) appears at the top right corner of the screen for two seconds.

Input Signal Selection button



This function is used to select which PC will have priority to control the monitor when utilizing two PCs. The monitor constantly checks the input signals and switches automatically in accordance with the <Input Priority> setting (see table below). Once a priority is set, whenever a change of signal is detected at the selected input, the monitor will switch the input to that signal.

In this case of only one signal being present at either input, the monitor automatically detects and displays that signal.

---

Priority setting	Performance
1	If signals from both inputs are present, the monitor gives preference to Signal 1 in the following cases. <ul style="list-style-type: none"><li>• When the power of the monitor is turned ON.</li><li>• When the signal input to Signal 1 is changed even if active input was Signal 2.</li></ul>
2	If signals from both inputs are present, the monitor gives preference to Signal 2 in the following cases. <ul style="list-style-type: none"><li>• When the power of the monitor is turned ON.</li><li>• When the signal input to Signal 2 is changed even if active input was Signal 1.</li></ul>
Manual	The monitor will not detect signals automatically in this mode. Select the active input by pressing  .

**NOTE**

- When the "1" or "2" is selected, the power saving mode of the monitor activates only if both PCs are in power saving mode.
-

---

## 2-2. Making Use of USB (Universal Serial Bus)

---

This monitor provides a hub which supports the USB standard. When connecting to a USB compliant PC or another hub, the monitor functions as a hub to which the USB compliant peripherals can be easily connected.

### Required system environment

- PC equipped with USB ports or another USB hub connected to the USB compliant PC
- Windows 8 / Windows 7 / Windows Vista / Windows XP / Windows 2000 or Mac OS X 10.2 or later and Mac OS 9.2.2
- USB Cable (MD-C93, enclosed)

---

#### **NOTE**

- The USB hub function may not work properly depending on the PC or peripherals. Please consult the manufacturer of each device about the USB support.
  - Using the USB Rev. 2.0 compatible PC or peripherals is recommended.
  - If the monitor is in the power saving mode, or if the monitor is connected to the power outlet with the monitor turned off, all the devices connected to the USB ports (upstream and downstream) work. Therefore, power consumption of the monitor varies with connected devices even in the power saving mode.
  - The followings are procedures for the Windows 8 / Windows 7 / Windows Vista / Windows XP / Windows 2000 and Mac OS.
- 

### Connecting to the USB HUB

- 1** Connect the monitor to the PC with the signal cable first, then turn on the PC.
- 2** Connect the upstream port of the monitor to the downstream port of the USB compliant PC or another hub by using the USB cable.  
After connecting the USB cable, the USB function can be set up automatically.
- 3** After setting up, the monitor's USB hub is available for connecting USB compliant peripherals to the downstream ports of the monitor.

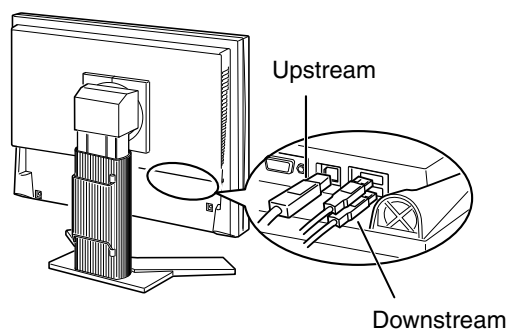

# 3. Screen Adjustment and Settings

## 3-1. Basic Operation and Functions

Adjustment menu allows you to adjust screen performance through the main menu and select a FineContrast mode easily.

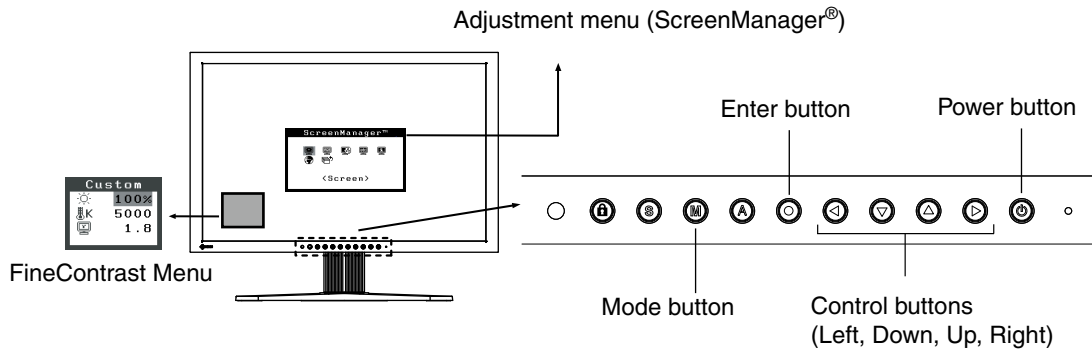

### NOTE

- The Adjustment menu and the FineContrast menu cannot be displayed at the same time.

### 1 Entering the Adjustment menu

Press **C** once to display the main menu of the Adjustment menu.

### 2 Making Adjustments and Settings

1. Select the desired sub menu icon using **←↓↑→** and press **C**. The sub menu appears.
2. Use **←↓↑→** to select the desired setting icon and press **C**. The setting menu appears.
3. Use **←↓↑→** to make all required adjustments and press **C** save the settings.

### 3 Exiting the Adjustment menu

1. To return to the main menu, select the <Return> icon or press **↻** twice, followed by **C**.
2. To exit the Adjustment menu, select <Exit> icon or press **↻** twice, followed by **C**.

### Tips

- Double clicking **C** at any time also exits the Adjustment menu.

## Functions

The following table shows all the Adjustment menu's adjustment and setting menus. "\*" indicates adjustments of analog input only and "\*\*\*" indicates digital input only.

Main menu	Sub menu		Reference	
Screen	Clock	*	3-2. Screen Adjustment	
	Phase	*		
	Position	*		
	Resolution	*		
	Range Adjustment	*		
	Smoothing			
	Signal Filter	*		
Color (Custom)* <sup>1</sup>	Brightness		3-3. Color Adjustment	
	Temperature			
	Gamma			
	Saturation			
	Hue			
	Gain			
	6 Colors			
	Reset			
PowerManager	DVI DMPM	**	3-4. Power-save Setup	
	VESA DPMS	*		
	OFF			
Others	Screen Size		3-9. Displaying Lower Resolutions	
	Border Intensity			
	Input Priority		Select the Priority Input Signal.	
	Off Timer		Set the monitor's Off Timer to on or off.	
	Beep		Set the monitor's beeper to on or off. (Beeper settings.)	
	Menu Settings	Menu Size		Change the size of the menu.
		Menu Position		Adjust the menu position.
		Menu Off Timer		Set the menu displaying time.
		Translucent		Set the transparency of the background.
		Orientation		Set the orientation of the Adjustment menu.
	BrightRegulator		Set automatic brightness adjustment.	
	Power Indicator		Make non-light for blue lighting when the screen is displayed. ( Power Indicator Setting. )	
	Reset		Return to the factory Default settings.	
Information	Information		Review the Adjustment menu's settings, model name, serial number and usage time.* <sup>2</sup>	
Language	English, German, French, Spanish, Italian, Swedish, Chinese(Simplified), Chinese(Traditional) and Japanese		Select the Adjustment menu's language.	

\*<sup>1</sup>The adjustable functions on the <Color> menu depend on the selected FineContrast mode. The above table shows the sub menus when the "Custom" mode is selected (See " 3-3. Color Adjustment ").

\*<sup>2</sup>Due to the inspection on the factory, the usage time may not "0 hour" at shipping.

## 3-2. Screen Adjustment

### NOTE

- Allow the LCD monitor to stabilize for at least 30 minutes before making image adjustments.

The monitor displays the digital input image correctly based on its pre-setting data.

### Analog Input

The monitor screen adjustment is used to suppress flickering of the screen or adjust screen position and screen size correctly according to the PC to be used.

To use the monitor comfortably, adjust the screen when the monitor is set up for the first time or when the settings of the PC in use are updated.

### Adjustment Procedure

#### 1 Press **A** on the control panel.

The message "Your setting will be lost if you press again now." appears and remains on the screen for 5 seconds. While the message is on the screen, press the Auto Adjustment button again to automatically adjust the clock, phase, screen position and resolution. If you do not wish to do adjust the screen, do not press **A** again.

### NOTE

- The Auto adjustment function is intended for use on the Macintosh and on AT-compatible PC running Windows. It may not work properly in either of the following cases. It does not work properly when an image is displayed only on a part of the screen (command prompt window, for example) or when a black background (wallpaper, etc.) is in use.
- It cannot work correctly using with some graphics cards.

If the appropriate screen cannot be made by using **A**, adjust the screen through the following procedures. If the appropriate screen can be made, proceed to 5. Range Adjustment .

#### 2 Prepare the display pattern for the analog display adjustment.

Load the "EIZO LCD Utility Disk" to your PC, and then open the "Screen adjustment pattern files".

### Tips

- For details and instructions on opening the "Screen adjustment pattern files", refer to the Readme.txt file.

### 3 Perform the auto size adjustment again with the analog screen adjustment pattern displayed.

1. Display Pattern 1 in full screen on the monitor using the “Screen adjustment pattern files”.

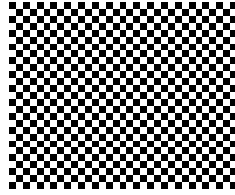

2. Press **A**.

A message “Your setting will be lost, if you press again now” appears for five seconds.

3. Press **A** again while the message is displayed.

The Auto Adjustment function begins (showing a running status icon) to adjust flickering, screen position, and screen size automatically.

### 4 Adjust by using <Screen> menu in the Adjustment menu

- (1) Vertical bars appear on the screen

→ Use the <Clock> adjustment.

Select the <Clock> and eliminate the vertical bars by using **▶** and **◀** of the Control buttons.

Do not continuously press the Control buttons, as the adjustment value will change quickly and make it difficult to locate the most suitable adjustment point. If the horizontal flickering, blur or bars appear, proceed to <Phase> adjustment as follows.

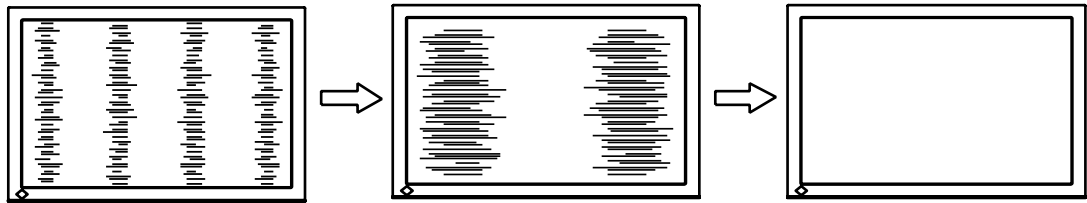

- (2) Horizontal flickering, blurring or bars appear on the screen.

→ Use the <Phase> adjustment.

Select the <Phase> and eliminate the horizontal flickering, blurring or bars by using **▶** and **◀** buttons.

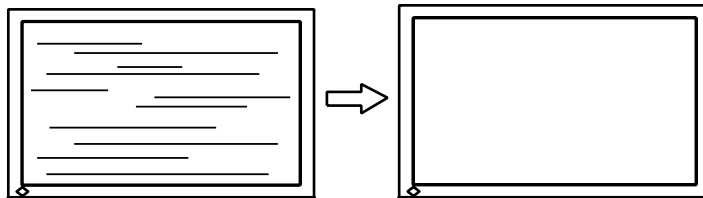

#### NOTE





- Horizontal bars may not completely disappear from the screen depending on the PC.



(3) The screen position is incorrect.

→  Use the <Position> adjustment.

The correct displayed position of the monitor is decided because the number and the position of the pixels are fixed. The <Position> adjustment moves the image to the correct position.



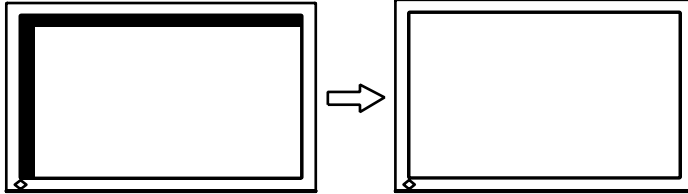

Select <Position> and adjust the position by using , ,  and . If vertical bars of distortion appear after finishing the <Position> adjustment, return to <Clock> adjustment and repeat the previously explained adjustment procedure. ("Clock" => "Phase" => "Position")



(4) Screen image is smaller or larger than the actual screen images.

→  Use the <Resolution> adjustment.

Adjustment is needed when the input signal resolution and the resolution now being displayed are different.

Select <Resolution> and confirm if the resolution now being displayed is the same as the input resolution. If it is not, adjust the vertical resolution using  and  and adjust the horizontal resolution using  and .

Smaller than the actual screen images.

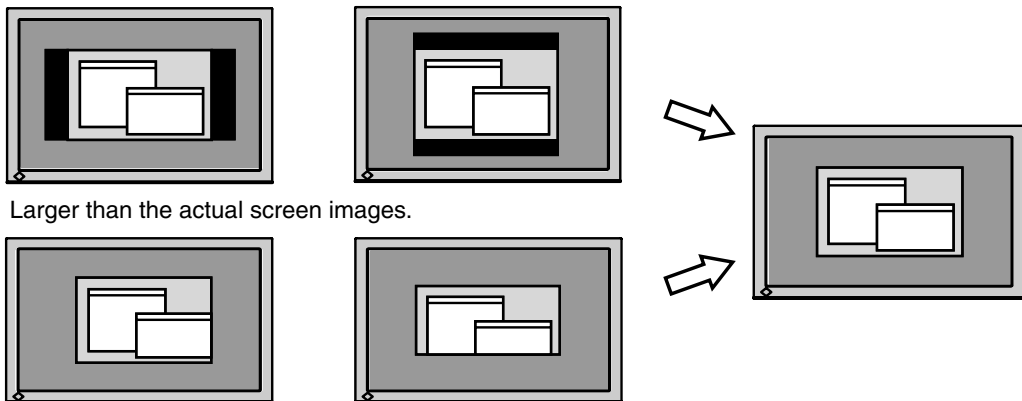

Larger than the actual screen images.

## 5 Adjust the output signal range (Dynamic Range) of the signal.

→  Use the <Range Adjustment> of <Screen> menu.

This controls the level of output signal range to display the whole color gradation (256 colors).  
[Procedure]

1. Display Pattern 2 in full screen on the monitor using the "Screen adjustment pattern files".

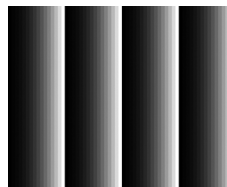

2. Choose <Range Adjustment> from the <Screen> menu, and press .

A message "Your setting will be lost if you press AUTO button" appears.

3. Press  while the message is displayed.

Color gradation is adjusted automatically.

4. Close the Pattern 2.

## 3-3. Color Adjustment

### Simple adjustment [FineContrast mode]

This function allows you to select the best display mode for monitor brightness, etc.

#### To Select FineContrast mode

Directly pressing **M** allows you to select the best suited mode for screen display from 4 FineContrast modes; Custom, sRGB, EMU and CAL. Color settings each mode can be adjusted by using the <Color> menu of the Adjustment menu.

Press **○** to exit the menu.

->Custom -> sRGB -> EMU -> CAL

#### Tips

- The Adjustment menu and the FineContrast menu cannot be displayed at the same time.

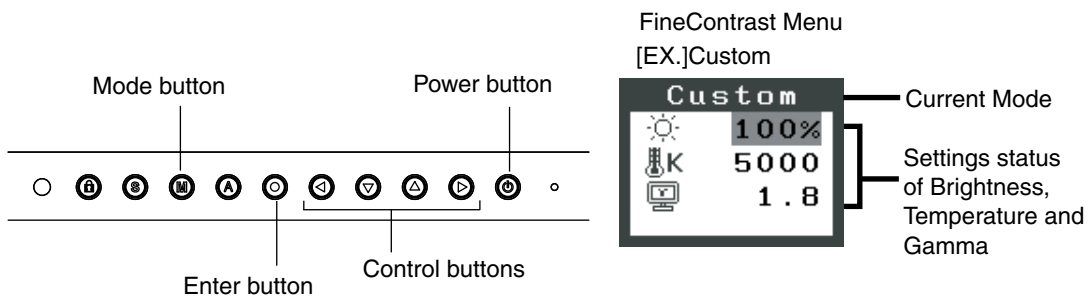

#### FineContrast Mode

Selectable FineContrast modes are as follows.

Mode	Purpose
Custom	To adjust the color settings according to your preference.
sRGB	To display the screen images based on those original colors (ex. over the Internet).
EMU	The mode only for calibration software.
CAL	

#### Color Adjustment of the Mode Settings

<Brightness>, <Temperature> and <Gamma> settings can be adjusted on the FineContrast menu. Select the desired function icon with **▽** and **△** and adjust with **◀** and **▶** Control buttons. (Setting(s) of <Temperature> and/or <Gamma> is defined as standard default in some modes.)

#### NOTE

- "CAL" mode and "EMU" mode can be adjusted only by Color Management Software "ColorNavigator".

## Advanced Adjustments [Adjustment menu]









Color settings of each FineContrast mode can be adjusted and saved by using the <Color> menu of the Adjustment menu.

In the analog input, perform the "Range Adjustment" before making the color adjustments. During color adjustments, the FineContrast mode cannot be changed. Select the mode in advance by using 

### Adjustment Items

The adjustable items and displayed icons on the <Color> menu depend on the selected FineContrast mode.

"√": Settable/Adjustable " - ": Fixed at the factory









Icons	Functions	FineContrast Mode			
		Custom	sRGB	EMU	CAL
	Brightness*	√	√	-	-
	Temperature*	√	-	-	-
	Gamma*	√	-	-	-
	Saturation	√	-	-	-
	Hue	√	-	-	-
	Gain	√	-	-	-
	6 Colors	√	-	-	-
	Reset	√	-	-	-

\* These settings can be also adjusted on the FineContrast menu. (See FineContrast.)

### NOTE

- Allow the LCD monitor to stabilize for at least 30 minutes before making image adjustments. (Allow the monitor to warm up for at least 30 minutes before making adjustments.)
- The values shown in percentages represent the current level within the specific adjustment. They are available only as a reference tool. (To create a uniform white or black screen, the percentages for each will probably not be the same.)

Adjustment Contents

Menu	Function Descriptions	Adjustable range
Brightness 	To set the brightness of the screen	0~100%
	<b>Tips</b> • The values shown in the “%” are available only as reference.	
Temperature 	To set the color temperature	4000K~10000K in 500 K increments (including 9300 K)
	<b>Tips</b> • The values shown in the Kelvin are available only as a reference tool. • While color temperature is adjusted, <Gain> is adjusted automatically according to the color temperature. • Setting the temperature under 4000 K or over 10000 K invalidates the color temperature setting. (The color temperature's setting turns "Off".) • Setting the <Gain> invalidates the <Temperature> adjustment.	
Gamma 	To set the gamma value	1.8~2.6
	<b>Tips</b> • If setting the gamma value, the using the monitor in the digital signal input is recommended. If using the monitor in the analog input signal, set the gamma value from 1.8 to 2.2.	
Saturation 	To change the saturation	-100~100 Setting the minimum level (-100) turns the image to the monochrome.
	<b>NOTE</b> • The <Saturation> adjustment may cause undisplayable color tone.	
Hue 	To change the flesh color, etc.	-100~100
	<b>NOTE</b> • Using <Hue> adjustment may not obtain proper tone reproduction.	
Gain 	To change each color (red, green and blue)	0~100% By adjusting the red, green and blue color tones for each mode, custom colors can be defined. Display a white or gray background image and adjust the <Gain>.
	<b>Tips</b> • The values shown in the “%” are available only as reference. • The <Temperature> setting invalidates this setting. The <Gain> setting varies with color temperature.	
6 colors 	To adjust <Saturation> and <Hue> in each color (Red, Yellow, Green, Cyan, Blue and Magenta)	Hue: -100 ~ 100 Saturation: -100 ~ 100
Reset 	To return the color settings to the default settings	Select the <Reset>.

## 3-4. Power-save Setup

The <PowerManager> menu in the Adjustment menu enables to set the power-save setup.

### NOTE

- Do your part to conserve energy, turn off the monitor when you are finished using it. Disconnecting the monitor from the power supply is recommended to save energy completely.
- Even if the monitor is in a power saving mode, USB compliant devices function when they are connected to the monitor's USB (both the upstream and the downstream ports). Therefore, power consumption of the monitor will change according to the connected devices even if the monitor is in a power saving mode.

## Analog Input

This monitor complies with the "VESA DPMS" standard and adopts a power saving method.

### [Procedure]

1. Set the PC's power saving settings.
2. Select "VESA DPMS" from the <PowerManager> menu.

### [Power Saving System]

PC		Monitor	Power Indicator
Operation		Operation	Blue
Power saving	STAND-BY SUSPEND OFF	Power saving	Orange

### [Power Resumption Procedure]

Operate the mouse or keyboard to return to a normal screen.

## Digital Input

This monitor complies with the "DVI DMPM"

### [Procedure]

1. Set the PC's power saving settings.
2. Select "DVI DMPM" from the <PowerManager> menu.

### [Power Saving System]

The monitor enters the power saving mode in five seconds in connection with the PC setting.

PC		Monitor	Power Indicator
Operation		Operation	Blue
Power saving		Power saving	Orange

### [Power Resumption Procedure]

Operate the mouse or keyboard to return to a normal screen.

## 3-5. Off Timer

The off timer function causes the monitor to automatically enter a power off state after a predetermined amount of time has lapsed. This function was created to reduce Afterimage characteristics that are particular to LCD monitors when the monitor screen is left on for a long period without use.

### [Procedure]

1. Select <Off Timer> in the Adjustment menu <Others> menu.
2. Select "Enable and touch the Right and Left directing switches to adjust the operating time (1 to 23 hours).

### [Off Timer System]

PC	Monitor	Power Indicator
Operating time (1H - 23H)	Operation	Blue
Last 15 min. in operating time	Advance Notice *1	Blue Flashing
Operating time expired	Power Off	Off

\*1 When  is pressed during the advance notice period, the monitor continues to operate for additional 90 minutes. Extension of operation time can be set without limitation.

### [Power Resumption Procedure]











Press  to return a normal screen.

### NOTE

- The off timer function works while the PowerManager is active, but there is no advance notice before the monitor's power is turned off.

## 3-6. Locking the settings

Use the "Adjustment Lock" function to prevent any accidental changes.

Buttons that can be locked	<ul style="list-style-type: none"> <li>•  (Enter button) / Adjustments/settings using</li> <li>•  (Mode button)</li> <li>•  (Auto Adjustment button)</li> <li>•  +  EIZO Logo display setup (P. 25)</li> <li>•  +  Signal Selection (P. 30)</li> </ul>
Buttons that cannot be locked	<ul style="list-style-type: none"> <li>•  (Input Signal Selection button)</li> <li>•  (Power button)</li> <li>•  (Adjustment Lock button)</li> </ul>

### [How to lock]

Press  for at least 2 seconds to lock the settings.

### [How to unlock]

Press  for at least 2 seconds to release the lock.

---

## 3-7. Power Indicator Setting

---

Light off the power indicator. This function is available for the multiple panels settings.

### [Procedure]

1. Select <Power Indicator> in the Adjustment menu <Others> menu.
2. Select "Disable".

## 3-8. Automatic brightness adjustment

---

The sensor on the front side of the monitor detects the environmental brightness to adjust the screen brightness automatically and comfortably.

### [Procedure]

1. Select <BrightRegulator> in the Adjustment menu <Others> menu.
2. Select "Enable".

---

### **NOTE**



- This function is not available in the EMU and CAL modes.
-

## 3-9. Displaying Lower Resolutions

The lower resolutions are enlarged to full screen automatically. Using the <Screen Size> function in the <Others> menu enables to change the screen size.

### 1 Enlarge the screen size when displaying a low resolution.

→  Select the <Screen Size>.

Select the <Screen Size> in the <Others> menu and select the screen size by using  and .

Mode	Function
Full	Displays the picture on the screen in full, irrespective of the picture's resolution. Since the vertical resolution and the horizontal resolution are enlarged at different rates, some images may appear distorted.
Enlarged	Displays the picture on the screen in full, irrespective of the picture's resolution. Since the vertical resolution and horizontal resolution are enlarged at same rates, some horizontal or vertical image may disappear.
Normal	Displays the picture at the actual Screen resolution.

Example: Displaying 1280 x 1024

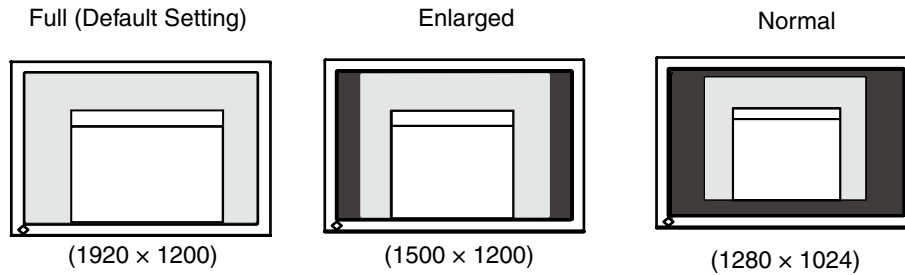

### 2 Smooth the blurred texts of the enlarged screen.

→  Switch the <Smoothing> setting.

When a low-resolution image is displayed in the "Full" or "Enlarged" mode, the characters or lines of the displayed image may be blurred.

Select the suitable level from 1 - 5 (Soft - Sharp).

Select <Smoothing> in the <Screen> menu and adjust by using the right and left switches.



#### NOTE

- <Smoothing> is disabled in the following cases.
  - Screen is displayed in the 1920 x 1200.
  - "Enlarged" is selected in <Screen Size> at 800 x 600 resolution.
  - "Enlarged" is selected in <Screen Size> at 1600 x 1200 resolution.
  - "Normal" is selected in <Screen Size>.



### 3 Set the brightness of the black area surrounding the displayed image.

→  Set the <Border Intensity>.

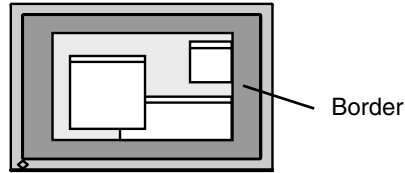

In the "Enlarge" mode or "Full Screen" mode, the outer area (border) is usually black. Select <BorderIntensity> in the <Others> menu and adjust by using  .



## 3-10. Setting the orientation of the Adjustment menu

The orientation of the Adjustment menu can be changed.



### [Procedure]

1. Select <Orientation> in the Adjustment menu <Others> menu.
2. Use   to select between "Portrait" and "Landscape".



## 3-11. EIZO Logo Appearing Function

When switching on the power button on the front control panel, the EIZO logo is displayed for a while. If you desire to display or undisplay this logo, use this function. (Default is logo appearing.)

### [To undisplay]

1. Press  to turn off the unit.
  2. Press  again while pressing .
- The EIZO logo does not appear on the screen.







### [To display]

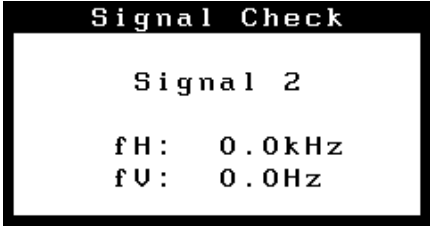

1. Press  to turn off the unit.
  2. Press  again while pressing .
- The EIZO logo appear on the screen.

# 4. Troubleshooting

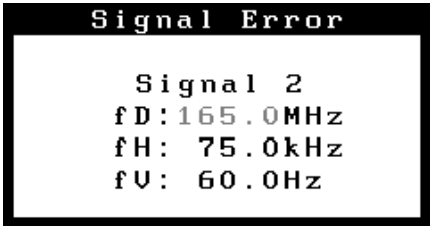
If a problem still remains after applying the suggested remedies, contact your local dealer.

- No-picture problems : See No.1 - No.2
- Imaging problems : See No.3 - No.14
- Other problems : See No.15 - No.18
- USB problems : See No.19 - No.20

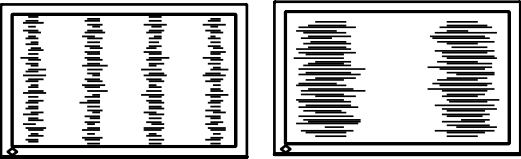
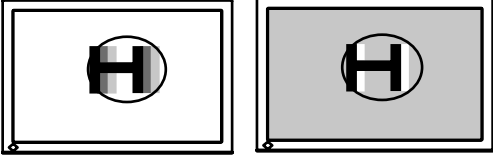
Problems	Possible cause and remedy
<p>1. No picture</p> <ul style="list-style-type: none"> <li>• Power indicator does not light.</li> <li>• Power indicator is lighting blue.</li> <li>• Power indicator is lighting orange.</li> </ul>	<ul style="list-style-type: none"> <li>• Check whether the power cord is connected correctly. If the problem persists, turn off the monitor, and then turn it on again a few minutes later.</li> <li>• Press .</li> <li>• Set each adjusting value in &lt;Brightness&gt; or &lt;Gain&gt; to higher level. (page 20).</li> <li>• Switch the input signal with .</li> <li>• Operate the mouse or keyboard.</li> <li>• Turn on the PC.</li> </ul>
<p>2. The message below appears.</p> <ul style="list-style-type: none"> <li>• This message appears when no signal is input. (This is displayed for about 40 seconds)</li> </ul> 	<p>This message appears when the signal is not input correctly even when the monitor functions properly.</p> <ul style="list-style-type: none"> <li>• The message shown left may appear, because some PCs do not output the signal soon after power-on.</li> <li>• Check whether the PC is turned on.</li> <li>• Check whether the signal cable is connected properly.</li> <li>• Switch the input signal with .</li> </ul>
<ul style="list-style-type: none"> <li>• The message below shows that the input signal is out of the specified frequency range. (Such signal frequency is displayed in red.)</li> </ul> <p>Example:</p> 	<ul style="list-style-type: none"> <li>• Reboot the PC.</li> <li>• Select an appropriate display mode using the graphics board's utility. Refer to the manual of the graphics board for details.</li> </ul> <p>fD: Dot Clock (Displayed only when the digital signal inputs)</p> <p>fH: Horizontal Frequency</p> <p>fV: Vertical Frequency</p>
<p>3. Display position is incorrect.</p> 	<ul style="list-style-type: none"> <li>• Adjust image position so that it is displayed properly within the display area using the &lt;Position&gt; adjustment (page 17).</li> <li>• If the problem persists, use the graphics board's utility if available to change the display position.</li> </ul>

Problems	Possible cause and remedy
4. Screen image displayed is smaller or larger than the actual screen image.	<ul style="list-style-type: none"> <li>Adjust the resolution using &lt;Resolution&gt; so that the input signal resolution equals the resolution in the resolution adjustment menu (page 17).</li> </ul>
5. Vertical bars appear on the screen or a part of the image is flickering. 	<ul style="list-style-type: none"> <li>Adjust using &lt;Clock&gt; (page 16).</li> </ul>
6. The characters and images have several vertical bars on their right side. 	<ul style="list-style-type: none"> <li>Adjust the characters and images using the &lt;Signal Filter&gt;.</li> </ul>
7. Whole screen is flickering or blurring. 	<ul style="list-style-type: none"> <li>Adjust using &lt;Phase&gt; (page 16).</li> </ul>
8. Characters are blurred.	<ul style="list-style-type: none"> <li>Adjust using &lt;Smoothing&gt; (page 24).</li> </ul>
9. Upper part of the screen is distorted as shown below. 	<ul style="list-style-type: none"> <li>This is caused when both composite sync (X-OR) signal and separate vertical sync signal are input simultaneously. Select either composite signal or separate signal</li> </ul>
10. The screen is too bright or too dark.	<ul style="list-style-type: none"> <li>Adjust &lt;Brightness&gt;. (The LCD monitor backlight has a fixed life span. When the screen becomes dark or begins to flicker, contact your local dealer.)</li> </ul>
11. Afterimages appear.	<ul style="list-style-type: none"> <li>Use a screen saver or off timer function for a long-time image display.</li> <li>Afterimages are particular to LCD monitors. Avoid displaying the same image for a long time.</li> </ul>
12. Green/red/blue/white dots or defective dots remain on the screen.	<ul style="list-style-type: none"> <li>This is due to LCD panel characteristics and is not a failure.</li> </ul>
13. Interference patterns or fingerprints remain on the screen.	<ul style="list-style-type: none"> <li>Leave the monitor with a white screen or a black screen. The symptom may disappear.</li> </ul>
14. Noise appears on the screen.	<ul style="list-style-type: none"> <li>When entering the signals of analog input, select 1 to 4 in &lt;Signal Filter&gt; from the &lt;Screen&gt; menu to change the mode.</li> <li>When entering the signals of HDCP system, the normal images may not be displayed immediately.</li> </ul>

## 4. Troubleshooting

Problems	Possible cause and remedy
15.The <Smoothing> icon on the Adjustment menu <Screen> cannot be selected.	<ul style="list-style-type: none"> <li>• &lt;Smoothing&gt; is disabled when the screen is displayed in the following resolutions.</li> <li>• 1920 × 1200</li> <li>• Select "Enlarged" during &lt;Screen Size&gt; in the resolution of 800 × 600</li> <li>• Select "Enlarged" during &lt;Screen Size&gt; in the resolution of 1600 × 1200</li> <li>• Select "Normal" during &lt;Screen Size&gt; mode.</li> </ul>
16.The Main menu of Adjustment menu does not start.	<ul style="list-style-type: none"> <li>• Check for Adjustment Lock function (page 22).</li> </ul>
17.The FineContrast mode is not displayed.	<ul style="list-style-type: none"> <li>• Check for Adjustment Lock function (page 22).</li> </ul>
18.Ⓐ does not function.	<ul style="list-style-type: none"> <li>• Ⓐ does not function when digital signal is input.</li> <li>• Check for Adjustment Lock function (page 22).</li> </ul>
19.PC is hung up. / The peripherals connected to the downstream ports do not operate.	<ul style="list-style-type: none"> <li>• Check that the USB cable is correctly connected.</li> <li>• Check the downstream ports by connecting the peripherals to other downstream ports. If the problem is solved by doing this, contact an EIZO dealer. (For details, refer to the manual of the PC.)</li> <li>• Try executing the following method. <ul style="list-style-type: none"> <li>• Restarting the PC</li> <li>• Connecting the PC and peripherals directly</li> </ul> </li> </ul> <p>If the problem is solved by doing this, contact an EIZO dealer.</p>
20.USB function cannot be setup.	<ul style="list-style-type: none"> <li>• Check that the USB cable is correctly connected.</li> <li>• Check that the PC and OS are USB compliant. (For verification of USB support, consult the manufacturer of each system.)</li> <li>• Check the PC's BIOS setting for USB. (For details, refer to the manual of the PC.)</li> </ul>

## 5. Reference

### 5-1. Attaching an arm

The LCD monitor can be used with an arm by removing the tilt stand and attaching the arm stand to the LCD monitor.

#### NOTE

- If you will use the arm or stand of other manufacturers, confirm the followings to the manufacturers before selecting.
  - Hole spacing on the arm mounting  
100 mm x 100 mm (VESA compliant)
  - Supportable Weight: Total weight of the monitor (without stand) and attaching equipment such as a cable
  - TÜV/GS approved arm or stand
- Please connect cables after attaching an arm stand.

#### Setup Procedure

**1** Lay the LCD monitor down. Do not scratch the panel.

**2** Remove the tilt stand by loosening the screws.

Unscrew the four screws securing the unit and the stand with the screwdriver.

**3** Attach an arm stand to the LCD monitor securely.

Secure the monitor to the arm or stand using the screws specified in the user's manual of the arm or stand.

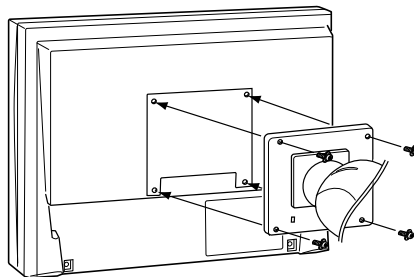









## 5-2. Environmental Settings (Digital signals only)

Depending upon your operating environment, it may be necessary to set the frequency that corresponds to your graphics board. If you install it for the first time or change environment, set the monitor.

### NOTE

- Refer to the manual of the graphics board.
- These environment described below can be set regardless of whether or not the computer is running.

### How to set

- 1 Press  to turn off the unit.
- 2 Press  again while pressing .
- 3 Select the input signal using the  in the <Signal Selection> menu at the center of the monitor.  
Use  to select (or just confirm) the frequency that corresponds to your graphics board, and then press .  
- Normal:  
Horizontal scanning frequency : 31 - 76kHz  
Vertical scanning frequency : 59 -61Hz  
- Wide:  
Horizontal scanning frequency : 26 - 78kHz  
Vertical scanning frequency : 47.5 -63Hz

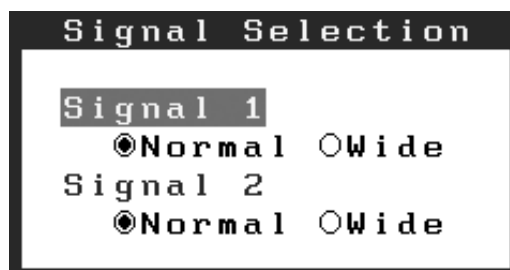

- 4 Restart the computer if the settings have been changed.

---

## 5-3. Cleaning

---

Periodic cleaning is recommended to keep the monitor looking new and to prolong its operation lifetime.

**NOTE**

- Never use thinner, benzene, alcohol (ethanol, methanol, or isopropyl alcohol), abrasive cleaners, or other strong solvents, as these may cause damage to the cabinet or LCD panel.
- 

### Cabinet

To remove stains, wipe the cabinet with a soft, lightly moistened cloth using a mild detergent. Do not spray wax or cleaner directly into the cabinet. (For details, refer to the manual of the PC.)

### LCD Panel

- The LCD surface can be cleaned with a soft cloth, such as cotton or lens paper.
- If necessary, stubborn stains can be removed by using the provided ScreenCleaner, or moistening part of a cloth with water to enhance its cleaning power.

## 5-4. Specifications

LCD Panel		61 cm (24.1 inch), TFT color LCD panel Surface treatment : Anti-Glare Hard Coating Surface hardness : 3H Response Time : 16ms
Viewing Angle		Horizontal : 178°, Vertical : 178°(CR: 10 or more)
Dot Pitch		0.270mm
Horizontal Scan Frequency	Analog	24~94 kHz (Automatic)
	Digital	26~78 kHz
Vertical Scan Frequency	Analog	47.5~86Hz (Automatic) (1600x1200 : 47.5 ~ 76Hz) (1920x1200 : 47.5 ~ 61Hz)
	Digital	47.5 ~ 63 Hz (VGA TEXT: 69 ~ 71 Hz)
Resolution		1920 dots x 1200 lines
Dot Clock (Max.)	Analog	202.5MHz
	Digital	164.5MHz
Display Colors		16.77 million colors (max.)
Recommended Brightness		120cd/m <sup>2</sup> or less (with color temperature of between 5000K to 6500K)
Display Area		518.4 mm (H) x 324.0 mm (V) (20.4" (H) x 12.8" (V))
Power Supply		100-120/200-240 VAC±10%, 50/60 Hz, 1.1 A/0.55A
Power Consumption		Max. : 110 W (with USB) Min. (Normal) : 100W (without USB) Power Saving Mode : Less than 2 W (for single signal input without USB)
Input Signal Connector		DVI-I connector (Applicable to HDCP)×2
Analog Input Signal (Sync)		Separate, TTL, Positive/Negative
		Composite, TTL, Positive/Negative
Analog Input Signal (Video)		0.7 Vp-p / 75 ohms, Positive
Input Signal (Digital)		TMDS (Single Link)
Signal registration	Analog	45 (Factory preset: 30)
	Digital	10 (Factory preset: 0)
Plug & Play		VESA DDC 2B / EDID structure 1.3
Dimensions	with stand	566 mm (W) x 456 ~ 538 mm (H) x 230 mm (D) (22.3"(W) x 18" ~ 21.2" (H) x 9.1"(D))
	without stand	566 mm (W) x 367 mm (H) x 85 mm (D) (22.3"(W) x 14.4" (H) x 3.35"(D))
	with hood	571 mm (W) x 462 ~ 544 mm (H) x 347.6 mm (D) (22.5"(W) x 18" ~ 21.4" (H) x 13.7"(D))
Weight	with stand	11.0kg (24.3 lbs.)
	without stand	7.4kg (16.3 lbs.)
	with hood	11.8kg (26 lbs.)
Environment Conditions	Temperature	Operating : 0°C ~ 35°C (32°F ~ 95°F) Storage : -20°C ~ 60°C (-4°F ~ 140°F)
		Humidity
	Pressure	
USB	standard	USB Specification Revision 2.0
	USB port	Upstream port x 1 Downstream port x 2
	Communication Speed	480 Mbps (high), 12 Mbps (full), 1.5 Mbps (low)
	Power Supply	Downstream: 500 mA for each (max.)



## Default settings

Brightness		37%
Smoothing		3
Temperature		6500K
FineContrast Mode		Custom
PowerManager		Analog input : VESA DPMS Digital input:DVI DMPM
Screen Size		Full
Input Priority		1
Off Timer		Disable
Menu Settings	Menu Size	Normal
	Menu Off Timer	45 sec
BrightRegulator		Disable
Beep		On
Language		English
Signal Selection		Normal

## Beeper settings

Short beep	Adjustment menu item selselected. Adjustment menu parameter adjusted to minimum or maximum limit. Ⓢ pressed When locked or unlocked with ⓐ
Long beep	ⓐ pressed Adjustment menu data-save executed.
4 short beeps	Monitor not connected correctly. PC turned off. Monitor received unsupported signal frequency.
2 short beeps every 15 sec.	Monitor is in the advance notice mode of the Off Timer. The power will be off within fifteen minutes.

## Dimensions

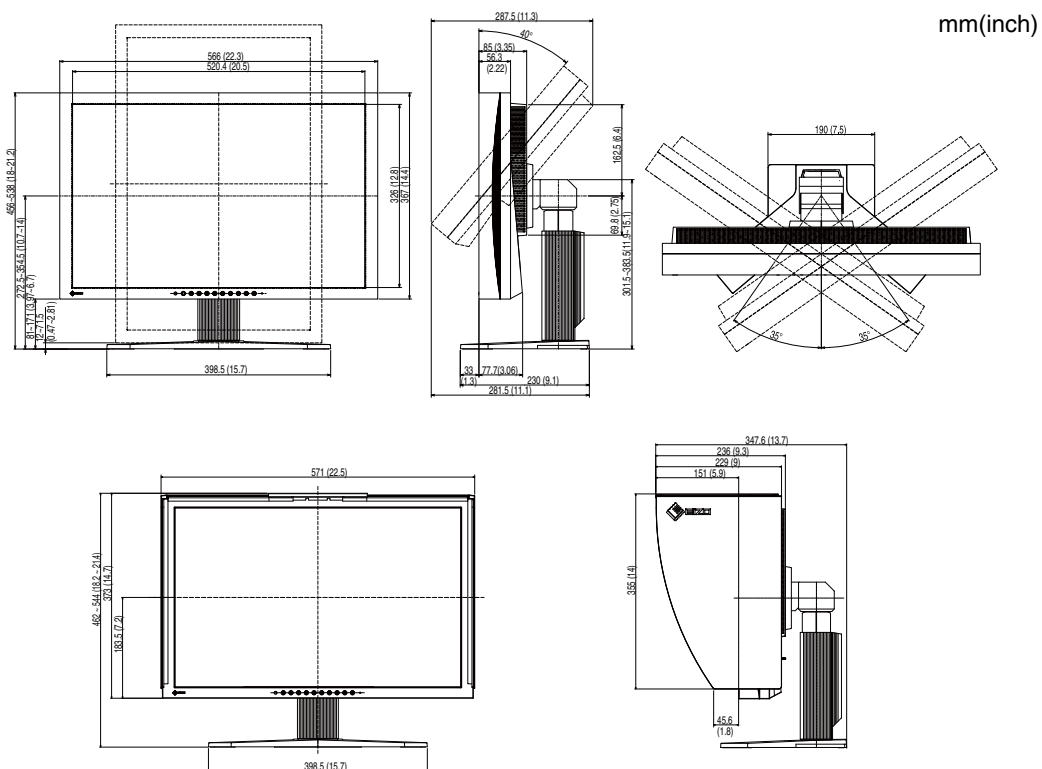

## Pin Assignment

•DVI-I Connector

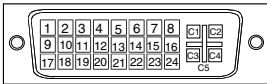

Pin No.	Signal	Pin No.	Signal	Pin No.	Signal
1	TMDS Data 2-	11	TMDS Data1/3 Shield	21	NC*
2	TMDS Data 2+	12	NC*	22	TMDS Clock shield
3	TMDS Data2/4 Shield	13	NC*	23	TMDS Clock+
4	NC*	14	+5V Power	24	TMDS Clock-
5	NC*	15	Ground (return for +5V, Hsync and Vsync)	C1	Analog Red
6	DDC Clock (SCL)	16	Hot Plug Detect	C2	Analog Green
7	DDC Data (SDA)	17	TMDS Data0-	C3	Analog Blue
8	Analog Vertical Sync	18	TMDS Data0+	C4	Analog Horizontal Sync
9	TMDSData1-	19	TMDS Data0/5 Shield	C5	Analog Ground(analog R,G,&B return)
10	TMDS Data1+	20	NC*		

(\*NC: No Connection)

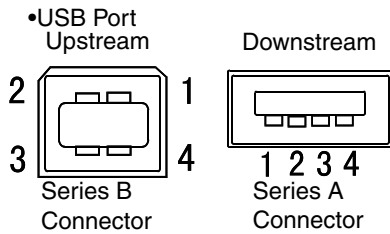

No.	Signal	Remarks
1	VCC	Cable power
2	- Data	Serial data
3	+ Data	Serial data
4	Ground	Cable Ground

---

## 5-5. Glossary

---

### **Clock**

With the analog input signal display, the analog signal is converted to a digital signal by the LCD circuitry. To convert the signal correctly, the LCD monitor needs to produce the same number clock pulse as the dot clock of the graphics system. When the clock pulse is not correctly set, some vertical bars of distortion are displayed on the screen.

### **DVI (Digital Visual Interface)**

A digital flat panel interface. DVI can transmit digital data from the PC directly without loss with the signal transition method "TMDS". There are two kinds of DVI connectors. One is DVI-D connector for digital signal input only. The other is DVI-I connector for both digital and analog signal inputs.

### **DVI DMPM (DVI Digital Monitor Power Management)**

The Power management system for the digital interface. The "Monitor ON" status (operation mode) and the "Active Off" status (power-saving mode) are indispensable for the DVI-DMPM as the monitor's power mode.

### **Gain Adjustment**

Adjusts each color parameter for red, green and blue. The color of the LCD monitor is displayed through the color filter of the LCD panel. Red, green and blue are the three primary colors. The colors on the monitor are displayed by combining these three colors. The color tone can change by adjusting the illumination amount passed through each color's filter.

### **Gamma**

Generally, the relationship that the light intensity values of a monitor change nonlinearly to the input signal level is called "Gamma Characteristic". On the monitor, low gamma values display the whitish images and high gamma values display the high contrast images.

### **HDCP (High-bandwidth Digital Contents Protection)**

Digital signal coding system developed to copy-protect the digital contents, such as video, music, etc. This helps to transmit the digital contents safely by coding the digital contents sent via DVI terminal on the output side and decoding them on the input side.

Any digital contents cannot be reproduced if both of the equipments on the output and input sides are not applicable to HDCP system.

### **Phase**

The phase adjustment decides the sampling timing point for converting the analog input signal to a digital signal. Adjusting the phase after the clock adjustment will produce a clear screen.

### **Range Adjustment**

The Range Adjustment controls the level of output signal range to display the whole color gradation.

## **Resolution**

The display panel of this monitor consists of 1920 horizontal pixels and 1200 vertical pixels. At a resolution of 1920 x 1200, images are displayed as a full screen (1:1).

## **sRGB (Standard RGB)**

"International Standard for Red, Green, and Blue color space" A color space was defined with the aim of the color matching between applications and hardware devices, such as monitors, scanners, printers and digital cameras. As a standard default space, sRGB allows Internet users to closely match colors.

## **Temperature**

Color Temperature is a method to measure the white color tone, generally indicated in degrees Kelvin. At high temperatures the white tone appears somewhat blue, while at lower temperatures it appears somewhat red. Computer monitors generally give best performance at high temperature settings.

5000 K: Slightly reddish white (usually used in print industry)

6500 K: White called daylight color (suited for web browsing)

9300 K: Slightly bluish white (usually used for television)

## **TMDs (Transition Minimized Differential Signaling)**

A signal transition method for the digital interface.

## **VESA DPMS**

### **(Video Electronics Standards Association - Display Power Management Signaling)**

The acronym VESA stands for "Video Electronics Standards Association", and DPMS stands for "Display Power Management Signaling". DPMS is a communication standard that PCs and graphics boards use to implement power savings on the monitor side.

# 6. APPENDIX/ANHANG/ANNEXE

## Preset Timing Chart for Analog input Timing-Übersichten für Analog Eingang Synchronisation des Signaux pour Analog numerique

### NOTE

- Based on the signal diagram shown below factory presets have been registered in the monitor's microprocessor.
- Der integrierte Mikroprozessor des Monitors unterstützt werkseitige Standardeinstellungen (siehe hierzu die nachfolgenden Diagramme).
- Signaux ont été enregistrés en usine dans le microprocesseur du moniteur, conformément au diagramme de synchronisation ci-dessous.

Mode	Dot Clock MHz		Frequencies	
			Horizontal:kHz	Vertical:Hz
VGA 640×480@60Hz	25.2 MHz	Horizontal	31.47	Negative
		Vertical	59.94	Negative
VGA TEXT 720×400@70Hz	28.3 MHz	Horizontal	31.47	Negative
		Vertical	70.09	Positive
Macintosh 640×480@67Hz	30.2 MHz	Horizontal	35.00	Negative
		Vertical	66.67	Negative
Macintosh 832×624@75Hz	57.3 MHz	Horizontal	49.73	Negative
		Vertical	74.55	Negative
Macintosh 1152×870@75Hz	100.0 MHz	Horizontal	68.68	Negative
		Vertical	75.06	Negative
Macintosh 1280×960@75Hz	126.2 MHz	Horizontal	74.76	Positive
		Vertical	74.76	Positive
VESA 640×480@72Hz	31.5 MHz	Horizontal	37.86	Negative
		Vertical	72.81	Negative
VESA 640×480@75Hz	31.5 MHz	Horizontal	37.50	Negative
		Vertical	75.00	Negative
VESA 640×480@85Hz	36.0 MHz	Horizontal	43.27	Negative
		Vertical	85.01	Negative
VESA 800×600@56Hz	36.0 MHz	Horizontal	35.16	Positive
		Vertical	56.25	Positive
VESA 800×600@60Hz	40.0 MHz	Horizontal	37.88	Positive
		Vertical	60.32	Positive
VESA 800×600@72Hz	50.0 MHz	Horizontal	48.08	Positive
		Vertical	72.19	Positive
VESA 800×600@75Hz	49.5 MHz	Horizontal	46.88	Positive
		Vertical	75.00	Positive
VESA 800×600@85Hz	56.3 MHz	Horizontal	53.67	Positive
		Vertical	85.06	Positive
VESA 1024×768@60Hz	65.0 MHz	Horizontal	48.36	Negative
		Vertical	60.00	Negative
VESA 1024×768@70Hz	75.0 MHz	Horizontal	56.48	Negative
		Vertical	70.07	Negative
VESA 1024×768@75Hz	78.8 MHz	Horizontal	60.02	Positive
		Vertical	75.03	Positive
VESA 1024×768@85Hz	94.5 MHz	Horizontal	68.68	Positive
		Vertical	85.00	Positive
VESA 1152×864@75Hz	108.0 MHz	Horizontal	67.50	Positive
		Vertical	75.00	Positive
VESA 1280×960@60Hz	108.0 MHz	Horizontal	60.00	Positive
		Vertical	60.00	Positive
VESA 1280×1024@60Hz	108.0 MHz	Horizontal	63.98	Positive
		Vertical	60.02	Positive
VESA 1280×1024@75Hz	135.0 MHz	Horizontal	79.98	Positive
		Vertical	75.03	Positive
VESA 1280×1024@85Hz	157.5 MHz	Horizontal	91.15	Positive
		Vertical	85.03	Positive
VESA 1600×1200@60Hz	162.0 MHz	Horizontal	75.00	Positive
		Vertical	60.00	Positive
VESA 1600×1200@65Hz	175.0 MHz	Horizontal	81.25	Positive
		Vertical	65.00	Positive

Mode	Dot Clock MHz		Frequencies		Sync Polarity
			Horizontal:kHz	Vertical:Hz	
VESA 1600×1200@70Hz	189.0 MHz	Horizontal	87.50		Positive
		Vertical	70.00		Positive
VESA 1600×1200@75Hz	202.5 MHz	Horizontal	93.75		Positive
		Vertical	75.00		Positive
VESA CVT 1680×1050 60Hz	146.3 MHz	Horizontal	65.29		Negative
		Vertical	59.95		Positive
VESA CVT 1920×1200 60Hz	193.3 MHz	Horizontal	74.56		Negative
		Vertical	59.89		Positive
VESA CVT RB 1920×1200 60Hz	154.0 MHz	Horizontal	74.04		Positive
		Vertical	59.95		Negative



Congratulations!

The display you have just purchased carries the TCO'03 Displays label. This means that your display is designed, manufactured and tested according to some of the strictest quality and environmental requirements in the world. This makes for a high performance product, designed with the user in focus that also minimizes the Impact on our natural environment.

Some of the features of the TCO'03 Display requirements:

#### Ergonomics

- Good visual ergonomics and image quality in order to improve the working environment for the user and to reduce sight and strain problems. Important parameters are luminance, contrast, resolution, reflectance, colour rendition and image stability.

#### Energy

- Energy-saving mode after a certain time - beneficial both for the user and environment
- Electrical safety

#### Emissions

- Electromagnetic fields
- Noise emissions

#### Ecology

- The products must be prepared for recycling and the manufacturer must have a certified environmental management system such as EMAS or ISO 14000
- Restrictions on
  - chlorinated and brominated flame retardants and polymers
  - heavy metals such as cadmium, mercury and lead.

The requirements included in this label have been developed by TCO Development in co-operation with scientists, experts, users as well as manufacturers all over the world. Since the end of the 1980s TCO has been involved in influencing the development of IT equipment in a more user-friendly direction. Our labeling system with displays in 1992 and is now requested by users and IT-manufacturers all over the world.

**For more information, please visit  
[www.tcodevelopment.com](http://www.tcodevelopment.com)**

For U.S.A. , Canada, etc. (rated 100-120 Vac) Only

## FCC Declaration of Conformity

**We, the Responsible Party**

EIZO Inc.

5710 Warland Drive, Cypress, CA 90630

Phone: (562) 431-5011

**declare that the product**

Trade name: EIZO

Model: ColorEdge CG241W

**is in conformity with Part 15 of the FCC Rules. Operation of this product is subject to the following two conditions: (1) this device may not cause harmful interference, and (2) this device must accept any interference received, including interference that may cause undesired operation.**

This equipment has been tested and found to comply with the limits for a Class B digital device, pursuant to Part 15 of the FCC Rules. These limits are designed to provide reasonable protection against harmful interference in a residential installation. This equipment generates, uses, and can radiate radio frequency energy and, if not installed and used in accordance with the instructions, may cause harmful interference to radio communications. However, there is no guarantee that interference will not occur in a particular installation. If this equipment does cause harmful interference to radio or television reception, which can be determined by turning the equipment off and on, the user is encouraged to try to correct the interference by one or more of the following measures.

- \* Reorient or relocate the receiving antenna.
- \* Increase the separation between the equipment and receiver.
- \* Connect the equipment into an outlet on a circuit different from that to which the receiver is connected.
- \* Consult the dealer or an experienced radio/TV technician for help.

Changes or modifications not expressly approved by the party responsible for compliance could void the user's authority to operate the equipment.

### Note

Use the attached specified cable below or EIZO signal cable with this monitor so as to keep interference within the limits of a Class B digital device.

- AC Cord
- Shielded Signal Cable (Enclosed)

## Canadian Notice

This Class B digital apparatus complies with Canadian ICES-003.

Cet appareil numérique de la classe B est conforme à la norme NMB-003 du Canada.



### **Hinweise zur Auswahl des richtigen Schwenkarms für Ihren Monitor**

Dieser Monitor ist für Bildschirmarbeitsplätze vorgesehen. Wenn nicht der zum Standardzubehör gehörige Schwenkarm verwendet wird, muss statt dessen ein geeigneter anderer Schwenkarm installiert werden. Bei der Auswahl des Schwenkarms sind die nachstehenden Hinweise zu berücksichtigen:

Der Standfuß muß den nachfolgenden Anforderungen entsprechen:

- a) Der Standfuß muß eine ausreichende mechanische Stabilität zur Aufnahme des Gewichtes vom Bildschirmgerät und des spezifizierten Zubehörs besitzen. Das Gewicht des Bildschirmgerätes und des Zubehörs sind in der zugehörigen Bedienungsanleitung angegeben.
- b) Die Befestigung des Standfusses muß derart erfolgen, daß die oberste Zeile der Bildschirmanzeige nicht höher als die Augenhöhe eines Benutzers in sitzender Position ist.
- c) Im Fall eines stehenden Benutzers muß die Befestigung des Bildschirmgerätes derart erfolgen, daß die Höhe der Bildschirmmitte über dem Boden zwischen 135 – 150 cm beträgt.
- d) Der Standfuß muß die Möglichkeit zur Neigung des Bildschirmgerätes besitzen (max. vorwärts: 5°, min. nach hinten  $\geq 5^\circ$ ).
- e) Der Standfuß muß die Möglichkeit zur Drehung des Bildschirmgerätes besitzen (max.  $\pm 180^\circ$ ). Der maximale Kraftaufwand dafür muß weniger als 100 N betragen.
- f) Der Standfuß muß in der Stellung verharren, in die er manuell bewegt wurde.
- g) Der Glanzgrad des Standfusses muß weniger als 20 Glanzeinheiten betragen (seidenmatt).
- h) Der Standfuß mit Bildschirmgerät muß bei einer Neigung von bis zu 10° aus der normalen aufrechten Position kippstabil sein.

### **Hinweis zur Ergonomie :**

Dieser Monitor erfüllt die Anforderungen an die Ergonomie nach EK1-ITB2000 mit dem Videosignal, 1920 × 1200, Digital Eingang und mindestens 60,0 Hz Bildwiederholfrequenz, non interlaced. Weiterhin wird aus ergonomischen Gründen empfohlen, die Grundfarbe Blau nicht auf dunklem Untergrund zu verwenden (schlechte Erkennbarkeit, Augenbelastung bei zu geringem Zeichenkontrast.)

„Maschinenlärminformations-Verordnung 3. GPSGV:

Der höchste Schalldruckpegel beträgt 70 dB(A) oder weniger gemäss EN ISO 7779“

